

Low Noise Silicon Bipolar RF Transistor

- General purpose low noise amplifier for low voltage, low current applications
- High ESD robustness, typical 1500 V (HBM)
- Low minimum noise figure 1.1 dB at 1.8 GHz
- High linearity: output compression point
OP1dB = 13 dBm @ 3 V, 35 mA, 1.8 GHz
- Pb-free (RoHS compliant) and halogen-free package with visible leads
- Qualification report according to AEC-Q101 available



ESD (Electrostatic discharge) sensitive device, observe handling precaution!

Type	Marking	Pin Configuration						Package
BFP460	ABs	1 = E	2 = C	3 = E	4=B	-	-	SOT343

Maximum Ratings at $T_A = 25\text{ }^\circ\text{C}$, unless otherwise specified

Parameter	Symbol	Value	Unit
Collector-emitter voltage $T_A = 25\text{ }^\circ\text{C}$ $T_A = -55\text{ }^\circ\text{C}$	V_{CEO}	4.5 4.2	V
Collector-emitter voltage	V_{CES}	15	
Collector-base voltage	V_{CBO}	15	
Emitter-base voltage	V_{EBO}	1.5	
Collector current	I_C	70	mA
Base current	I_B	7	
Total power dissipation ¹⁾ $T_S \leq 92\text{ }^\circ\text{C}$	P_{tot}	230	mW
Junction temperature	T_J	150	$^\circ\text{C}$
Ambient temperature	T_A	-65 ... 150	
Storage temperature	T_{Stg}	-65 ... 150	

¹⁾ T_S is measured on the collector lead at the soldering point to the pcb

Thermal Resistance

Parameter	Symbol	Value	Unit
Junction - soldering point ¹⁾	R_{thJS}	250	K/W

Electrical Characteristics at $T_A = 25\text{ °C}$, unless otherwise specified

Parameter	Symbol	Values			Unit
		min.	typ.	max.	

DC Characteristics

Collector-emitter breakdown voltage $I_C = 1\text{ mA}$, $I_B = 0$	$V_{(BR)CEO}$	4.5	5.8	-	V
Collector-emitter cutoff current $V_{CE} = 15\text{ V}$, $V_{BE} = 0$ $V_{CE} = 2\text{ V}$, $V_{BE} = 0$ $V_{CE} = 5\text{ V}$, $V_{BE} = 0$, $T_A = 85\text{ °C}$ Verified by random sampling	I_{CES}	-	-	1000	nA
Collector-base cutoff current $V_{CB} = 2\text{ V}$, $I_E = 0$ $V_{CB} = 5\text{ V}$, $I_E = 0$	I_{CBO}	-	1	30	
Emitter-base cutoff current $V_{EB} = 0,5\text{ V}$, $I_C = 0$	I_{EBO}	-	1	500	
DC current gain $V_{CE} = 3\text{ V}$, $I_C = 20\text{ mA}$, pulse measured	h_{FE}	90	120	160	-

¹⁾For the definition of R_{thJS} please refer to Application Note AN077 (Thermal Resistance Calculation)

Electrical Characteristics at $T_A = 25\text{ }^\circ\text{C}$, unless otherwise specified

Parameter	Symbol	Values			Unit
		min.	typ.	max.	
AC Characteristics (verified by random sampling)					
Transition frequency $I_C = 30\text{ mA}$, $V_{CE} = 3\text{ V}$, $f = 1\text{ GHz}$	f_T	16	22	-	GHz
Collector-base capacitance $V_{CB} = 3\text{ V}$, $f = 1\text{ MHz}$, $V_{BE} = 0$, emitter grounded	C_{cb}	-	0.32	0.45	pF
Collector emitter capacitance $V_{CE} = 3\text{ V}$, $f = 1\text{ MHz}$, $V_{BE} = 0$, base grounded	C_{ce}	-	0.28	-	
Emitter-base capacitance $V_{EB} = 0.5\text{ V}$, $f = 1\text{ MHz}$, $V_{CB} = 0$, collector grounded	C_{eb}	-	0.55	-	
Minimum noise figure $V_{CE} = 2\text{ V}$, $I_C = 3\text{ mA}$, $Z_S = Z_{Sopt}$, $f = 100\text{ MHz}$ $V_{CE} = 3\text{ V}$, $I_C = 5\text{ mA}$, $Z_S = Z_{Sopt}$, $f = 1.8\text{ GHz}$ $V_{CE} = 3\text{ V}$, $I_C = 5\text{ mA}$, $Z_S = Z_{Sopt}$, $f = 3\text{ GHz}$	NF_{min}	-	0.7 1.1 1.2	-	dB

Electrical Characteristics at $T_A = 25\text{ }^\circ\text{C}$, unless otherwise specified

Parameter	Symbol	Values			Unit
		min.	typ.	max.	
AC Characteristics (verified by random sampling)					
Maximum power Gain ¹⁾ $I_C = 3\text{ mA}$, $V_{CE} = 1.5\text{ V}$, $Z_S = Z_{Sopt}$, $Z_L = Z_{Lopt}$, $f = 100\text{ MHz}$ $I_C = 20\text{ mA}$, $V_{CE} = 3\text{ V}$, $Z_S = Z_{Sopt}$, $Z_L = Z_{Lopt}$, $f = 1,8\text{ GHz}$ $f = 3\text{ GHz}$	G_{max}	- - -	26.5 17.5 12.5	- - -	dB
Transducer gain $I_C = 3\text{ mA}$, $V_{CE} = 1.5\text{ V}$, $Z_S = Z_L = 50\Omega$, $f = 100\text{ MHz}$ $I_C = 20\text{ mA}$, $V_{CE} = 3\text{ V}$, $Z_S = Z_L = 50\Omega$, $f = 1.8\text{ GHz}$ $f = 3\text{ GHz}$	$ S_{21e} ^2$	- - -	20 15 10.5	- - -	dB
Third order intercept point at output ²⁾ $V_{CE} = 3\text{ V}$, $I_C = 20\text{ mA}$, $f = 100\text{ MHz}$ $V_{CE} = 3\text{ V}$, $I_C = 20\text{ mA}$, $f = 1.8\text{ GHz}$	$IP3$	- -	23.5 27.5	- -	dBm
1dB compression point at output $V_{CE} = 3\text{ V}$, $I_C = 20\text{ mA}$, $Z_S = Z_L = 50\Omega$, $f = 100\text{ MHz}$ $V_{CE} = 3\text{ V}$, $I_C = 20\text{ mA}$, $Z_S = Z_L = 50\Omega$, $f = 1.8\text{ GHz}$ $V_{CE} = 3\text{ V}$, $I_C = 35\text{ mA}$, $Z_S = Z_L = 50\Omega$, $f = 1.8\text{ GHz}$	P_{-1dB}	- - -	9.5 11.5 13	- - -	

$$^1G_{ma} = |S_{21} / S_{12}| (k - (k^2 - 1)^{1/2}), G_{ms} = |S_{21} / S_{12}|$$

²IP3 value depends on termination of all intermodulation frequency components.

Termination used for this measurement is 50Ω from 0.1 MHz to 6 GHz

Total power dissipation $P_{tot} = f(T_S)$

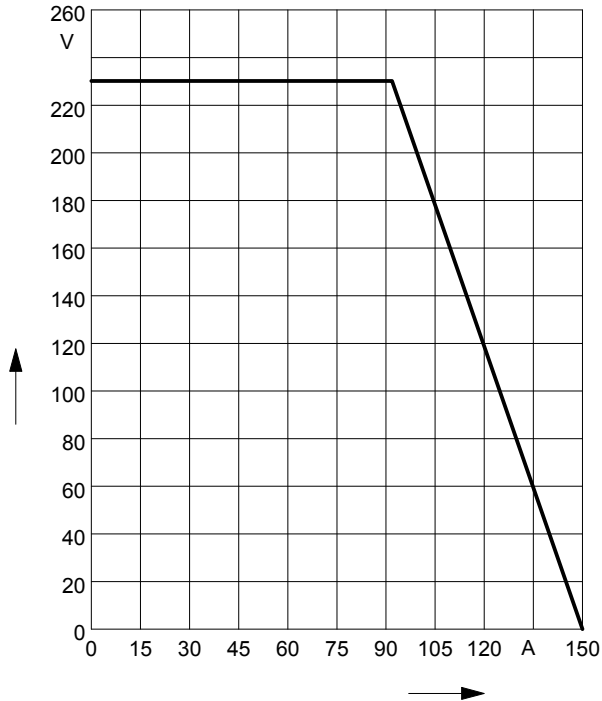

Collector-base capacitance $C_{cb} = f(V_{CB})$
 $f = 1\text{MHz}$

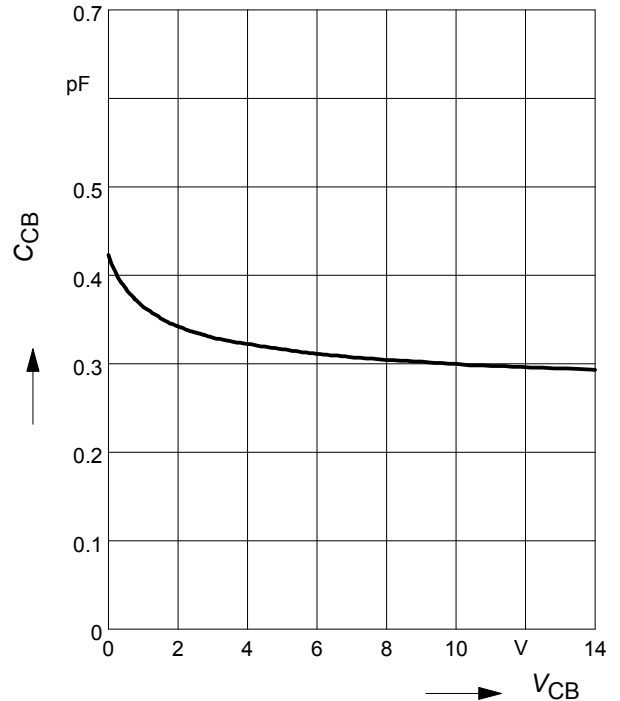

Third order Intercept Point $IP3 = f(I_C)$

(Output, $Z_S = Z_L = 50\Omega$)

$V_{CE} = \text{parameter}, f = 1800\text{MHz}$

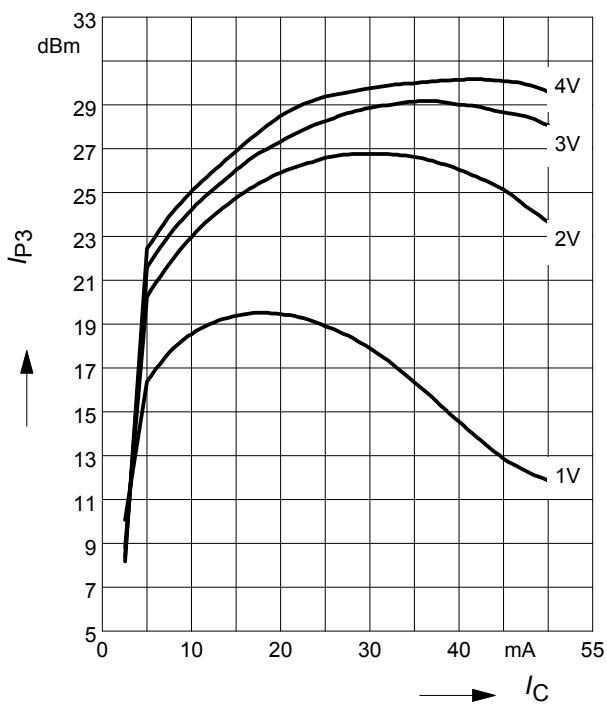

Transition frequency $f_T = f(I_C)$

$f = 1\text{GHz}$

$V_{CE} = \text{parameter}$

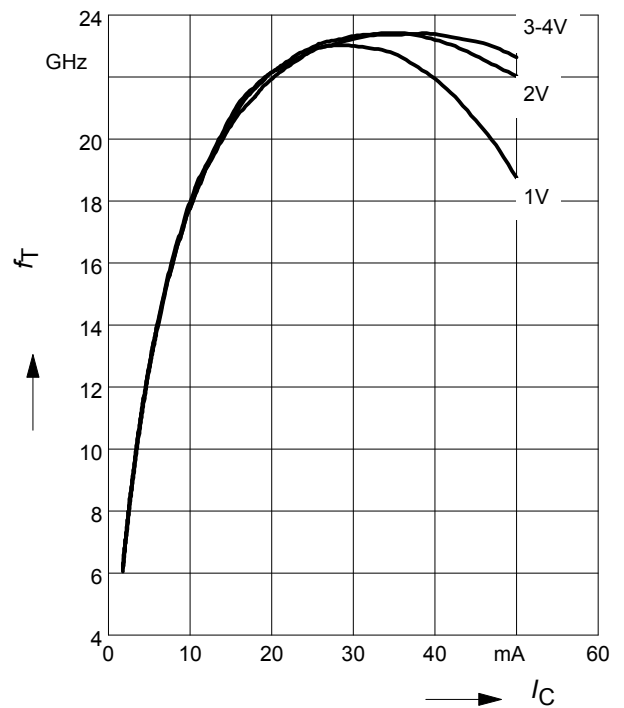

Power gain G_{ma} , G_{ms} , $|S_{21}|^2 = f(f)$

$V_{CE} = 3\text{ V}$, $I_C = 20\text{ mA}$

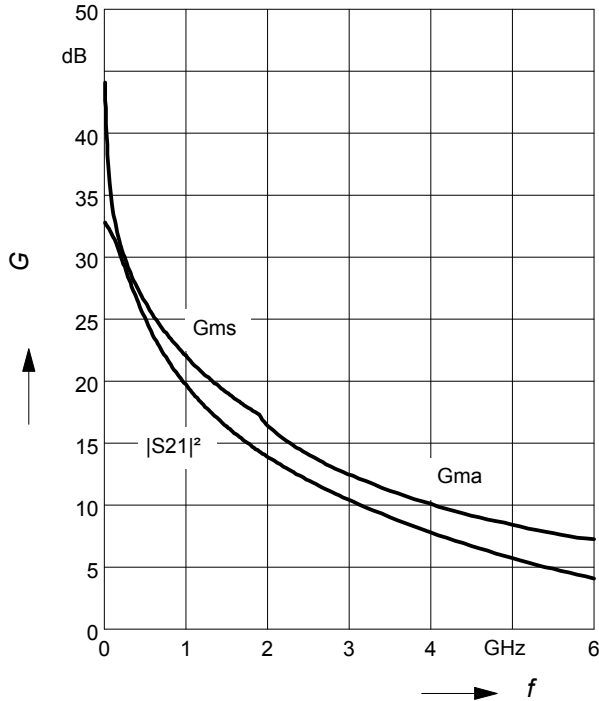

Power gain G_{ma} , $G_{ms} = f(I_C)$

$V_{CE} = 3\text{ V}$

$f = \text{parameter in GHz}$

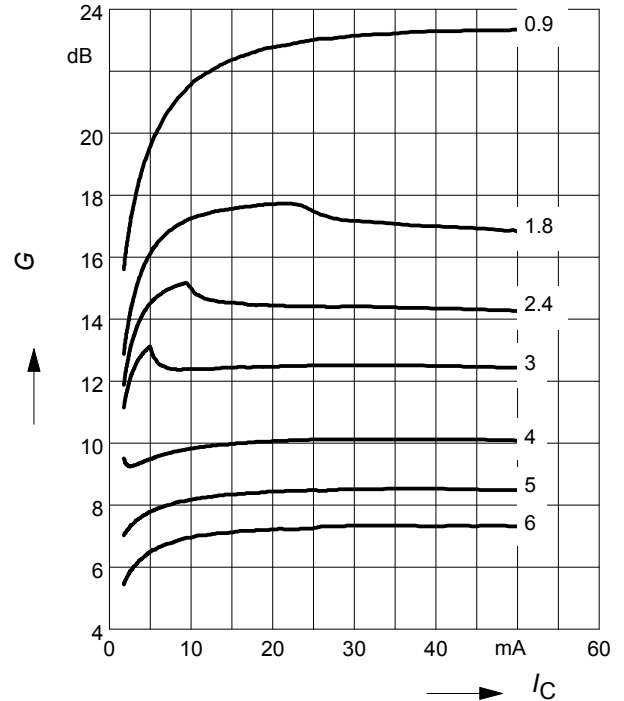

Power gain G_{ma} , $G_{ms} = f(V_{CE})$

$I_C = 20\text{ mA}$

$f = \text{parameter in GHz}$

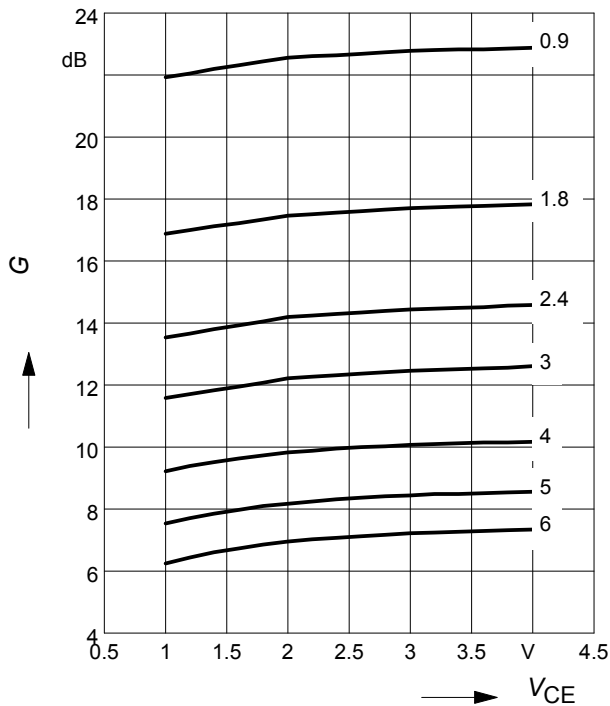

Noise figure $F = f(I_C)$

$V_{CE} = 2\text{ V}$, $f = \text{parameter}$

$Z_S = Z_{\text{Sopt}}$

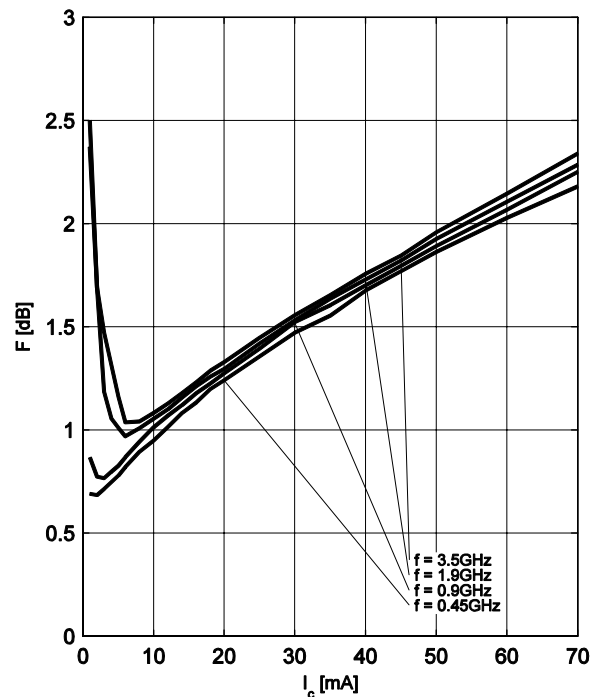

Third order Intercept Point $IP_3 = f(I_C)$

(Output, $Z_S = Z_L = 50\Omega$)

$V_{CE} = \text{parameter}$, $f = 100\text{MHz}$

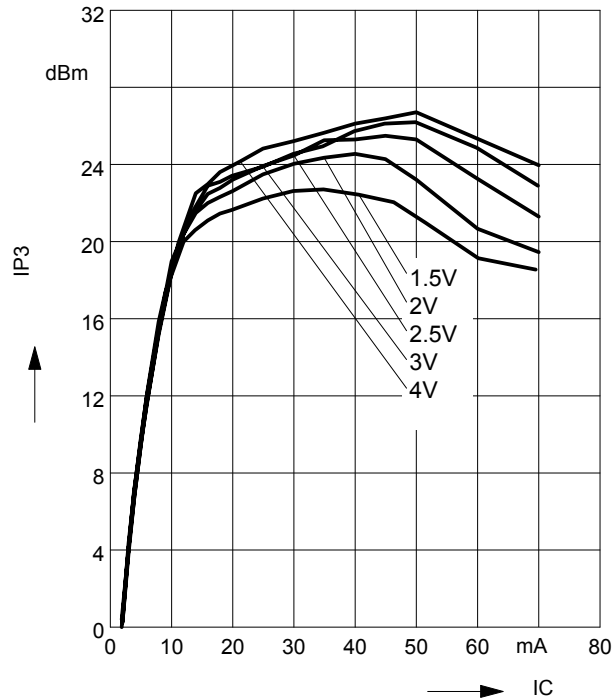

Noise figure $F = f(f)$

$V_{CE} = 2\text{V}$, $Z_S = Z_{\text{Sopt}}$, $I_C = \text{parameter}$

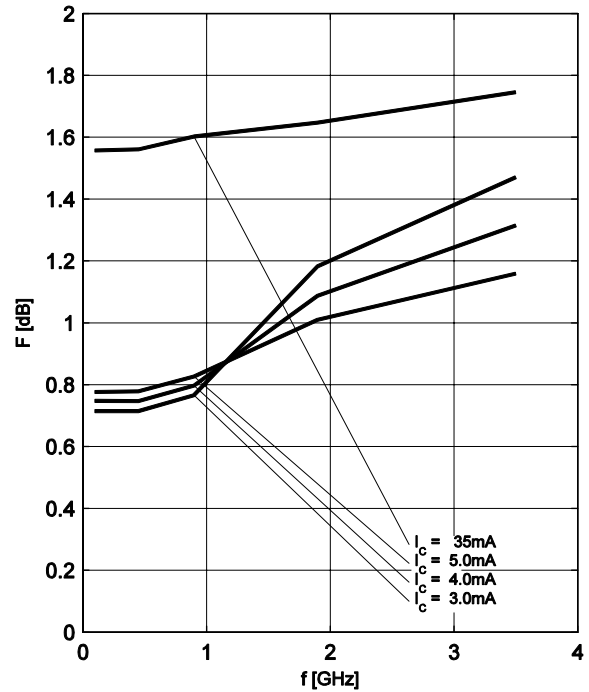

Source impedance for min.

noise figure vs. frequency

$V_{CE} = 2\text{V}$, $I_C = \text{parameter}$

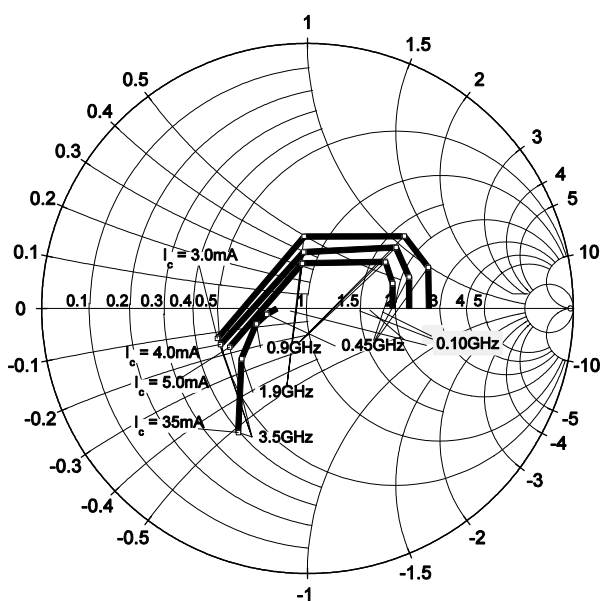

SPICE GP Model

For the SPICE Gummel Poon (GP) model as well as for the S-parameters (including noise parameters) please refer to our internet website www.infineon.com/rf.models.

Please consult our website and download the latest versions before actually starting your design. You find the BFP460 SPICE GP model in the internet in MWO- and ADS-format, which you can import into these circuit simulation tools very quickly and conveniently. The model already contains the package parasitics and is ready to use for DC and high frequency simulations. The terminals of the model circuit correspond to the pin configuration of the device. The model parameters have been extracted and verified up to 6 GHz using typical devices. The BFP460 SPICE GP model reflects the typical DC- and RF-performance within the limitations which are given by the SPICE GP model itself. Besides the DC characteristics all S-parameters in magnitude and phase, as well as noise figure (including optimum source impedance, equivalent noise resistance and flicker noise) and intermodulation have been extracted.

Package Outline

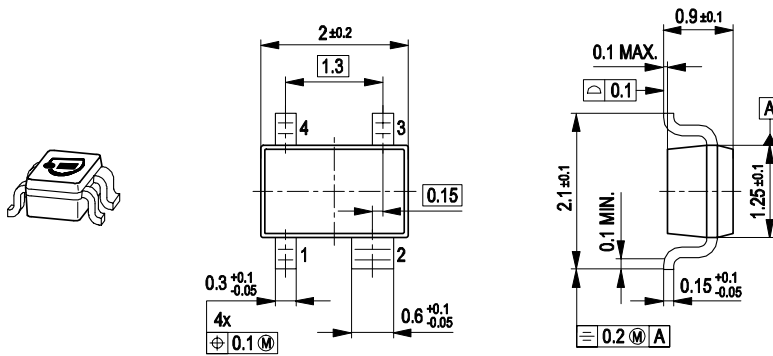

Foot Print

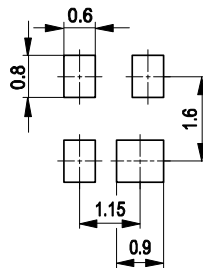

Marking Layout (Example)

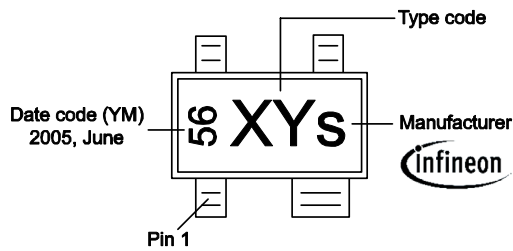

Standard Packing

Reel ø180 mm = 3.000 Pieces/Reel
 Reel ø330 mm = 10.000 Pieces/Reel

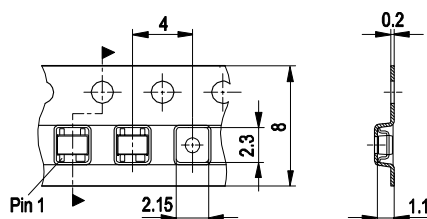

Edition 2009-11-16

**Published by
Infineon Technologies AG
81726 Munich, Germany**

**© 2009 Infineon Technologies AG
All Rights Reserved.**

Legal Disclaimer

The information given in this document shall in no event be regarded as a guarantee of conditions or characteristics. With respect to any examples or hints given herein, any typical values stated herein and/or any information regarding the application of the device, Infineon Technologies hereby disclaims any and all warranties and liabilities of any kind, including without limitation, warranties of non-infringement of intellectual property rights of any third party.

Information

For further information on technology, delivery terms and conditions and prices, please contact the nearest Infineon Technologies Office (www.infineon.com).

Warnings

Due to technical requirements, components may contain dangerous substances. For information on the types in question, please contact the nearest Infineon Technologies Office.

Infineon Technologies components may be used in life-support devices or systems only with the express written approval of Infineon Technologies, if a failure of such components can reasonably be expected to cause the failure of that life-support device or system or to affect the safety or effectiveness of that device or system. Life support devices or systems are intended to be implanted in the human body or to support and/or maintain and sustain and/or protect human life. If they fail, it is reasonable to assume that the health of the user or other persons may be endangered.

单击下面可查看定价，库存，交付和生命周期等信息

[>>Infineon Technologies\(英飞凌\)](#)