

IR2301(S) & (PbF)

Absolute Maximum Ratings

Absolute maximum ratings indicate sustained limits beyond which damage to the device may occur. All voltage parameters are absolute voltages referenced to COM. The thermal resistance and power dissipation ratings are measured under board mounted and still air conditions.

Symbol	Definition	Min.	Max.	Units	
V _B	High side floating absolute voltage	-0.3	625	V	
V _S	High side floating supply offset voltage	V _B - 25	V _B + 0.3		
V _{HO}	High side floating output voltage	V _S - 0.3	V _B + 0.3		
V _{CC}	Low side and logic fixed supply voltage	-0.3	25		
V _{LO}	Low side output voltage	-0.3	V _{CC} + 0.3		
V _{IN}	Logic input voltage	COM - 0.3	V _{CC} + 0.3		
dV _S /dt	Allowable offset supply voltage transient	—	50	V/ns	
P _D	Package power dissipation @ T _A ≤ +25°C	(8 lead PDIP)	—	1.0	W
		(8 lead SOIC)	—	0.625	
R _{thJA}	Thermal resistance, junction to ambient	(8 lead PDIP)	—	125	°C/W
		(8 lead SOIC)	—	200	
T _J	Junction temperature	—	150	°C	
T _S	Storage temperature	-50	150		
T _L	Lead temperature (soldering, 10 seconds)	—	300		

Recommended Operating Conditions

The Input/Output logic timing diagram is shown in figure 1. For proper operation the device should be used within the recommended conditions. The V_S offset rating is tested with all supplies biased at 15V differential.

Symbol	Definition	Min.	Max.	Units
V _B	High side floating supply absolute voltage	V _S + 5	V _S + 20	V
V _S	High side floating supply offset voltage	Note 1	600	
V _{HO}	High side floating output voltage	V _S	V _B	
V _{CC}	Low side and logic fixed supply voltage	5	20	
V _{LO}	Low side output voltage	0	V _{CC}	
V _{IN}	Logic input voltage	COM	V _{CC}	
T _A	Ambient temperature	-40	150	°C

Note 1: Logic operational for V_S of -5 to +600V. Logic state held for V_S of -5V to -V_{BS}. (Please refer to the Design Tip DT97-3 for more details).

Dynamic Electrical Characteristics

$V_{BIAS} (V_{CC}, V_{BS}) = 15V, C_L = 1000 \text{ pF}, T_A = 25^\circ\text{C}.$

Symbol	Definition	Min.	Typ.	Max.	Units	Test Conditions
t_{on}	Turn-on propagation delay	—	220	300	nsec	$V_S = 0V$
t_{off}	Turn-off propagation delay	—	200	280		$V_S = 0V \text{ or } 600V$
MT	Delay matching, HS & LS turn-on/off	—	0	50		
t_r	Turn-on rise time	—	130	220		$V_S = 0V$
t_f	Turn-off fall time	—	50	80		$V_S = 0V$

Static Electrical Characteristics

$V_{BIAS} (V_{CC}, V_{BS}) = 15V,$ and $T_A = 25^\circ\text{C}$ unless otherwise specified. The V_{IL}, V_{IH} and I_{IN} parameters are referenced to COM and are applicable to the respective input leads. The V_O, I_O and R_{on} parameters are referenced to COM and are applicable to the respective output leads: HO and LO.

Symbol	Definition	Min.	Typ.	Max.	Units	Test Conditions
V_{IH}	Logic "1" input voltage	2.9	—	—	V	$V_{CC} = 10V \text{ to } 20V$
V_{IL}	Logic "0" input voltage	—	—	0.8		$V_{CC} = 10V \text{ to } 20V$
V_{OH}	High level output voltage, $V_{BIAS} - V_O$	—	0.8	1.4		$I_O = 20 \text{ mA}$
V_{OL}	Low level output voltage, V_O	—	0.3	0.6		$I_O = 20 \text{ mA}$
I_{LK}	Offset supply leakage current	—	—	50	μA	$V_B = V_S = 600V$
I_{QBS}	Quiescent V_{BS} supply current	20	60	100		$V_{IN} = 0V \text{ or } 5V$
I_{QCC}	Quiescent V_{CC} supply current	50	120	190		$V_{IN} = 0V \text{ or } 5V$
I_{IN+}	Logic "1" input bias current	—	5	20		$V_{IN} = 5V$
I_{IN-}	Logic "0" input bias current	—	—	2		$V_{IN} = 0V$
V_{CCUV+} V_{BSUV+}	V_{CC} and V_{BS} supply undervoltage positive going threshold	3.3	4.1	5	V	
V_{CCUV-} V_{BSUV-}	V_{CC} and V_{BS} supply undervoltage negative going threshold	3	3.8	4.7		
V_{CCUVH} V_{BSUVH}	Hysteresis	0.1	0.3	—		
I_{O+}	Output high short circuit pulsed current	120	200	—	mA	$V_O = 0V,$ $PW \leq 10 \mu\text{s}$
I_{O-}	Output low short circuit pulsed current	250	350	—		$V_O = 15V,$ $PW \leq 10 \mu\text{s}$

Functional Block Diagrams

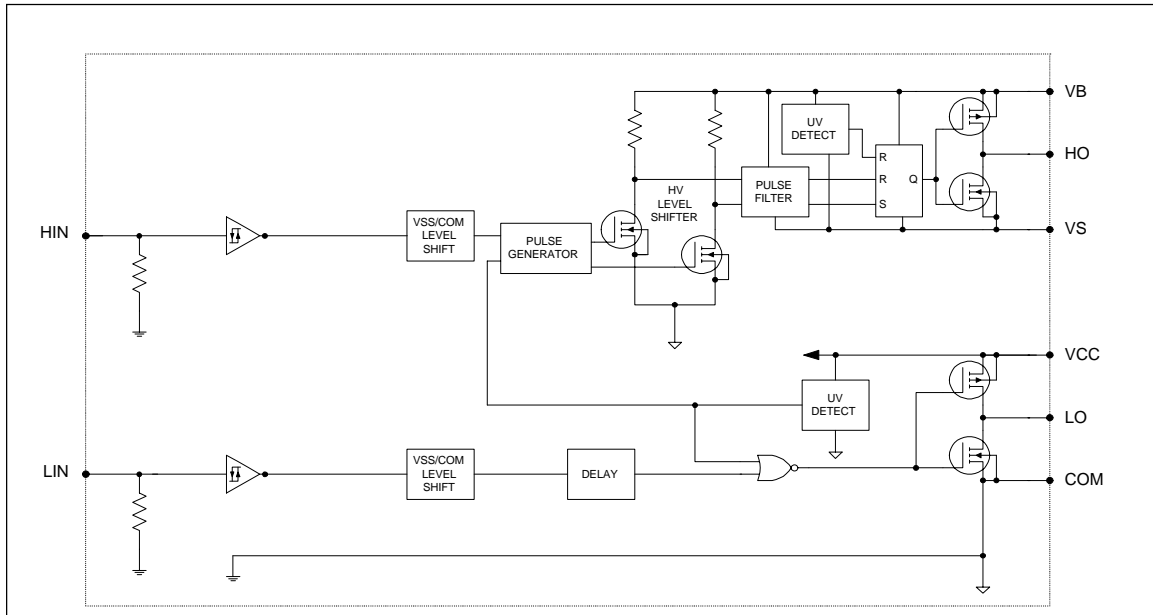

Lead Definitions

Symbol	Description
HIN	Logic input for high side gate driver output (HO), in phase
LIN	Logic input for low side gate driver output (LO), in phase
VB	High side floating supply
HO	High side gate drive output
VS	High side floating supply return
VCC	Low side and logic fixed supply
LO	Low side gate drive output
COM	Low side return

Lead Assignments

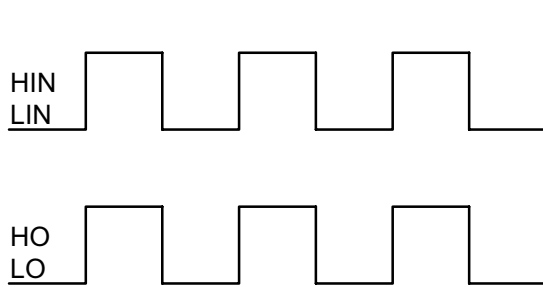
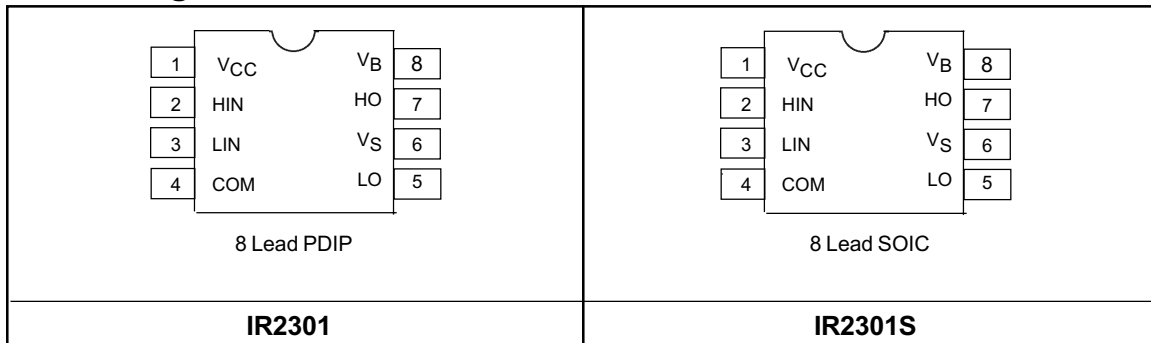

Figure 1. Input/Output Timing Diagram

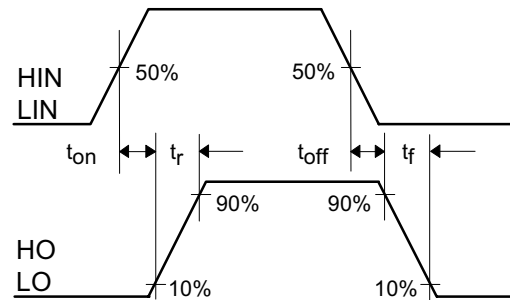

Figure 2. Switching Time Waveform Definitions

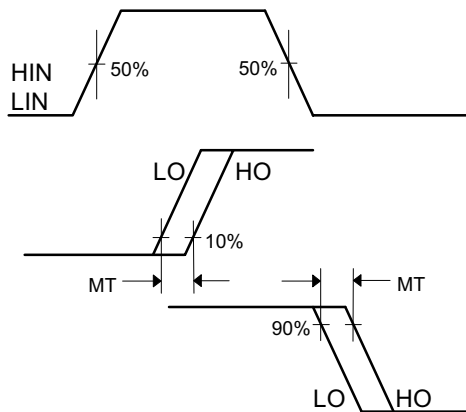

Figure 3. Delay Matching Waveform Definitions

IR2301(S) & (PbF)

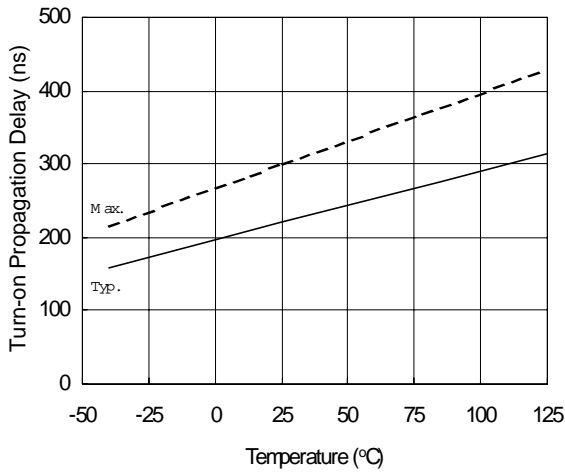

Figure 4A. Turn-on Propagation Delay vs. Temperature

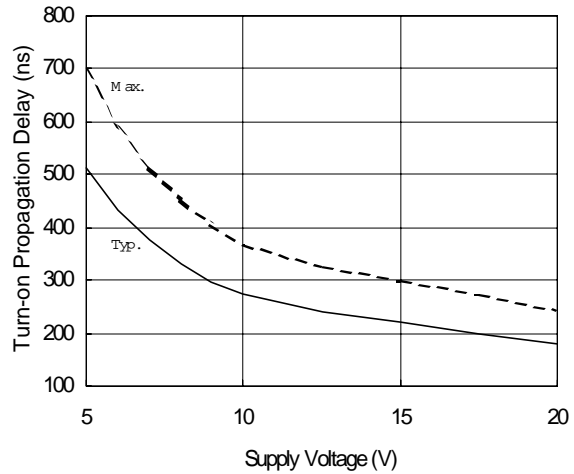

Figure 4B. Turn-on Propagation Delay vs. Supply Voltage

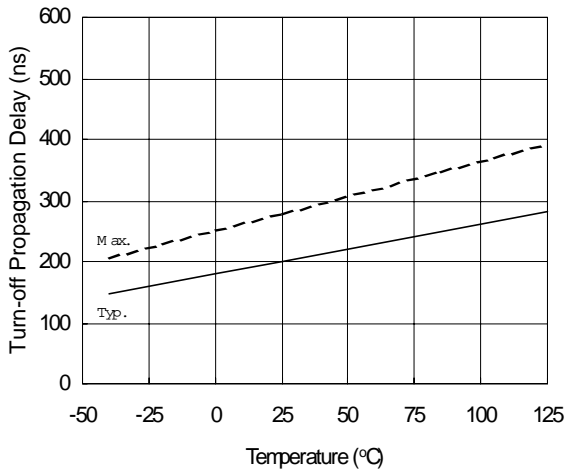

Figure 5A. Turn-off Propagation Delay vs. Temperature

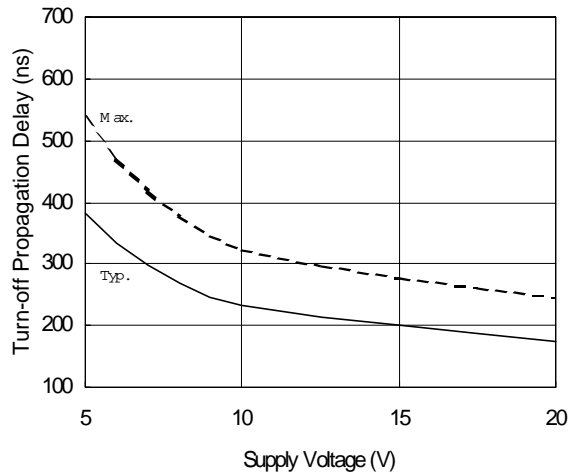

Figure 5B. Turn-off Propagation Delay vs. Supply Voltage

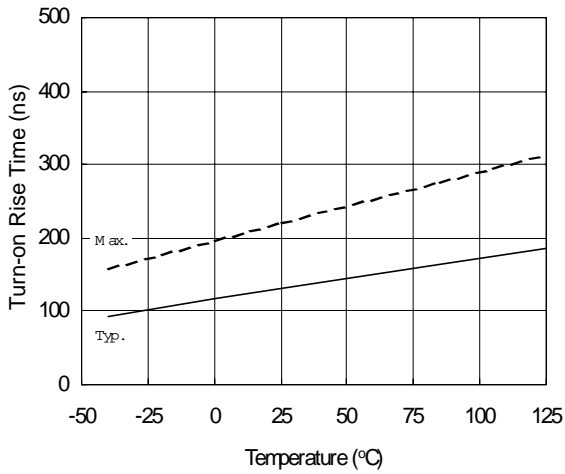

Figure 6A. Turn-on Rise Time vs. Temperature

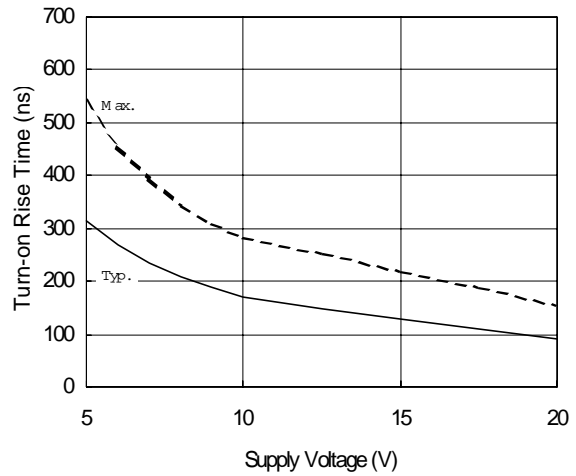

Figure 6B. Turn-on Rise Time vs. Supply Voltage

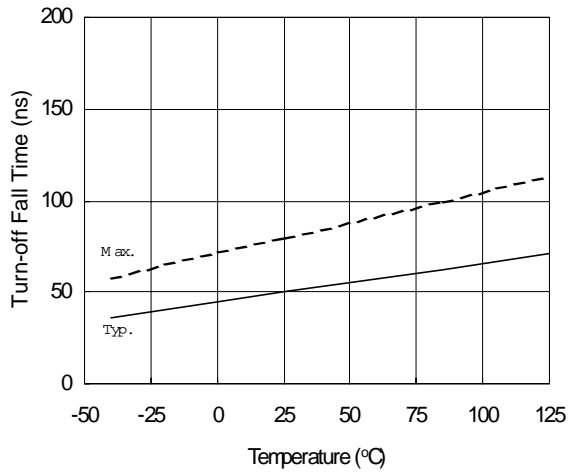

Figure 7A. Turn-off Fall Time vs. Temperature

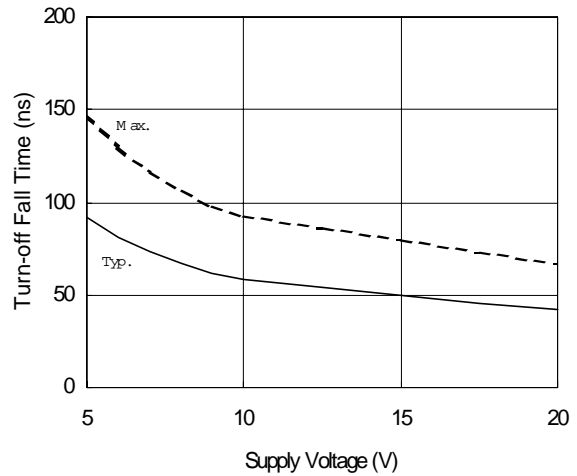

Figure 7B. Turn-off Fall Time vs. Supply Voltage

IR2301(S) & (PbF)

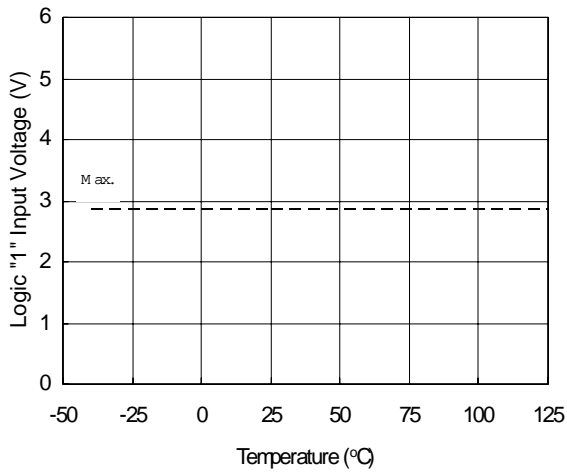

Figure 8A. Logic "1" Input Voltage vs. Temperature

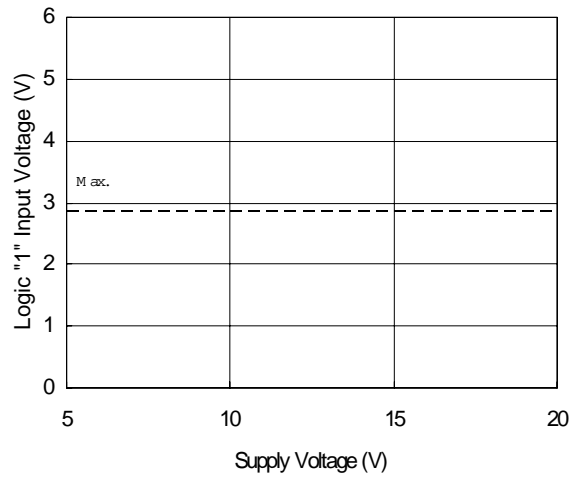

Figure 8B. Logic "1" Input Voltage vs. Supply Voltage

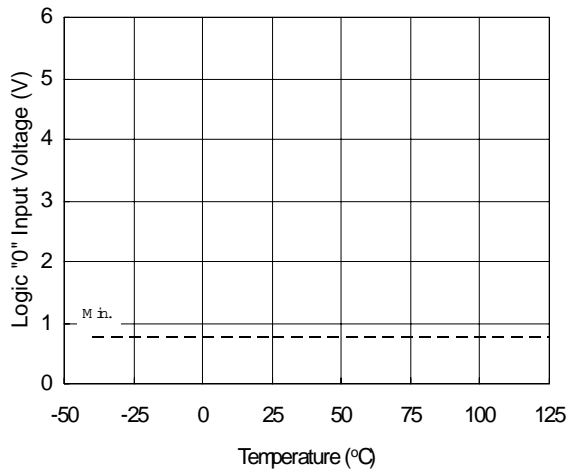

Figure 9A. Logic "0" Input Voltage vs. Temperature

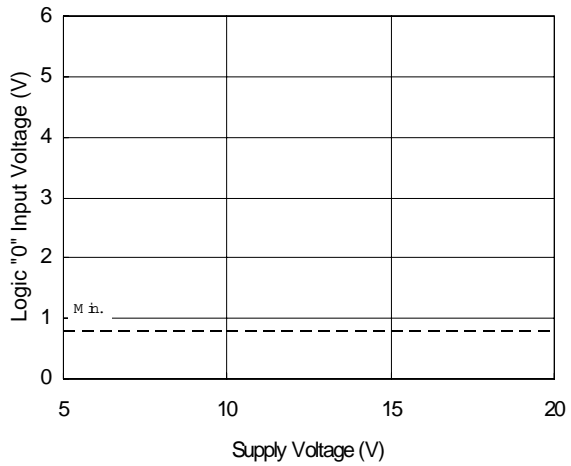

Figure 9B. Logic "0" Input Voltage vs. Supply Voltage

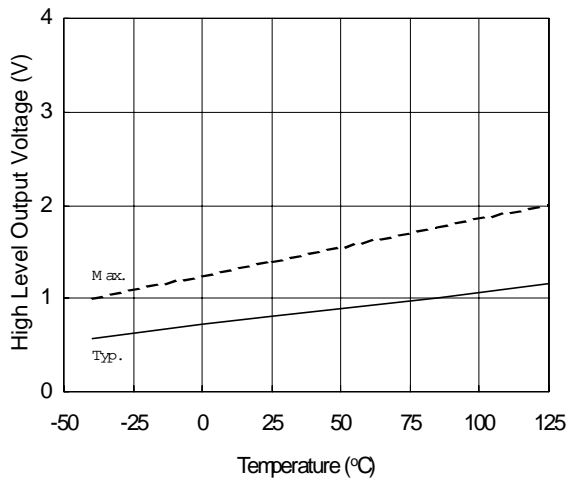

Figure 10A. High Level Output Voltage vs. Temperature

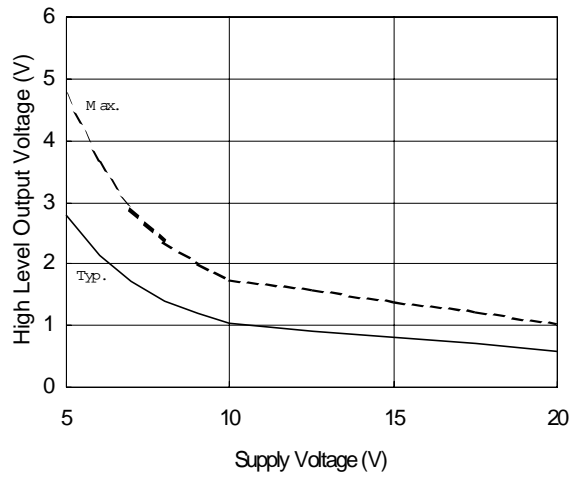

Figure 10B. High Level Output Voltage vs. Supply Voltage

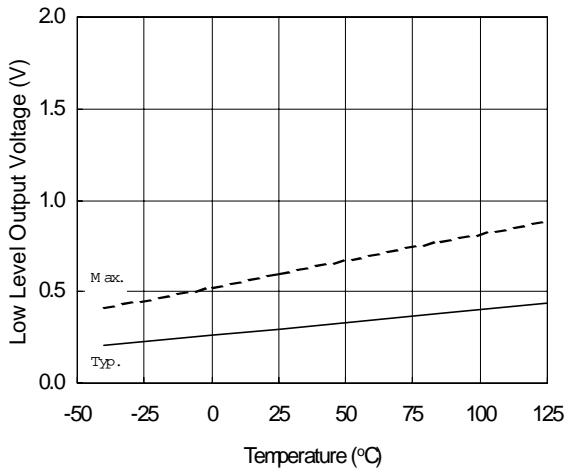

Figure 11A. Low Level Output Voltage vs. Temperature

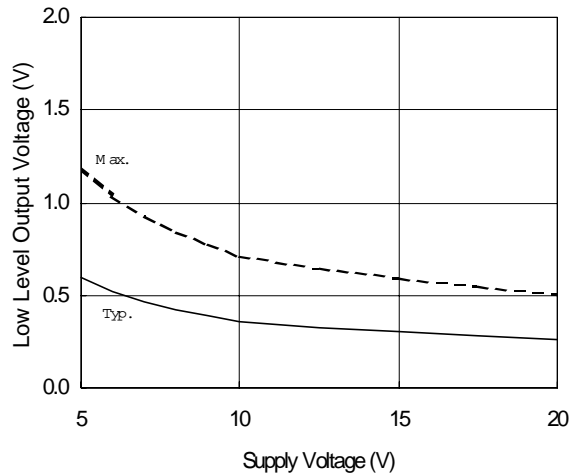

Figure 11B. Low Level Output Voltage vs. Supply Voltage

IR2301(S) & (PbF)

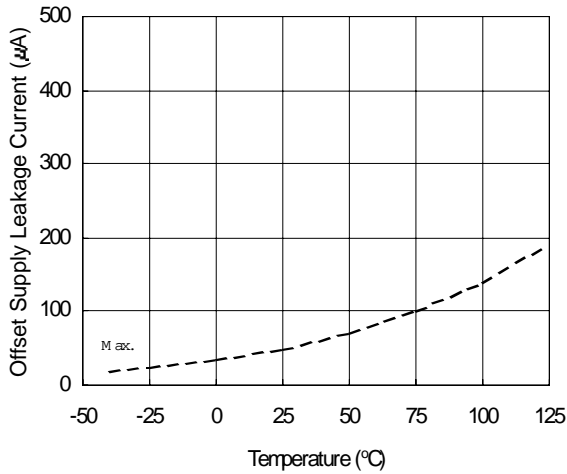

Figure 12A. Offset Supply Leakage Current vs. Temperature

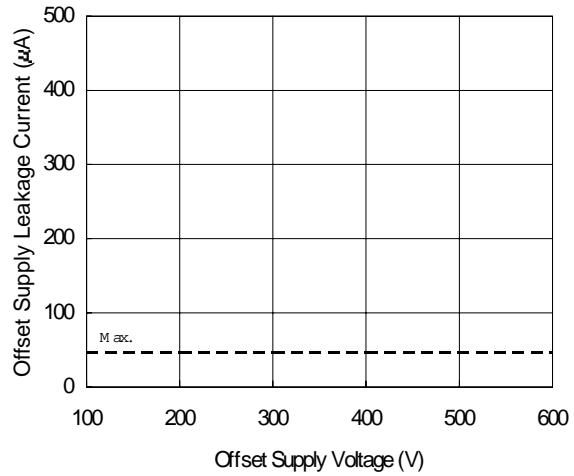

Figure 12B. Offset Supply Leakage Current vs. Supply Voltage

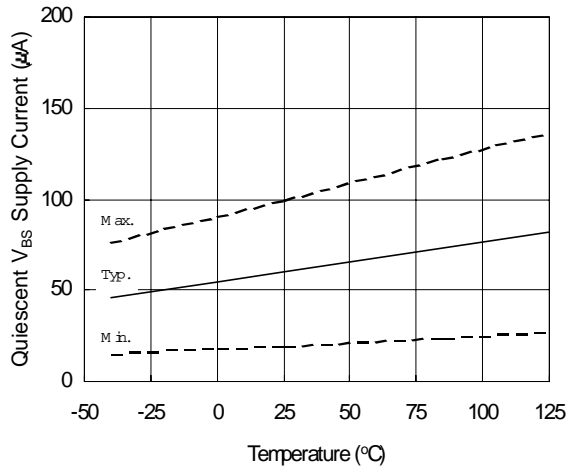

Figure 13A. Quiescent VBS Supply Current vs. Temperature

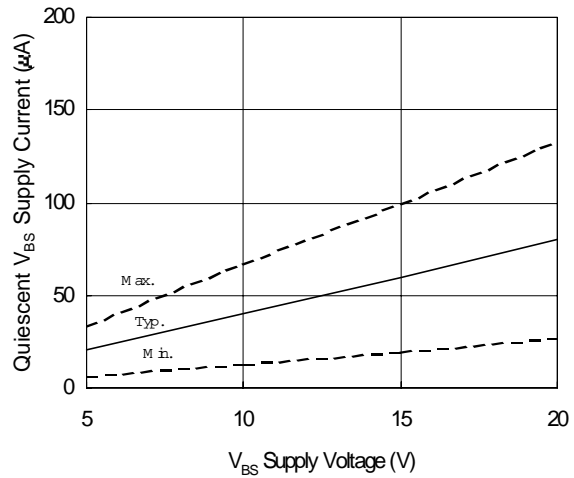

Figure 13B. Quiescent VBS Supply Current vs. Supply Voltage

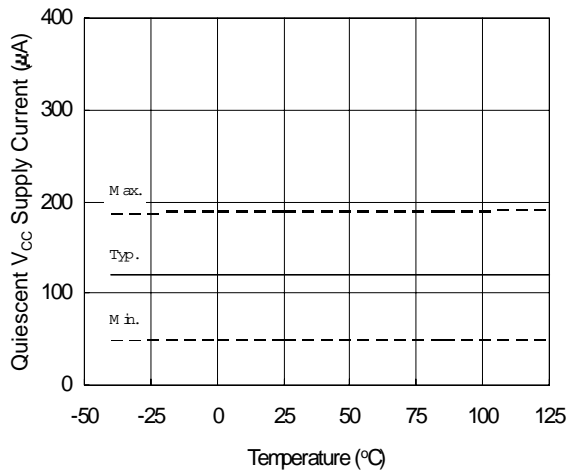

Figure 14A. Quiescent V_{CC} Supply Current vs. Temperature

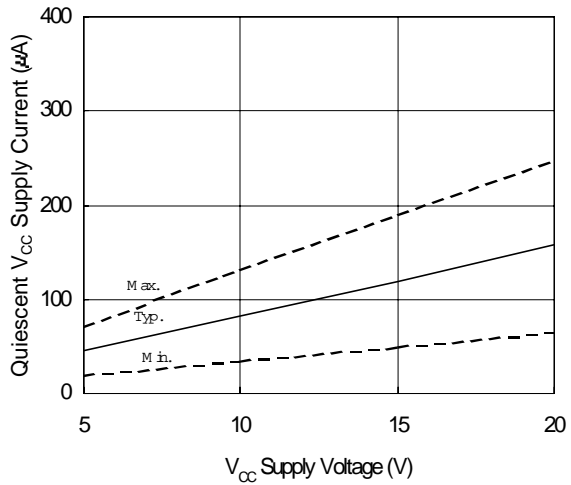

Figure 14B. Quiescent V_{CC} Supply Current vs. V_{CC} Supply Voltage

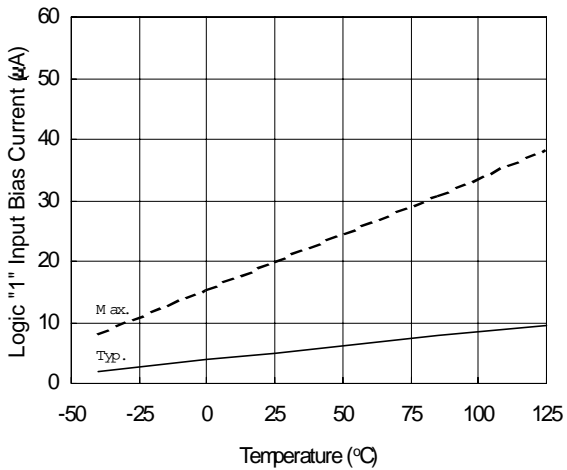

Figure 15A. Logic "1" Input Bias Current vs. Temperature



Figure 15B. Logic "1" Input Bias Current vs. Supply Voltage

IR2301(S) & (PbF)

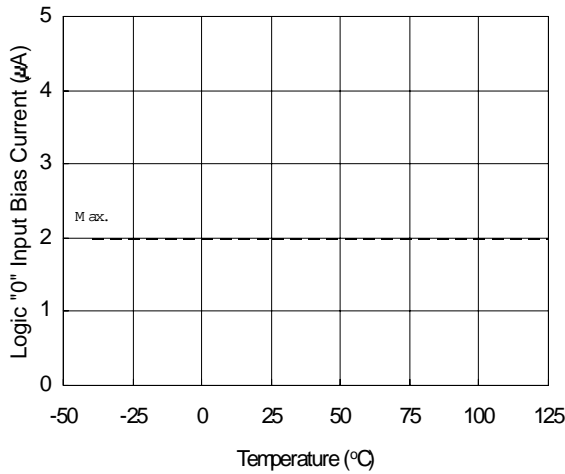

Figure 16A. Logic "0" Input Bias Current vs. Temperature

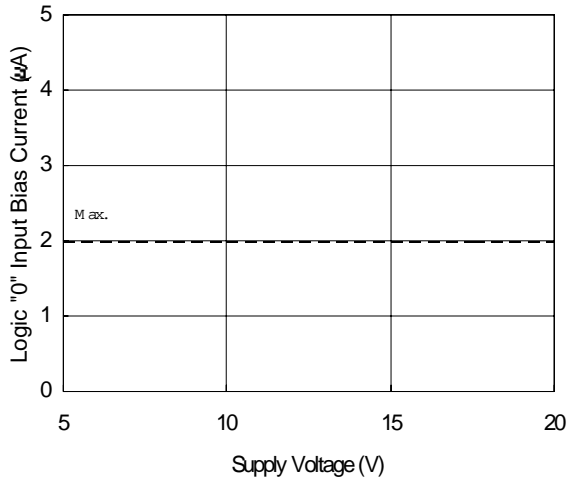

Figure 16B. Logic "0" Input Bias Current vs. Supply Voltage

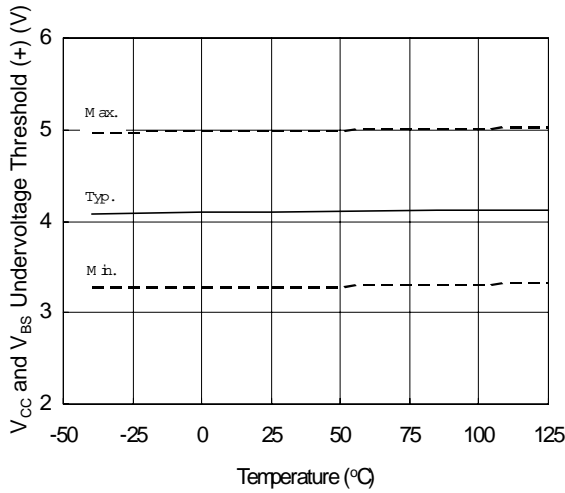

Figure 17. V_{CC} and V_{BS} Undervoltage Threshold (+) vs. Temperature

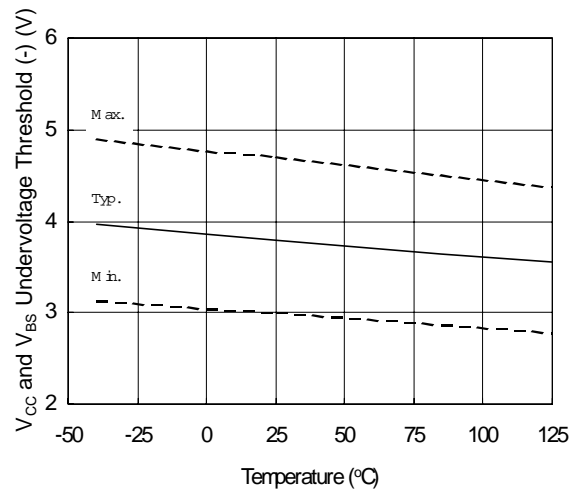

Figure 18. V_{CC} and V_{BS} Undervoltage Threshold (-) vs. Temperature

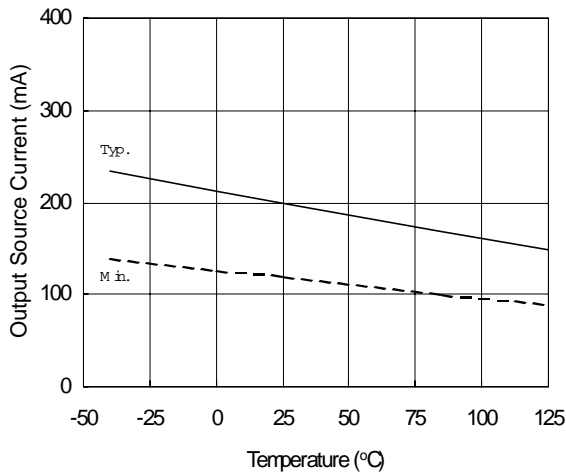

Figure 19A. Output Source Current vs. Temperature

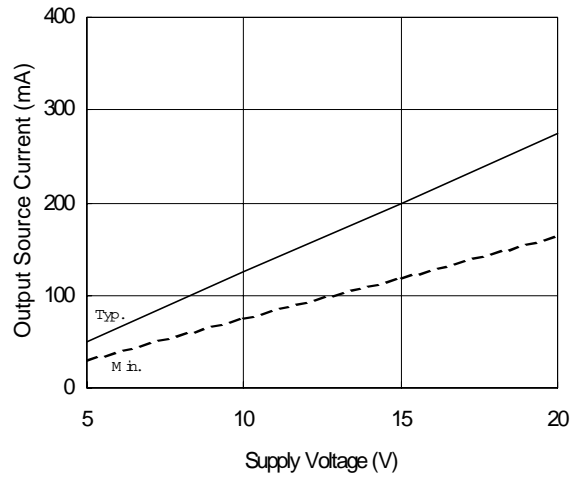

Figure 19B. Output Source Current vs. Supply Voltage

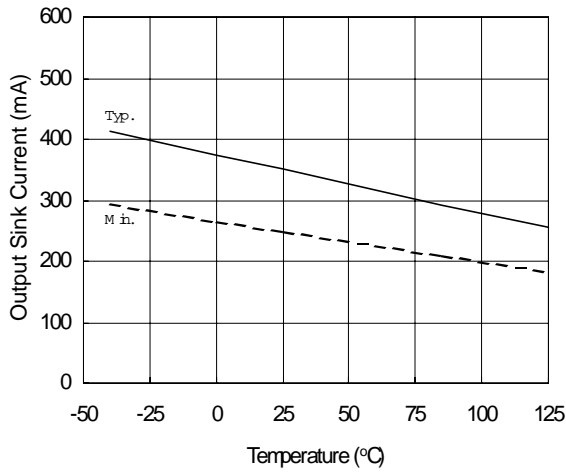

Figure 20A. Output Sink Current vs. Temperature

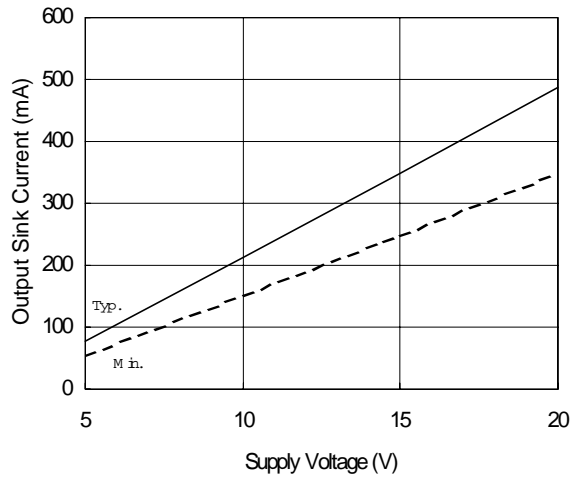

Figure 20B. Output Sink Current vs. Supply Voltage

IR2301(S) & (PbF)

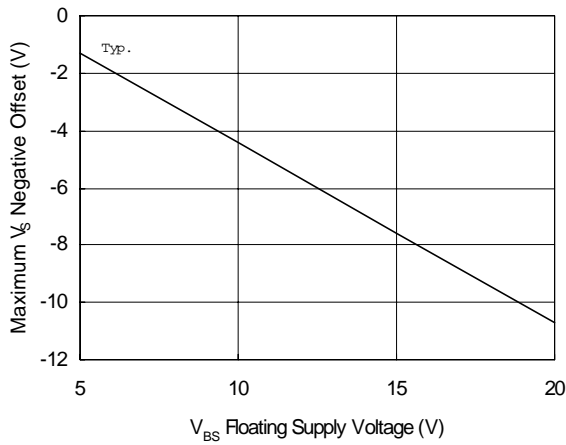

Figure 21. Maximum V_S Negative Offset vs. V_{BS} Floating Supply Voltage

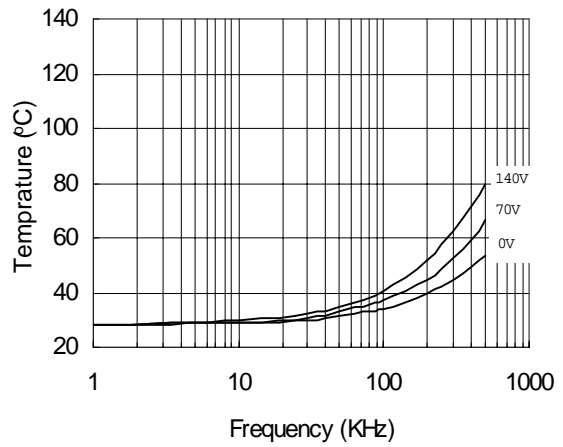

Figure 22. IR2301 vs. Frequency (IRFBC20),
R_{gate}=33Ω, V_{CC}=15V

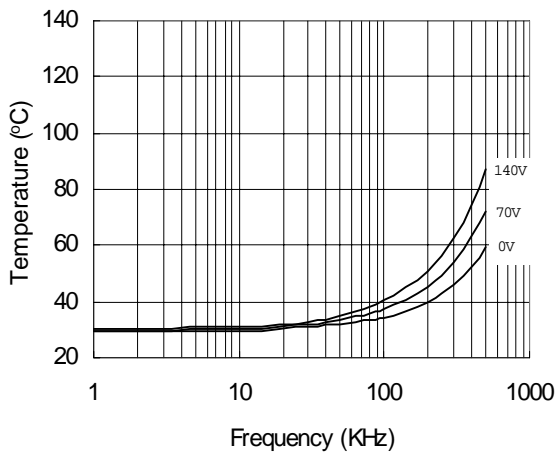

Figure 23. IR2301 vs. Frequency (IRFBC30),
R_{gate}=22Ω, V_{CC}=15V

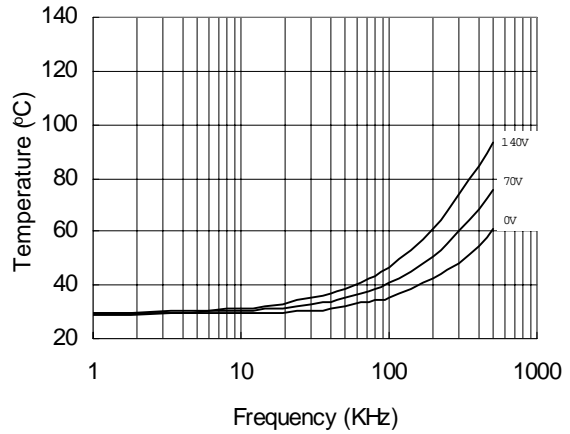

Figure 24. IR2301 vs. Frequency (IRFBC40),
R_{gate}=15Ω, V_{CC}=15V

IR2301(S) & (PbF)

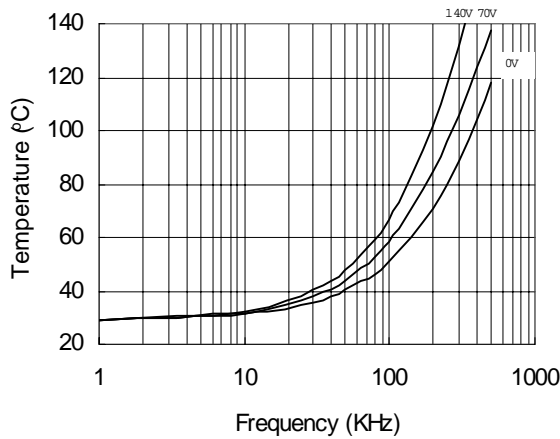

Figure 25. IR2301 vs. Frequency (IRFPE50),
 $R_{gate}=10\Omega$, $V_{CC}=15V$

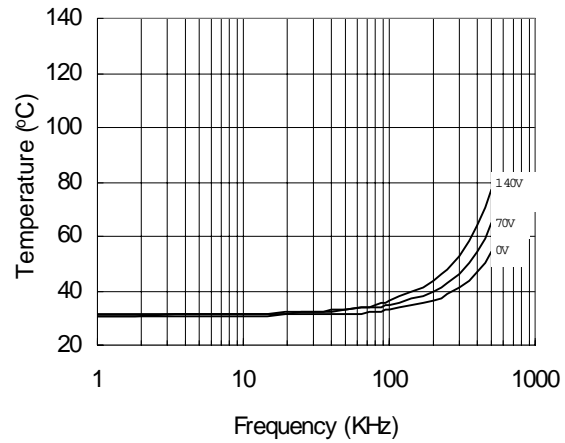

Figure 26. IR2301S vs. Frequency (IRFBC20),
 $R_{gate}=33\Omega$, $V_{CC}=15V$

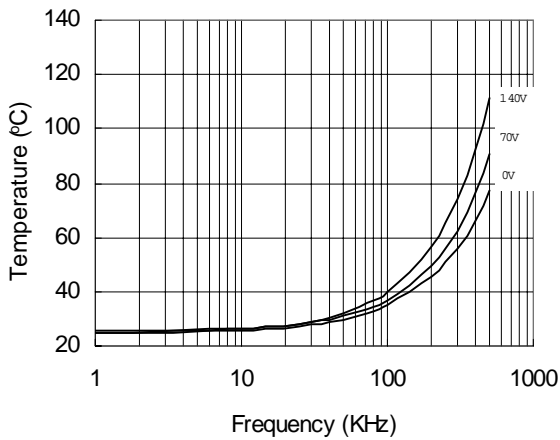

Figure 27. IR2301S vs. Frequency (IRFBC30),
 $R_{gate}=22\Omega$, $V_{CC}=15V$

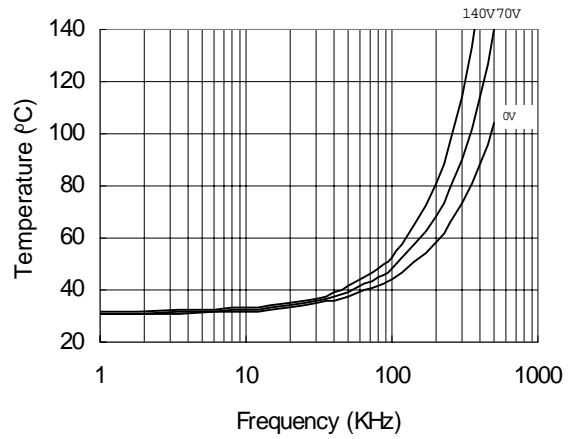

Figure 28. IR2301S vs. Frequency (IRFBC40),
 $R_{gate}=15\Omega$, $V_{CC}=15V$

IR2301(S) & (PbF)

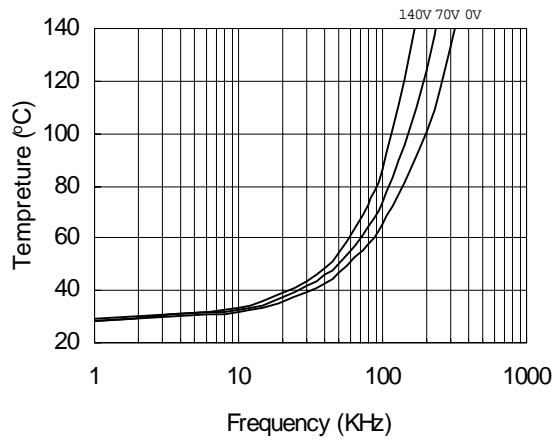
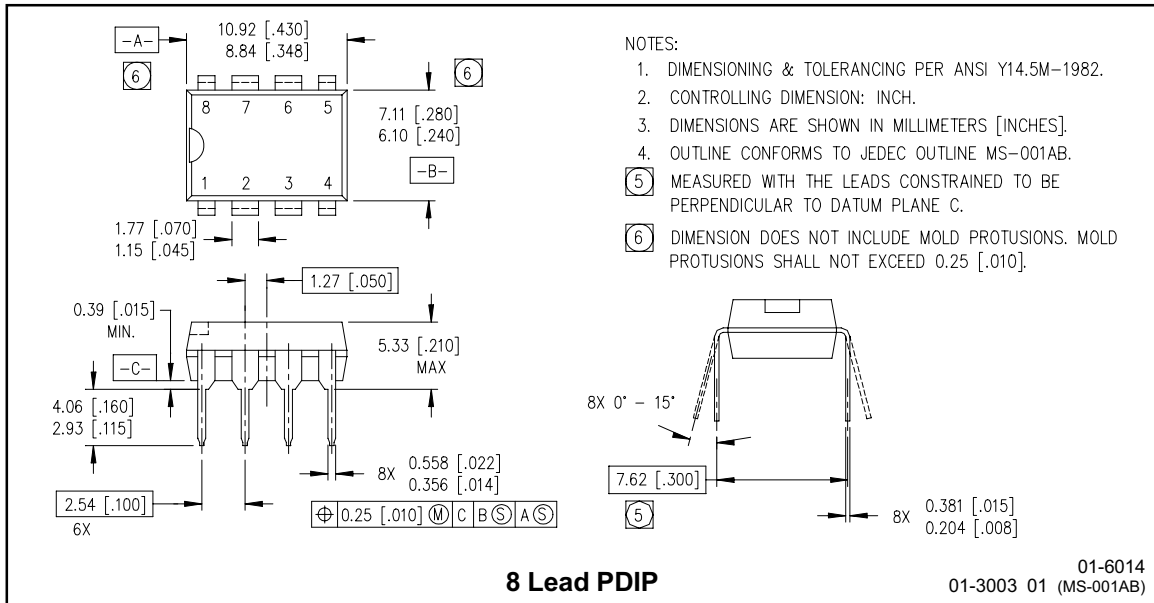
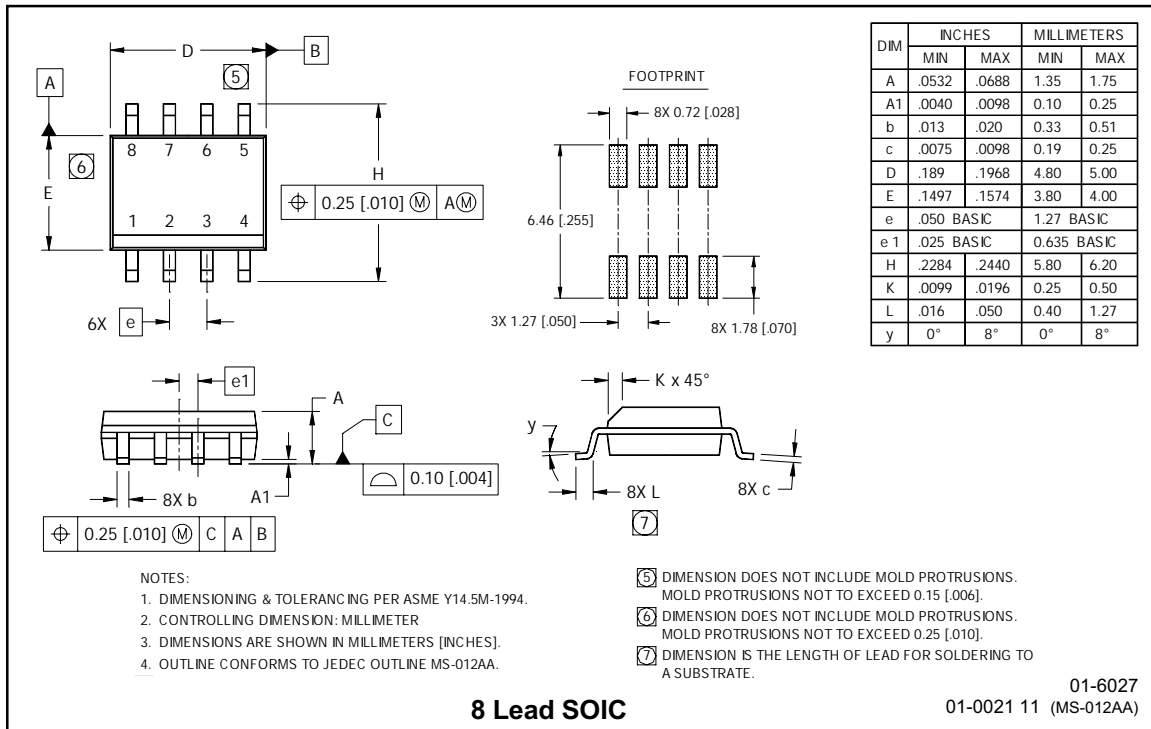

Figure 29. IR2301S vs. Frequency
(IRFPE50), $R_{gate}=10\Omega$, $V_{CC}=15V$

Case Outlines



IR2301(S) & (PbF)



IR2301(S) & (PbF)

LEADFREE PART MARKING INFORMATION

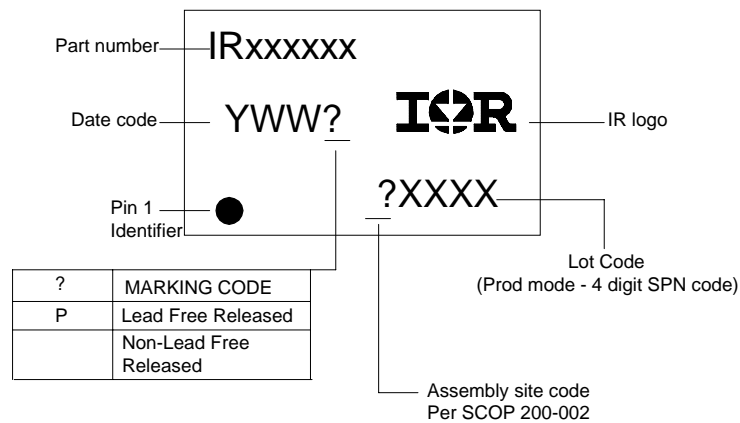

ORDER INFORMATION

Basic Part (Non-Lead Free)

8-Lead PDIP IR2301 order IR2301
8-Lead SOIC IR2301S order IR2301S

Leadfree Part

8-Lead PDIP R2301 order IR2301PbF
8-Lead SOIC IR2301S order IR2301SPbF

单击下面可查看定价，库存，交付和生命周期等信息

[>>Infineon Technologies\(英飞凌\)](#)