

极低噪声系数，应用于全球导航卫星系统的低噪声放大器

特性

- 采用专利的智能线性度增强技术 (SLT) 以减轻射频环境干扰；
- 极低的噪声系数：0.60dB；
- 高功率增益：18.5dB；
- 高线性度 IIP3oob：+4.5dBm；
- 高输入 1dB 压缩点：-9.2dBm；
- 简单的 PCB 应用，只需一个外置的匹配电感；
- 输出内部匹配到 50 欧姆；
- 工作电压：1.5V~3.6V；
- 工作频率：1550~1615MHz；
- 纤小的 1.1mmX0.9mmX 0.45mm DFN 6L 封装
- 3kV HBM 静电保护(包括 RFIN 和 RFOUT 引脚)

应用

- 手机、平板电脑、数码相机
- 个人导航设备、射频前端模组
- 完整的 GPS 芯片模组
- 防盗保护设备

描述

AW5015 是一款适用于 GPS 格洛纳斯，伽利略和北斗等全球导航卫星系统(GNSS) 的低噪声放大器。在射频端口内置隔直电容，所以输入端口无需另加电容，芯片可以尽量靠近天线，减少了线路损耗。其外围元器件简单，只需要一个外置输入匹配电感，节省占板面积，是一款经济高效的解决方案。

AW5015 采用专利的智能线性度增强技术 (SLT)，具有极低噪声系数，高线性度，高增益等特性，可支持低至 1.5V，高至 3.6V 的供电电压。所有这些特性使得 AW5015 成为 GNSS 低噪声放大器的最佳选择，极低的噪声系数大大地改善了灵敏度，高线性度使得系统能更好地抵抗带外干扰，并且降低了前级的滤波要求，进而降低了 GNSS 接收机的总成本。

AW5015 采用纤小的 1.1mm x 0.9 mm x 0.45 mm DFN-6L 封装，额定的工作温度范围为-40°C至 85°C。

引脚分布及标记图



图 1. AW5015 引脚分布及标识图

Ultra-Low Noise Amplifier for Global Navigation Satellite Systems (GNSS)

FEATURES

- Reduce RF environment Interference with patented Smart-Linearity-Technology (SLT);
- Ultra low noise figure(NF)=0.60dB;
- High power gain=18.5dB;
- High linearity IIP3oob=+4.5dBm;
- High input 1dB-compression point=-9.2dBm;
- Requires only one input matching inductor;
- RF output internally matched to 50 ohm;
- Supply voltage: 1.5V to 3.6V;
- Operating frequencies: 1550~1615MHz;
- Slim DFN-6L package:1.1mmX0.9mmX 0.45mm
- 3kV HBM ESD protection (including RFIN and RFOUT pin)

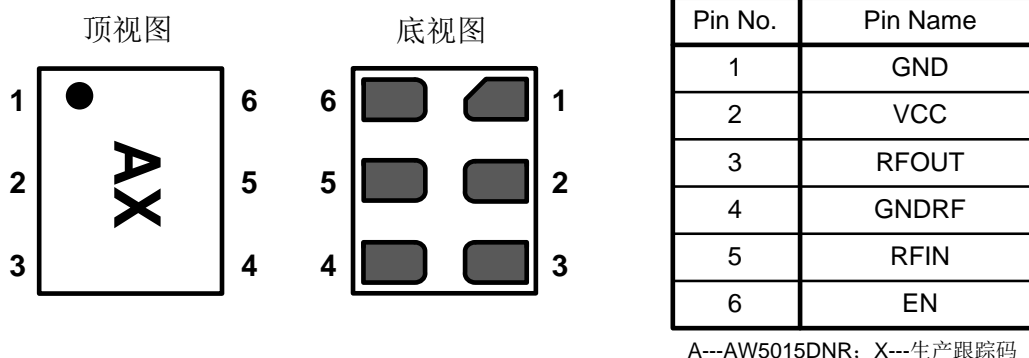
APPLICATIONS

- Smart phones, feature phones,
- Tablet PCs,
- Personal Navigation Devices,
- Digital Still Cameras, Digital Video Cameras;
- RF Front End modules;
- Complete GPS chipset modules;
- Theft protection(laptop, ATM);

INTRODUCTION

The AW5015 is a Low Noise Amplifier designed for Global Navigation Satellite Systems (GNSS) as GPS, GLONASS, Galileo and Compass. With on-chip DC blocking capacitors at RFIN and RFOUT, The AW5015 can be close to the antenna, requires only one external input matching inductor, and reduces assembly complexity and the PCB area, enabling a cost-effective solution.

The AW5015 with patented Smart Linearity Technology (SLT) achieves ultra low noise figure, high linearity, high gain, over a wide range of supply voltages from 1.5V up to 3.6V. All these features make AW5015 an excellent choice for GNSS LNA as it improves sensitivity with low noise figure and high gain, provide better immunity against out-of-band jammer signals with high linearity, reduces filtering requirement of preceding stage and hence reduces the overall cost of the GNSS receiver.

The AW5015 is available in a small lead-free, RoHS-Compliant, 1.1mm x 0.9mm x 0.45mm 6-pin DFN package.

PIN CONFIGURATION AND MARKING

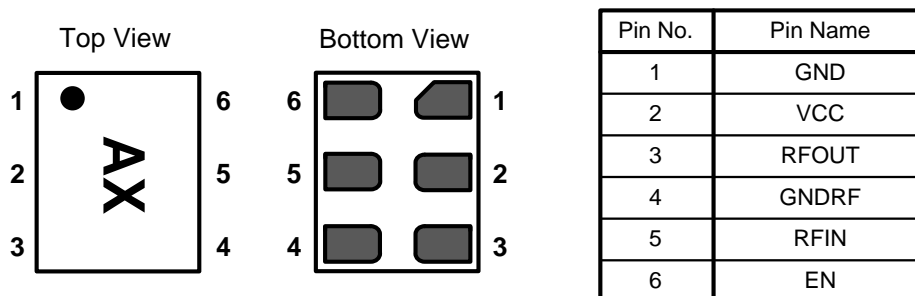

A---AW5015DNR; X---Manufactory trace No.

Figure 1. AW5015 Pin Configuration and Marking

TYPICAL APPLICATION

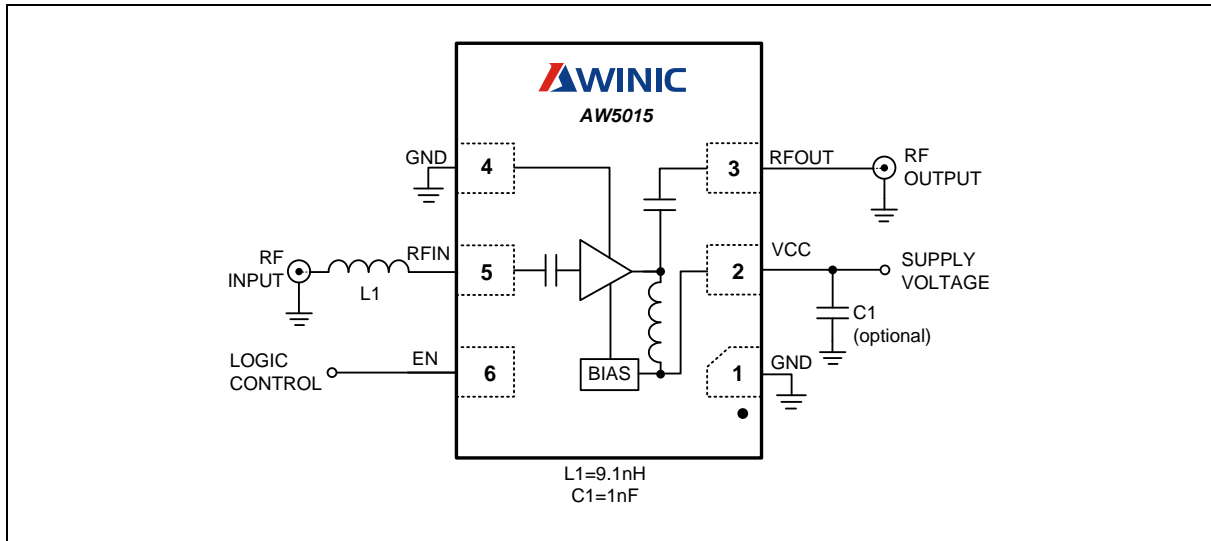

Figure 2. Application Schematic AW5015

For a list of components see [Table 6](#) and [Table 7](#).

ORDER INFORMATION

Table 1. Order Information

Part Number	Temperature	Package	RoHS	Mark	SPQ
AW5015DNR	-40°C ~ 85°C	1.1mm x 0.9 mm x 0.45mm DFN-6L	Yes	A	Tape and Reel 3000pcs/Reel

AW5015 □ □ □
 R : Tape&Reel
 DN: DFN

ABSOLUTE MAXIMUM RATINGS ¹⁾

Table 2 . Limiting Values

Parameter	Symbol	Values			Unit
		Min.	Typ.	Max.	
Supply Voltage at pin VCC	V _{CC}	-0.3	-	5.0	V
Voltage at pin EN ²⁾	V _{EN}	-0.3	-	5.0	V
Current into pin VCC	I _{CC}	-	-	30	mA
RF input power ³⁾	P _{IN}	-	-	10	dBm
Package thermal resistance	θ _{JA}	-	148.2		°C/W
Junction temperature	T _J	-	-	150	°C
Storage temperature range	T _{STG}	-65	-	150	°C
Ambient temperature range	T _{amb}	-40	-	85	°C
Solder temperature(10s)		-	260	-	°C
ESD range					
HBM ⁴⁾			±3000		V
Latch-up					
Standard : JEDEC STANDARD NO.78D NOVEMBER 2011			+IT: +400 -IT: -400		mA mA

Note1: Stresses beyond those listed under “absolute maximum ratings” may cause permanent damage to the device. These are stress ratings only and functional operation of the device at these or any other conditions beyond those indicated under “recommended operating conditions” is not implied. Exposure to absolute maximum rated conditions for extended periods may affect device reliability.

Note2: Warning: due to internal ESD diode protection, the applied DC voltage should not exceed 5.0V in order to avoid excess current.

Note3: The RF input and RF output are AC coupled through internal DC blocking capacitor.

Note4: HBM standard: MIL-STD-883H Method 3015.8.

ELECTRICAL CHARACTERISTICS

Table 3 . Electrical Characteristics

(AW5015 EVB¹⁾; $V_{CC}=1.5$ to $3.6V$, $T_A=-40\sim+85^{\circ}C$, $f=1550MHz$ to $1615MHz$; Typical values are at $V_{CC}=2.8V$ and $T_A=+25^{\circ}C$, $f=1575.42MHz$, unless otherwise noted.)

PARAMETER	CONDITIONS	MIN	TYP	MAX	UNITS
DC ELECTRICAL CHARACTERISTICS					
V_{CC}	Supply Voltage	1.5	-	3.6	V
I_{SD}	Shut-Down Current	EN=Low		1.0	μA
I_{CC}	Supply Current	EN=High	6.9	15.0	mA
V_{EN}	Digital Input-Logic High	0.80			V
V_{EN}	Digital Input-Logic Low			0.45	V
AC ELECTRICAL CHARACTERISTICS					
Gp	Power Gain		18.5		dB
RL_{in}	Input Return Loss		7.0		dB
ISL	Reverse Isolation		31.2		dB
RL_{out}	Output Return Loss		12.0		dB
NF	Noise Figure ²⁾	Zs=50 ohm; No jammer	0.60		dB
Kf	Stability factor	f=20MHz...10GHz	1.0		
NF _j	Noise Figure with jammer	Pjam=-20dBm; fjam=850MHz	0.96		dB
		Pjam=-20dBm; fjam= 1850MHz	1.45		dB
		Pjam=-30dBm; fjam=850MHz	0.64		dB
		Pjam=-30dBm; fjam= 1850MHz	0.69		dB
IP _{1dB}	Inband input 1dB-compression point	f=1575.42MHz;	-9.2		dBm
IIP _{3oob}	Out-of-band input 3 rd -order intercept point	f1= 1712.7MHz; f2=1850MHz; Pin=-20dBm	+4.1		dBm
IIP _{3oob}	Out-of-band input 3 rd -order intercept point	f1= 1712.7MHz; f2=1850MHz; Pin=-30dBm	+4.5		dBm
IIP _{2oob}	Out-of-band input 2 rd -order intercept point	f1= 2400MHz; f2=824.6MHz; Pin=-20dBm	+7.7		dBm
IIP _{2oob}	Out-of-band input 2 rd -order intercept point	f1= 2400MHz; f2=824.6MHz; Pin=-30dBm	+7.7		dBm
H2-input referred	LTE band-13 2 nd Harmonic	f=787.76MHz; Pin=-25dBm; f _{H2} =1575.52MHz	-66.1		dBm

Table 3 . Characteristics.....continued

(AW5015 EVB¹⁾; $V_{CC}=1.5$ to $3.6V$, $T_A=-40\sim+85^{\circ}C$, $f=1550MHz$ to $1615MHz$; Typical values are at $V_{CC}=2.8V$ and $T_A=+25^{\circ}C$, $f=1575.42MHz$, unless otherwise noted.)

PARAMETER		CONDITIONS	MIN	TYP	MAX	UNITS
AC ELECTRICAL CHARACTERISTICS						
t_{on}	Turn-on time ³⁾			2.2		μs
t_{off}	Turn-off time ³⁾			1.7		μs

Table 4 . Electrical Characteristics

(AW5015 EVB¹⁾; VCC=1.5 to 3.6V, T_A=-40~+85°C, f=1550MHz to 1615MHz; Typical values are at V_{CC}=1.8V and T_A=+25°C, f=1575.42MHz, unless otherwise noted.)

PARAMETER	CONDITIONS	MIN	TYP	MAX	UNITS
DC ELECTRICAL CHARACTERISTICS					
V _{CC}	Supply Voltage	1.5	-	3.6	V
I _{SD}	Shut-Down Current	EN=Low		1.0	μA
I _{CC}	Supply Current	EN=High	6.2	15.0	mA
V _{EN}	Digital Input-Logic High	0.80			V
V _{EN}	Digital Input-Logic Low			0.45	V
AC ELECTRICAL CHARACTERISTICS					
G _p	Power Gain		18.0		dB
RL _{in}	Input Return Loss		6.5		dB
ISL	Reverse Isolation		31.0		dB
RL _{out}	Output Return Loss		13.5		dB
NF	Noise Figure ²⁾	Z _s =50 ohm; No jammer	0.61		dB
K _f	Stability factor	f=20MHz...10GHz	1.0		
NF _j	Noise Figure with jammer	P _{jam} =-20dBm; f _{jam} =850MHz	1.01		dB
		P _{jam} =-20dBm; f _{jam} =1850MHz	1.49		dB
		P _{jam} =-30dBm; f _{jam} =850MHz	0.67		dB
		P _{jam} =-30dBm; f _{jam} =1850MHz	0.71		dB
IP _{1dB}	Inband input 1dB-compression point	f=1575.42MHz	-14.5		dBm
IIP _{3oob}	Out-of-band input 3 rd -order intercept point	f ₁ =1712.7MHz; f ₂ =1850MHz; Pin=-20dBm;	-2.5		dBm
IIP _{3oob}	Out-of-band input 3 rd -order intercept point	f ₁ =1712.7MHz; f ₂ =1850MHz; Pin=-30dBm;	-0.5		dBm
IIP _{2oob}	Out-of-band input 2 rd -order intercept point	f ₁ =824.6MHz; f ₂ =2400MHz; Pin=-20dBm	+7.1		dBm
IIP _{2oob}	Out-of-band input 2 rd -order intercept point	f ₁ =824.6MHz; f ₂ =2400MHz; Pin=-30dBm	+7.1		dBm
H2-input referred	LTE band-13 2 nd Harmonic	f=787.76MHz; Pin=-25dBm; f _{H2} =1575.52MHz	-65.0		dBm

Table 4 . Characteristics.....continued

(AW5015 EVB¹⁾; VCC=1.5 to 3.6V, TA=-40~+85°C, f=1550MHz to 1615MHz; Typical values are at VCC=1.8V and TA=+25°C, f=1575.42MHz, unless otherwise noted.)

PARAMETER	CONDITIONS	MIN	TYP	MAX	UNITS
AC ELECTRICAL CHARACTERISTICS					
t _{on}	Turn-on time ³⁾		2.2		μs
t _{off}	Turn-off time ³⁾		1.7		μs

Note1: input matched to 50 ohm using a high quality-factor 9.1nH inductor.

Note2: 0.08dB PCB losses are subtracted.

Note3: Within 10% of the final gain.

TYPICAL OPERATING CHARACTERISTICS

(AW5015 EVB; Typical values are at $V_{CC}=2.8V$ and $T_A=+25^\circ C$, $f_{RFIN}=1575.42MHz$, unless otherwise noted.)

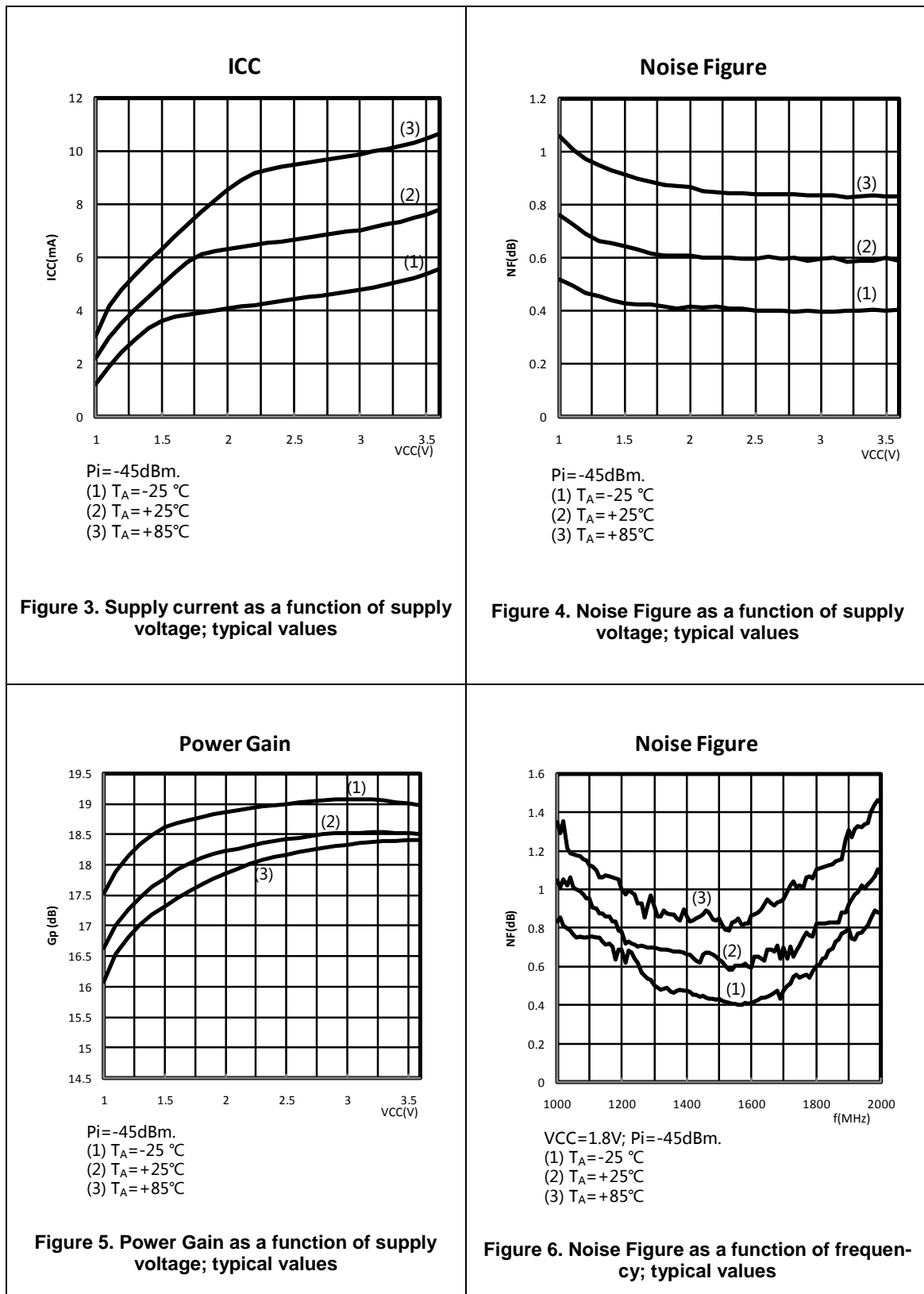

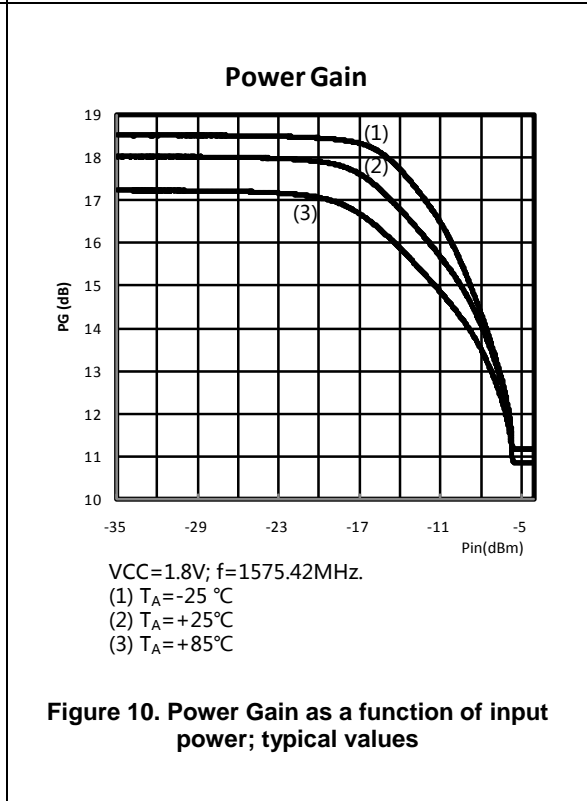
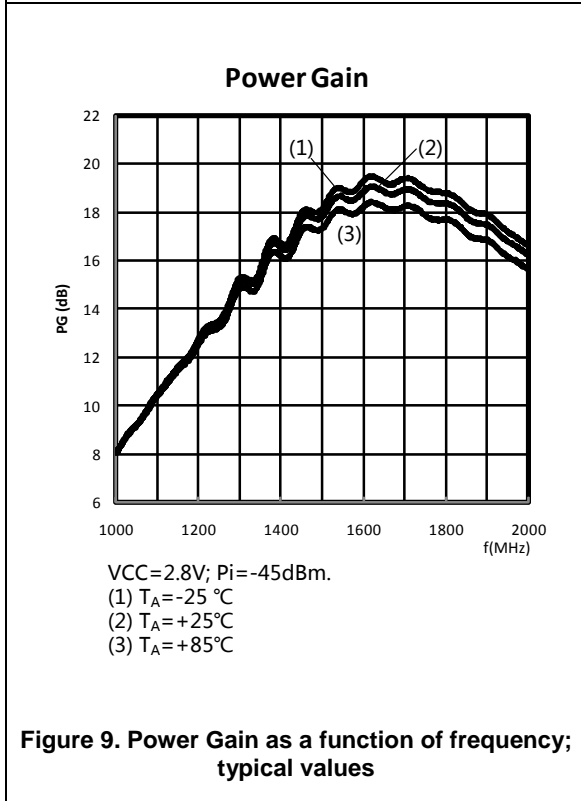
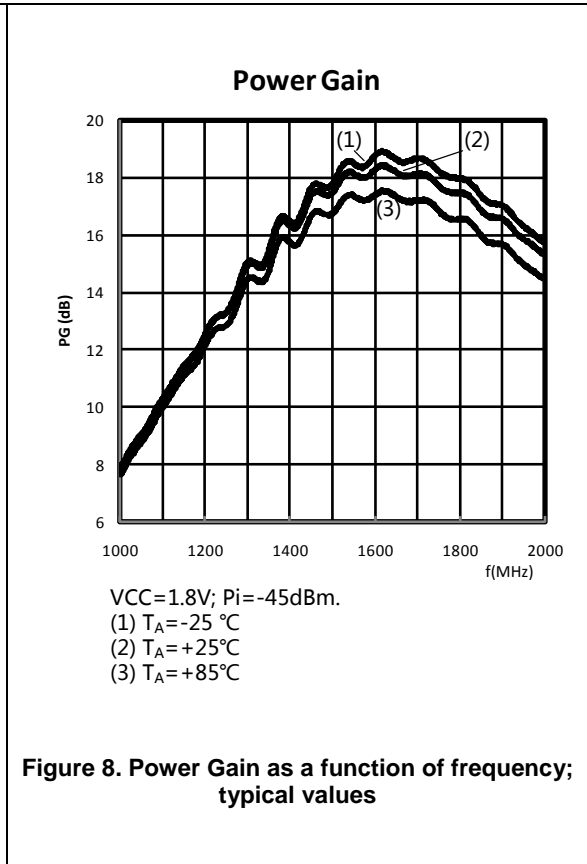
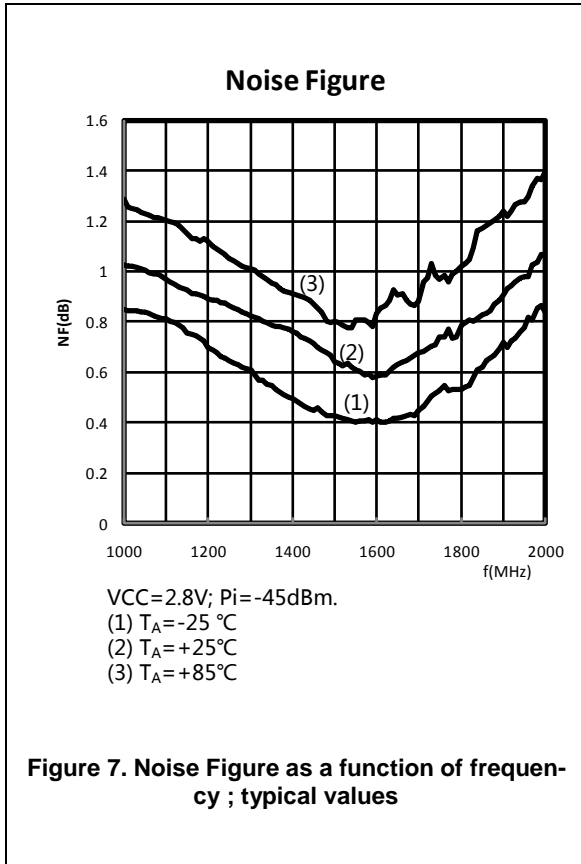

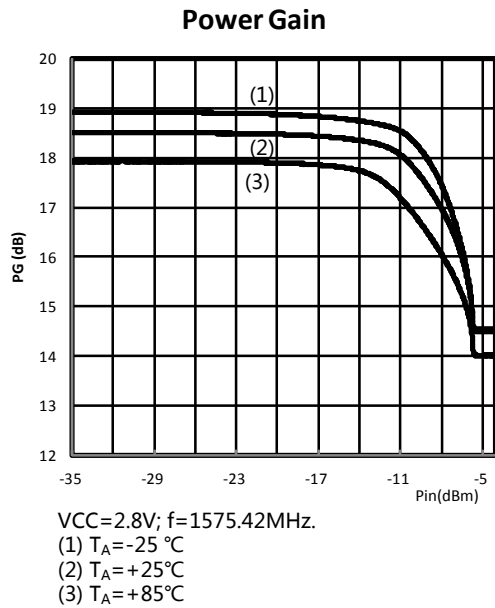

Figure 11. Power Gain as a function of input power; typical values

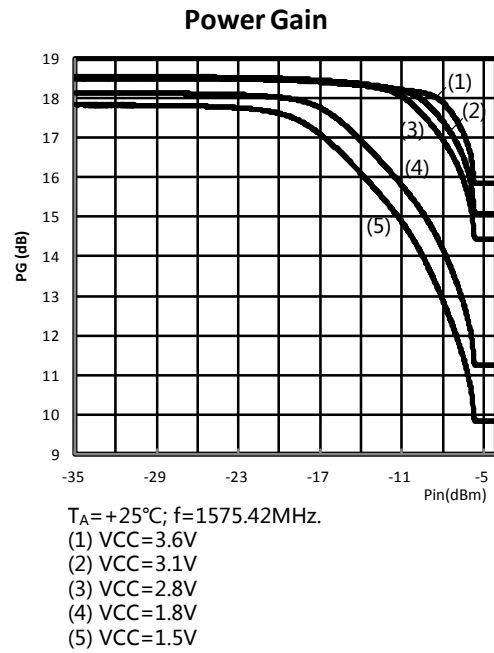

Figure 12. Power Gain as a function of input power; typical values

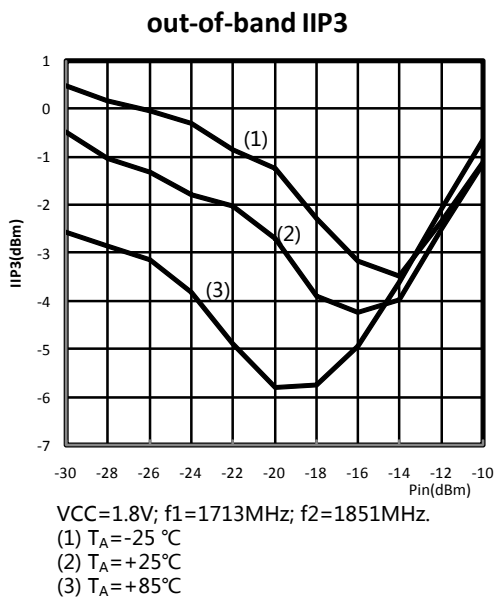

Figure 13. out-of-band input IP3 as a function of input power; typical values

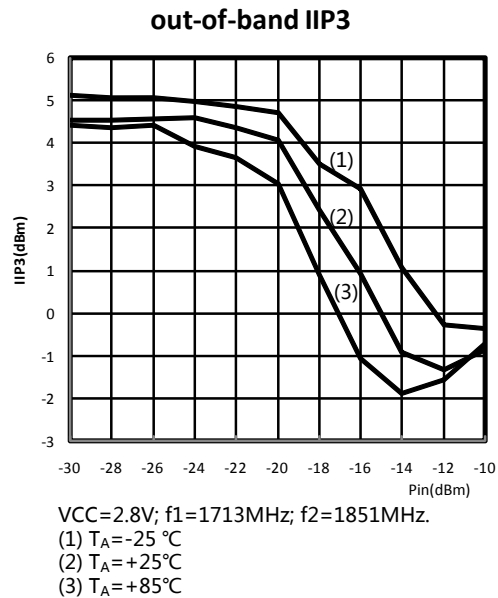
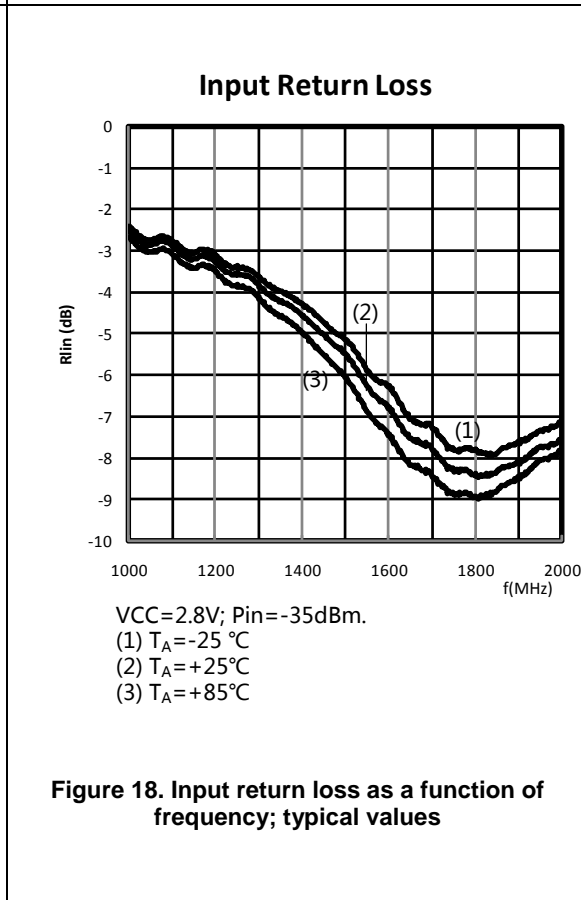
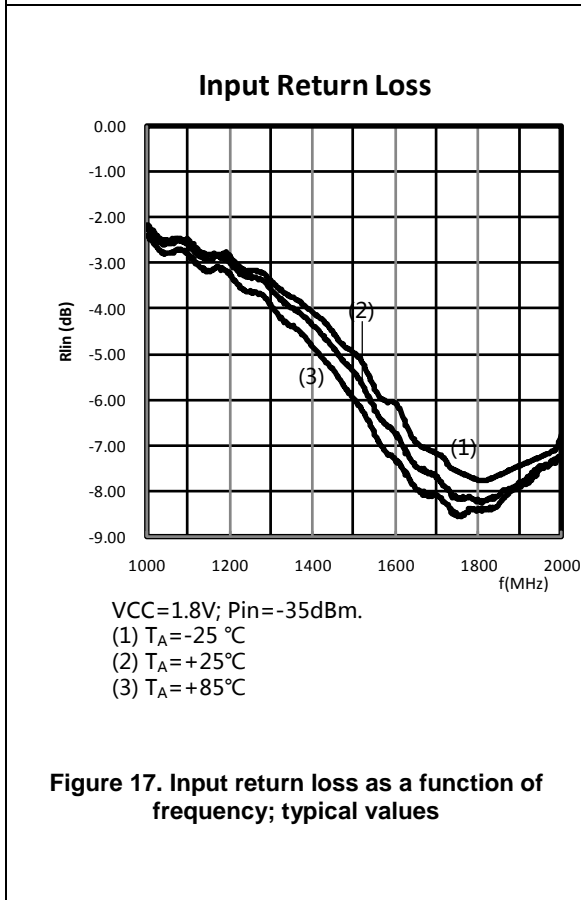
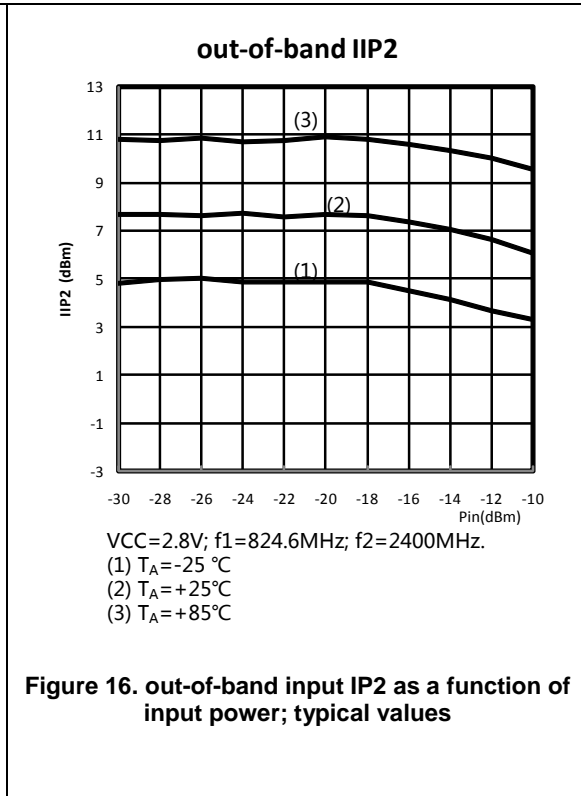
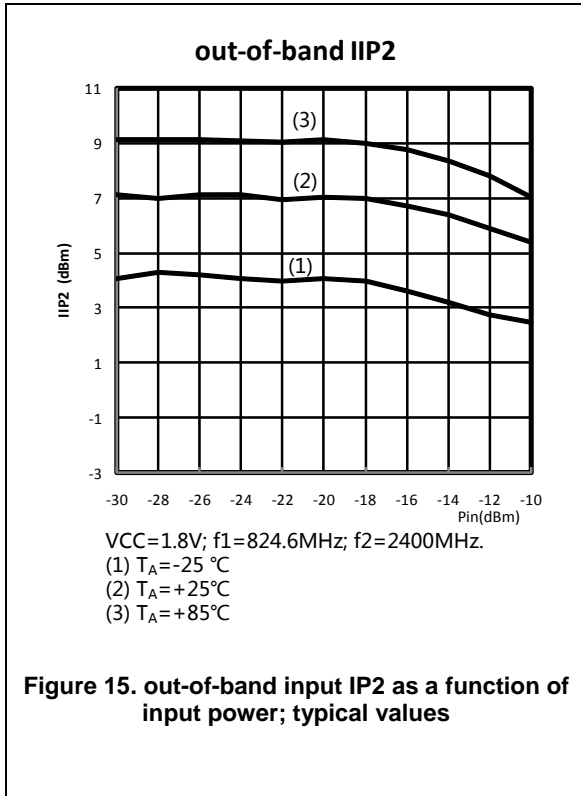
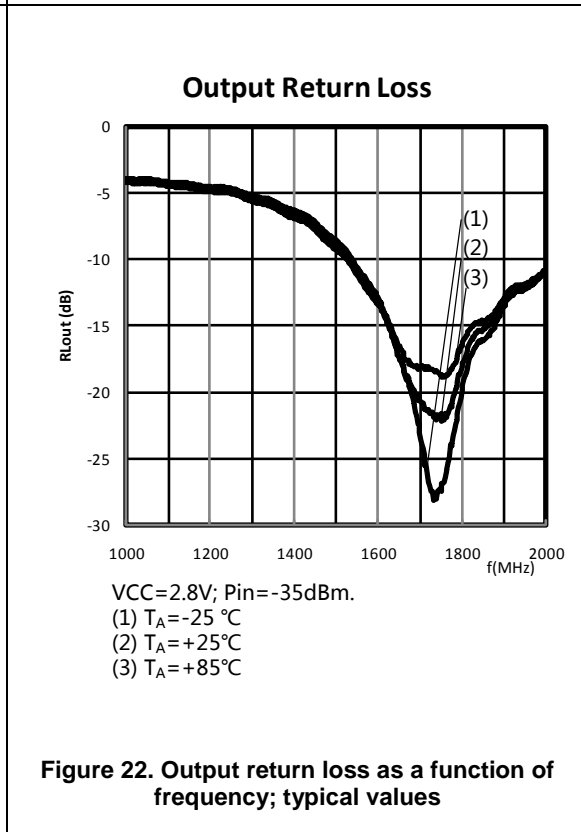
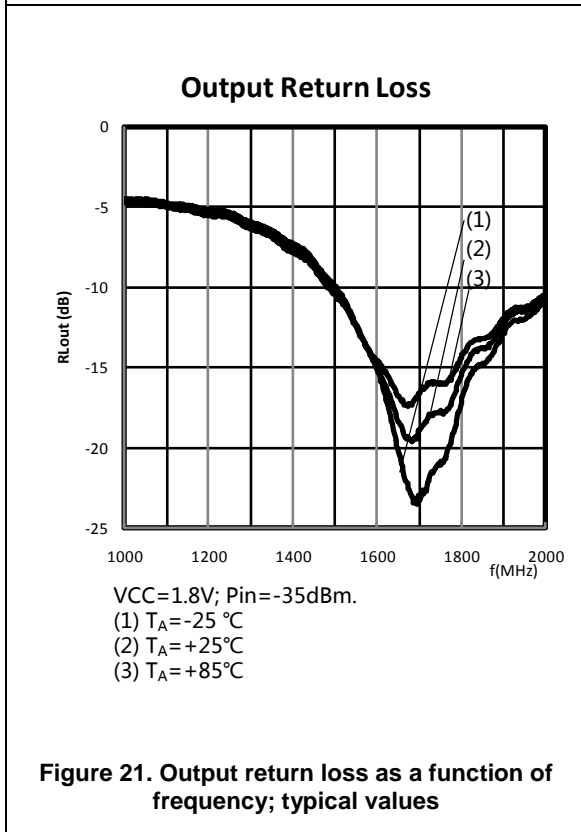
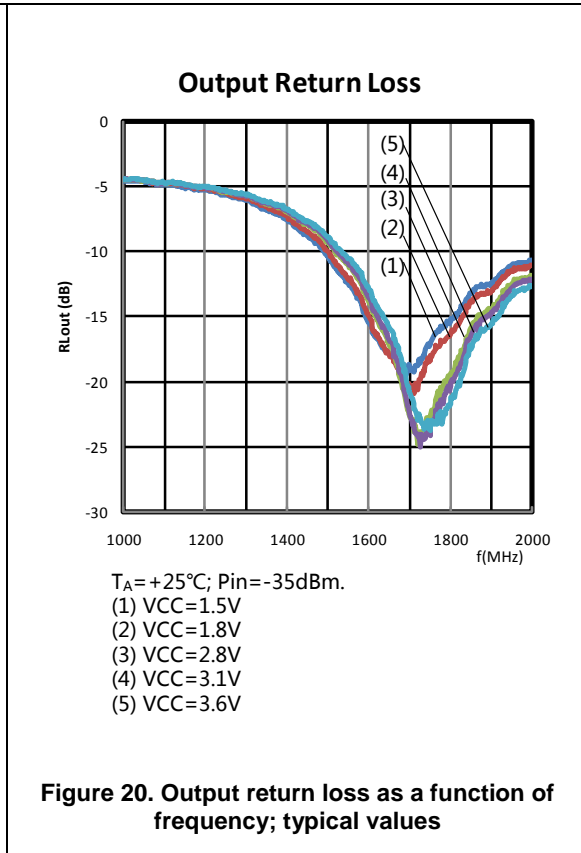
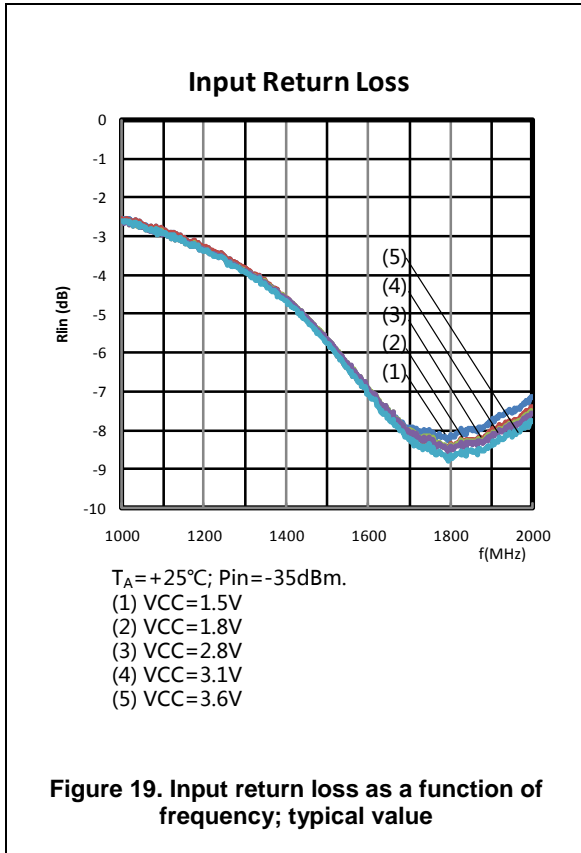
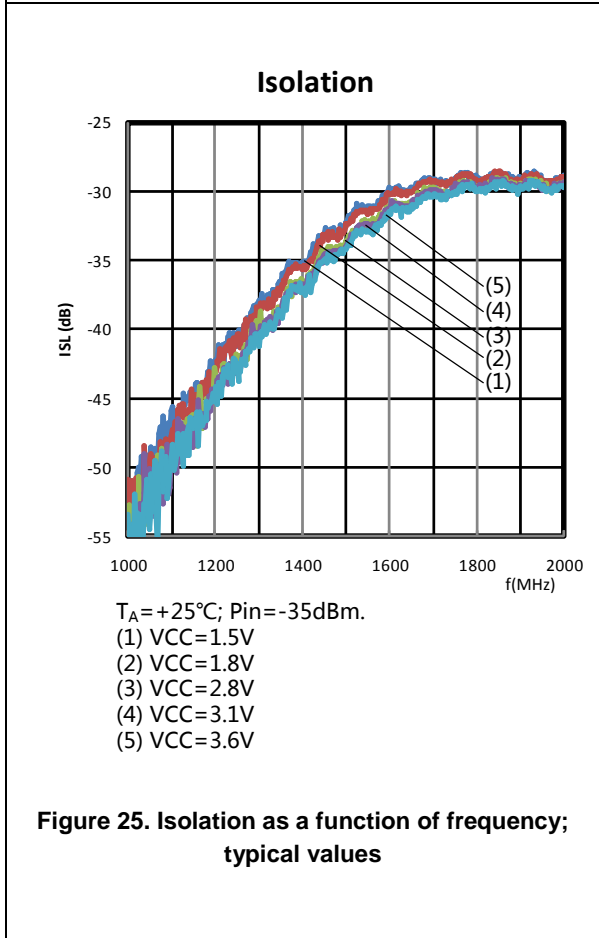
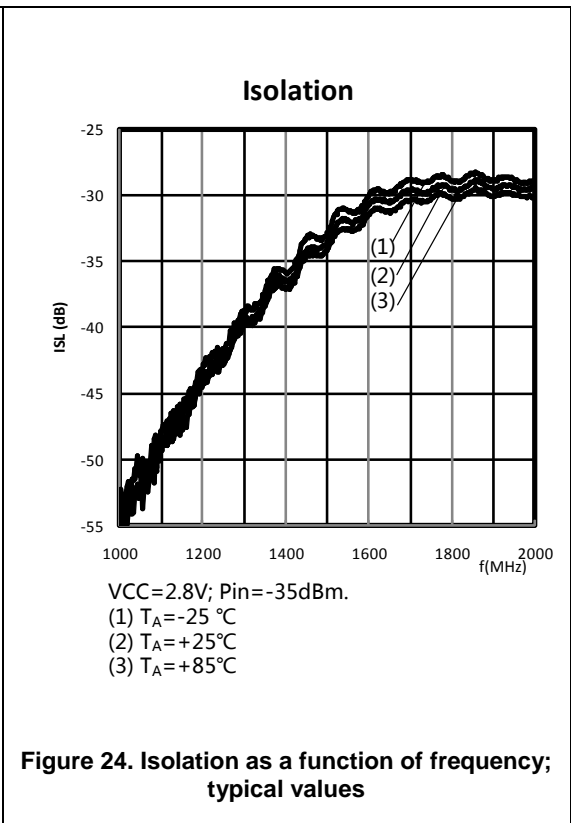
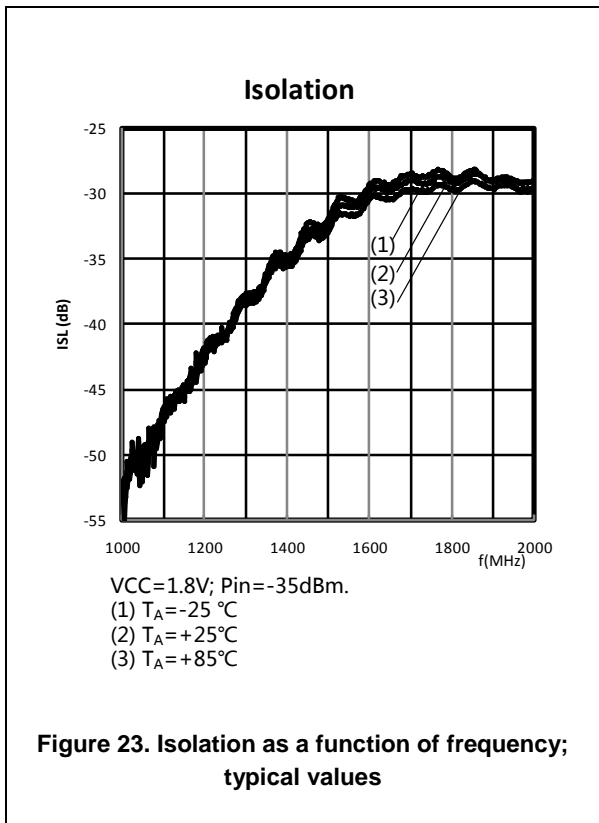

Figure 14. out-of-band input IP3 as a function of input power; typical values







AW5015 APPLICATION BOARD

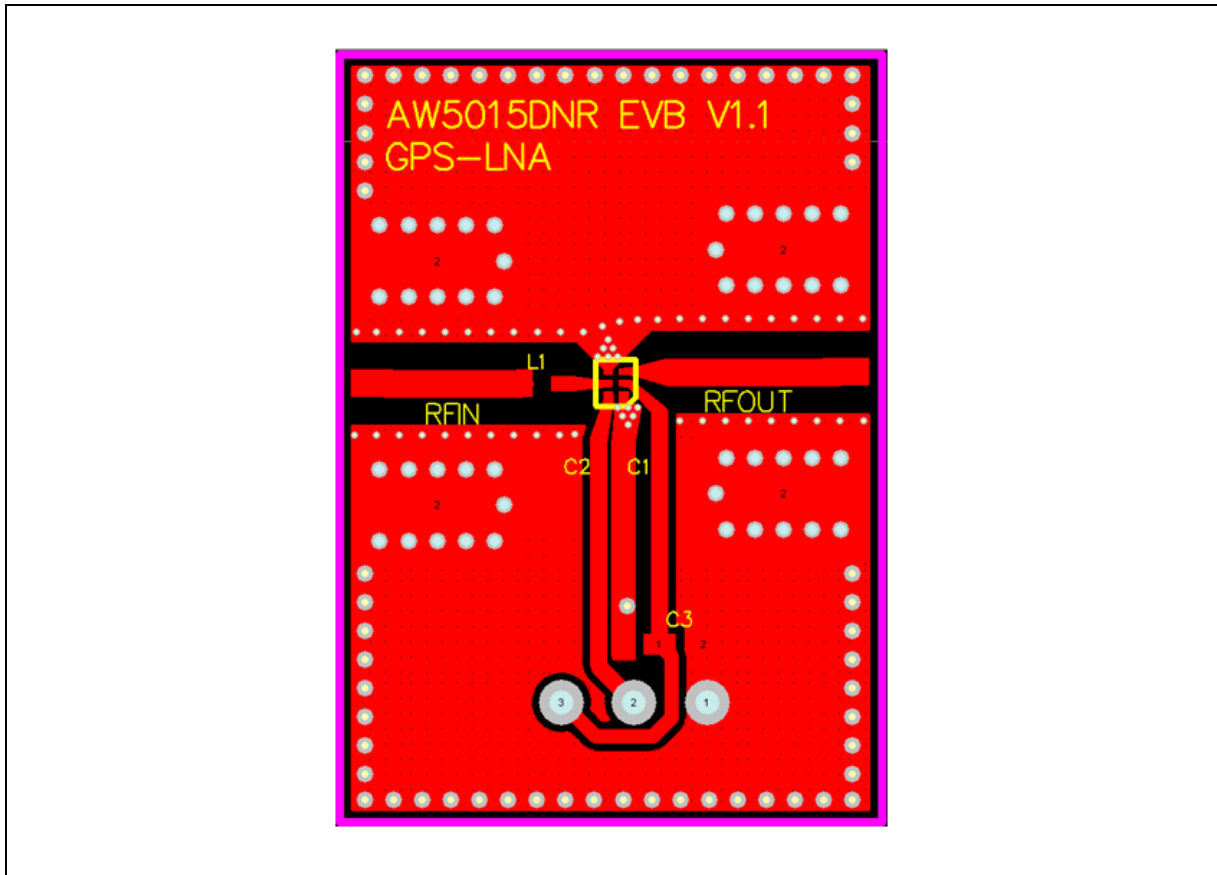

Figure 26. Drawing of Application Board

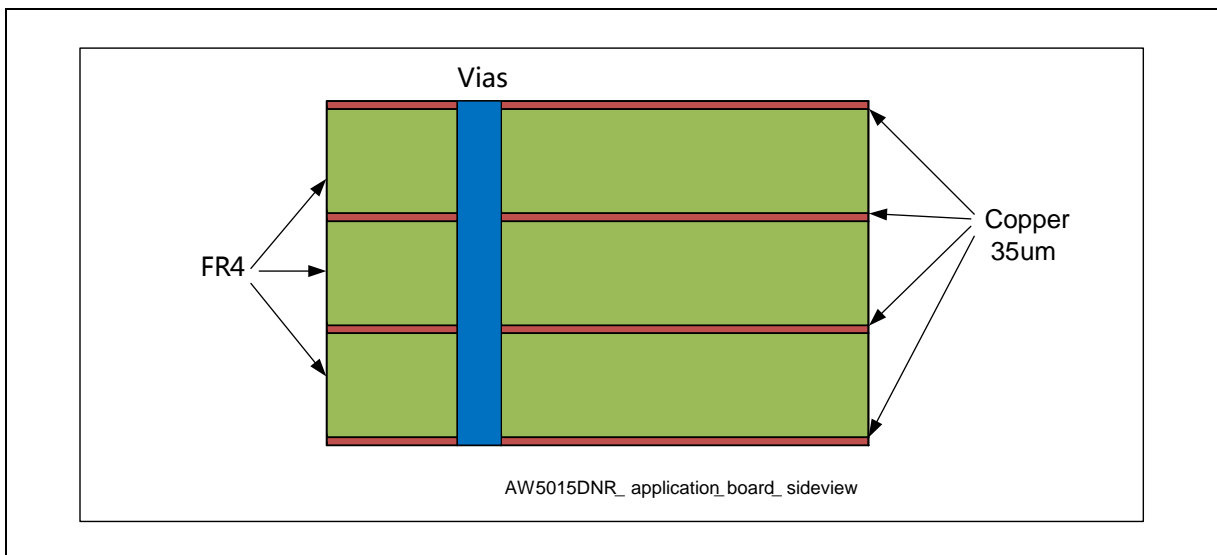

Figure 27. Application Board Cross-Section

TEST CIRCUITS

1. DC Characteristics test: including power supply, pin voltage, supply current, standby current

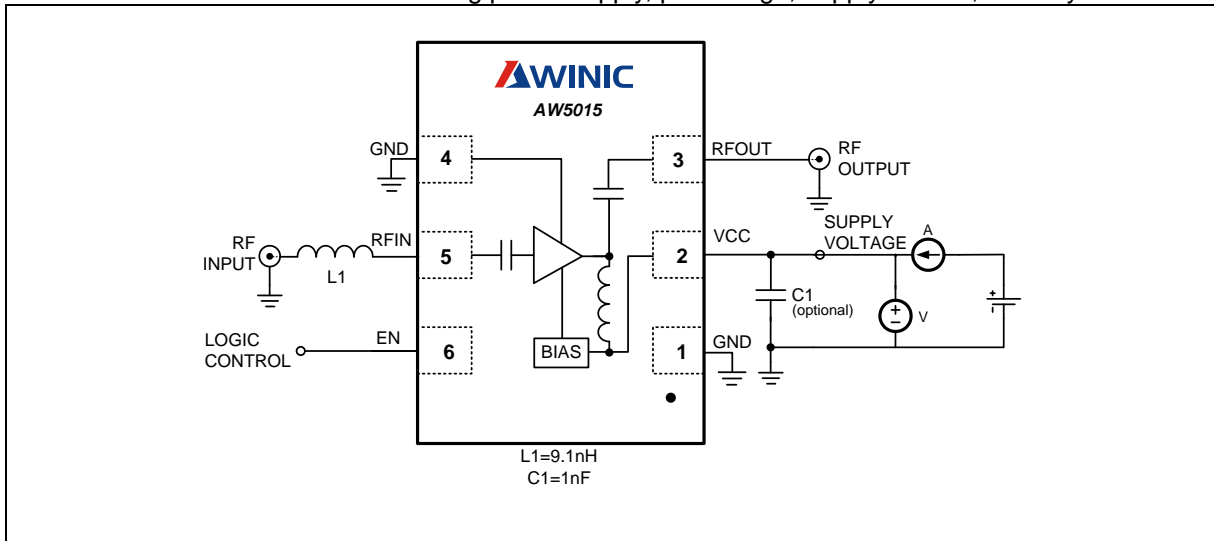

Figure 28. Circuit for DC test

2. S Parameter test: including input return loss, output return loss, reverse isolation, forward gain, 1dB gain compression.

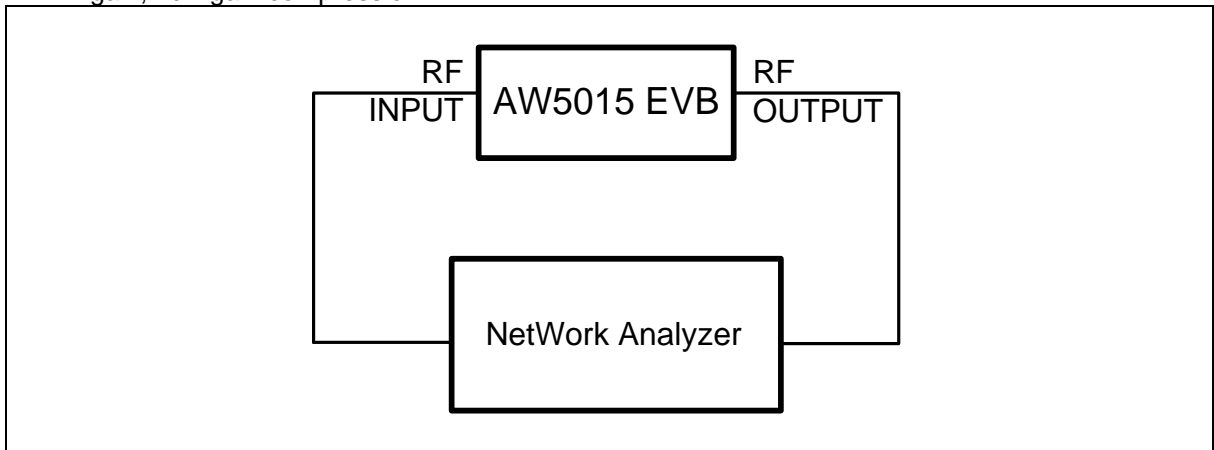

Figure 29. Circuit for S Parameter test

3. Noise Figure test: including noise figure, power gain.

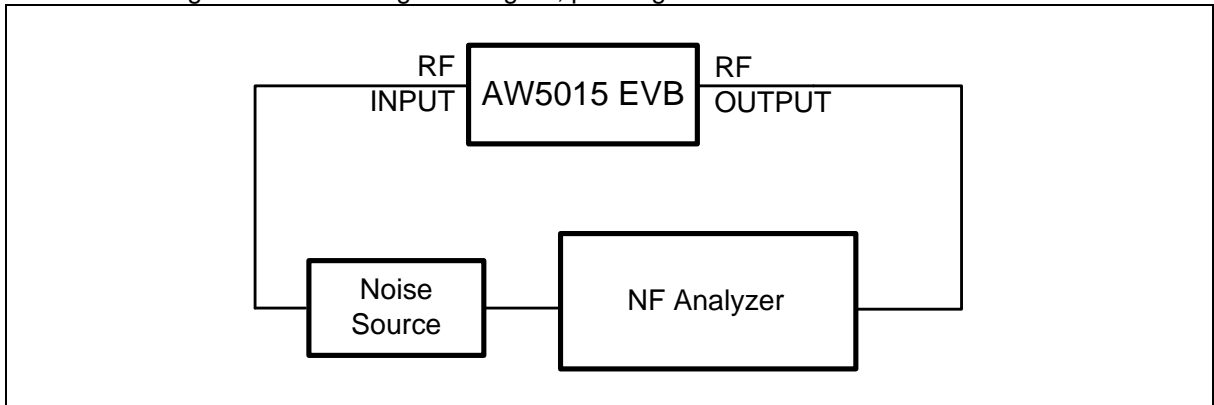

Figure 30. Circuit for Noise Figure test

4. Intermodulation distortion test: including third-order intercept point.

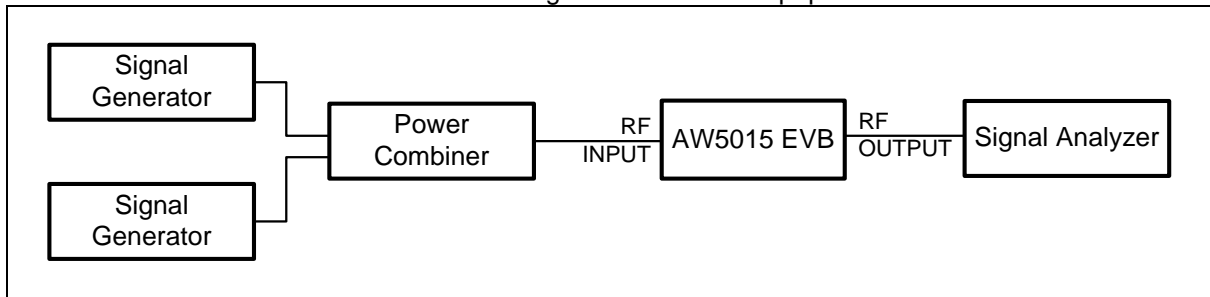

Figure 31. Circuit for intermodulation distortion test

APPLICATION INFORMATIONS

1.1 EN control

The AW5015 includes an internal switch to turn off the entire chip: apply logic high to EN to turn on, and a logic low to shut down.

1.2 List of components

1. The AW5015 requires only one external inductor for input matching. If the device/phone manufacturers implement very good power supply filtering on their boards, the bypass capacitor mentioned in this application circuit may be optional. With the capacitor we can get better performance like a little higher gain etc. The value is optimized for the best gain, noise figure, return loss performance. Typical value of inductor is 9.1nH, capacitor is 1nF. For schematics see [Figure2](#).

2. The output of AW5015 is internally matched to 50 ohm and a DC blocking capacitor is integrated on-chip, thus no external component is required at the output.
3. The AW5015 should be placed close to the GPS antenna with the input-matching inductor. Use 50-ohm microstrip lines to connect RF INPUT and RF OUTPUT. Bypass capacitor should be located close to the device. For long Vcc lines, it may be necessary to add more decoupling capacitors. Proper grounding of the GND pins is very important.

Table6 lists the recommended inductor types and values; Table 7 lists the recommended capacitor types and values.

Table6: list of inductor

Part Number	Inductance	Q(min)	Q Test Frequency	Supplier	Size
Units	nH		MHz		
LQW15A	9.1	25	250	Murata	0402
SDWL1005C	9.1	24	250	Sunlord	0402

Table7: list of capacitor

Part Number	Capacitance	Rated Voltage	Supplier	Size
Units	pF	V		
GRM155	1000	50	Murata	0402

PACKAGE INFORMATION

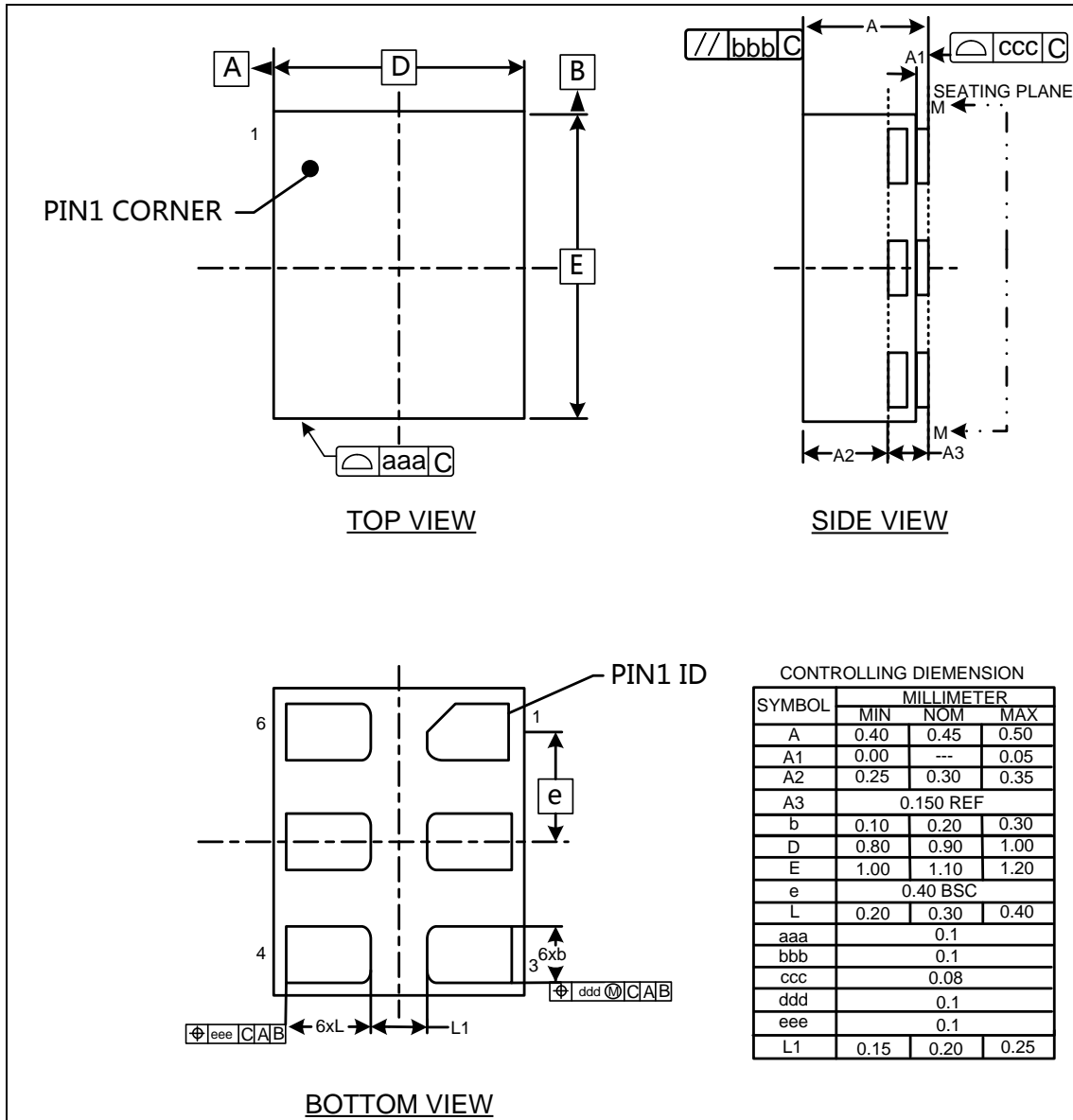
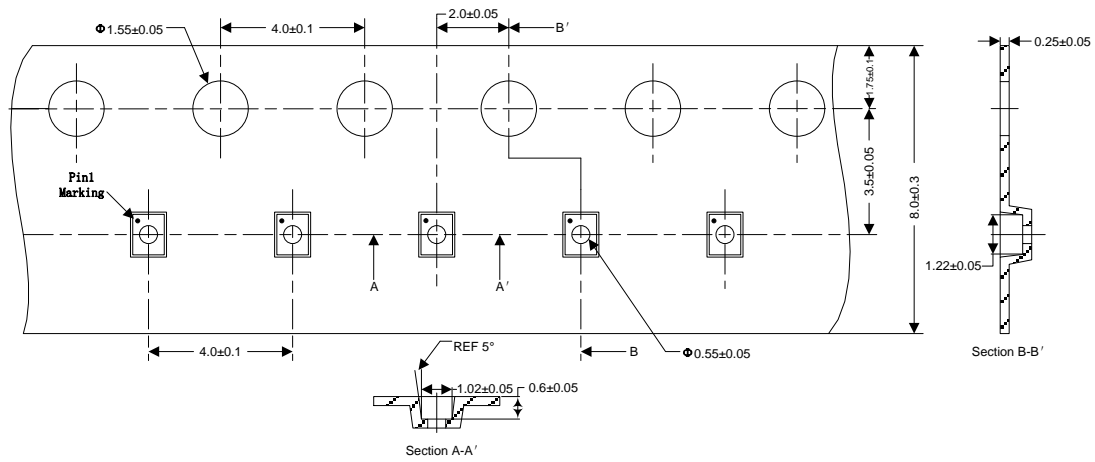

Figure 32. Package Outline

TAPE&REEL DESCRIPTION



NOTES:

- 1.10 procket hole pitch cumulative tolerance ± 0.2
- 2.The meander of the tape is assumed with 1mm or less every 100mm between 250mm
- 3.MATERIAL:CONDUCTIVE POYSTYRENE
- 4.ALL DIMS IN MM
- 5.There must not be foreign body adhesion and the state of the surface must be excellent
- 6.17" PAPER-Reel, 125000 pockets(500m)
- 7.Surface resistance $1 \times 10^{11}(\max)$ OHMS/SQ

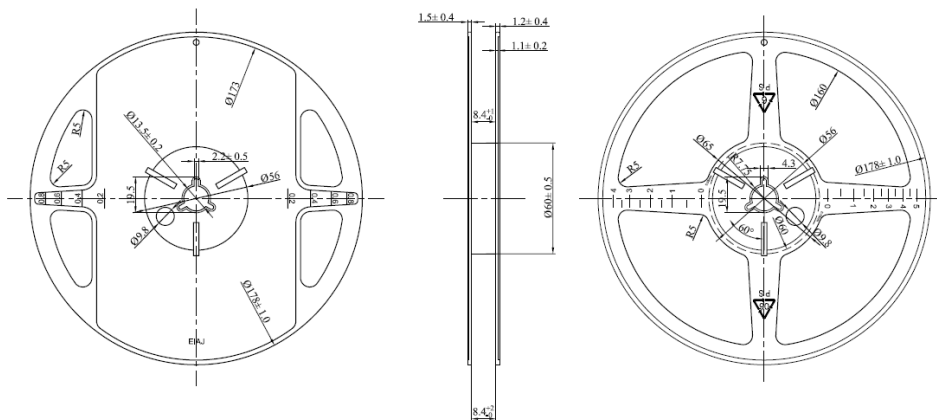

注意：

1. 材料：聚苯乙烯（黑色）；
2. 平整度：最大允许3毫米；
3. 所有尺寸为毫米；
4. 表面电阻： $10E5 \sim 10E11$ OHMS/SQ以下
5. 所有未注公差： ± 0.25 。

Figure 33. Tape & Reel

REFLOW

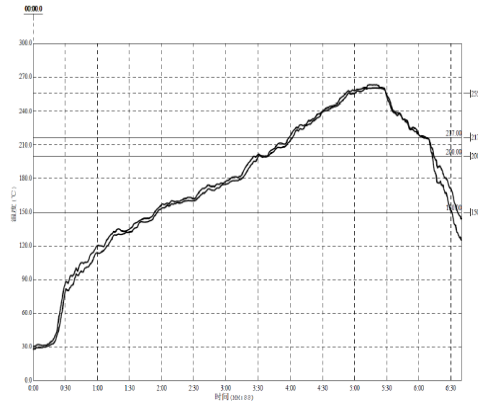

Figure 24 Package Reflow Oven Thermal Profile

Reflow Note	Spec
Average ramp-up rate (217°C to Peak)	Max. 3°C/sec
Time of Preheat temp. (from 150°C to 200°C)	60-120sec
Time to be maintained above 217°C	60-150sec
Peak Temperature	>260°C
Time within 5°C of actual peak temp	20-40sec.
Ramp-down rate	Max. 6°C/sec
Time from 25°C to peak temp	Max. 8min.

FOOTPRINT INFORMATION

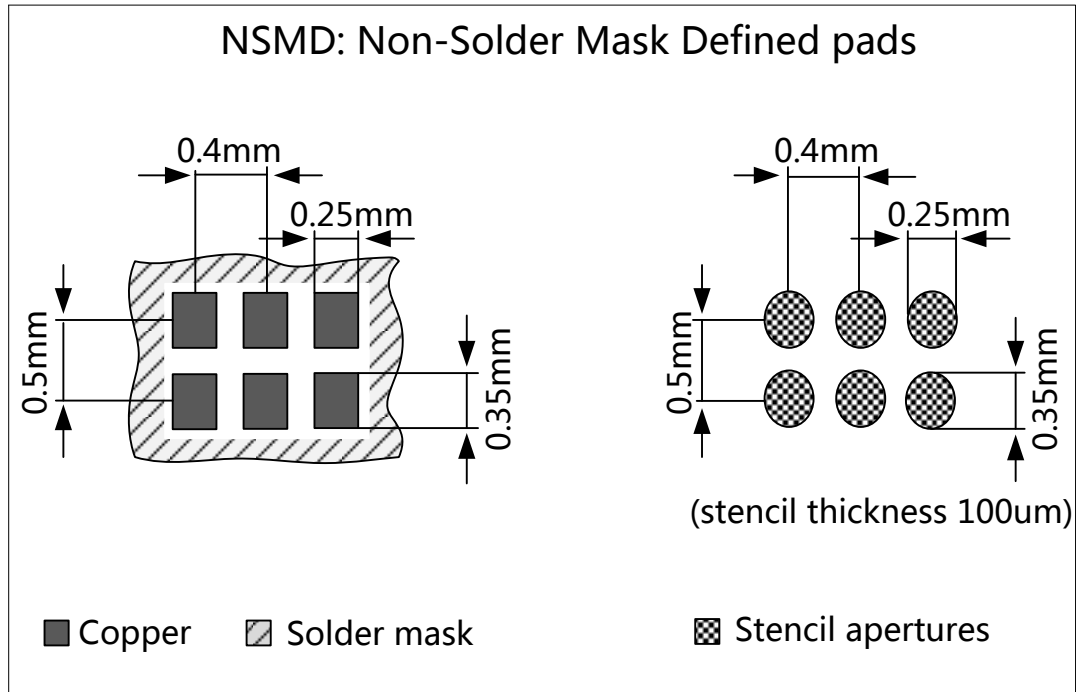

Figure 34. Footprint

REVISION HISTORY

Table 8. Revision history

Document ID	Release date	Change notice	Supersedes
AW5015_V1.2	2016-04	Added REFLOW NOTES	AW5015_V1.1
AW5015_V1.1	2015-12	Added Tape & Reel Description and corrected the marking location of Pin1	AW5015_V1.0
AW5015_V1.0	2014-04	Product data sheet <ul style="list-style-type: none"> • Updated typical operating characteristics with temperature variation • Added ESD characteristics • Added IIP2oob • Added Jammed noise figure • Added footprint information • Added revision history 	AW5015_V0.8
AW5015_V0.8	2014-02	Preliminary data sheet <ul style="list-style-type: none"> • Updated electrical characteristics • Updated typical operating characteristics under $T_A=+25^{\circ}\text{C}$ 	AW5015_V0.7
AW5015_V0.7	2013-11	Preliminary data sheet	-

Notice: Shanghai Awinic Technology Co. Ltd cannot assume responsibility for use of any circuitry other than circuitry entirely embodied in an Awinic product. No circuit patent licenses are implied. Awinic reserves the right to change the circuitry and specifications without notice at any time.

单击下面可查看定价，库存，交付和生命周期等信息

[>>AWINIC\(艾为\)](#)