

General Description

These N-Channel enhancement mode power field effect transistors are using trench DMOS technology. This advanced technology has been especially tailored to minimize on-state resistance, provide superior switching performance, and withstand high energy pulse in the avalanche and commutation mode. These devices are well suited for high efficiency fast switching applications.

BVDSS	R _{DS(ON)}	I _D
60V	6mΩ	100A

TO220 Pin Configuration

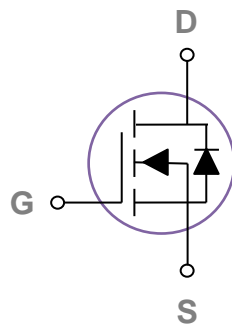

Features

- 60V, 100A, R_{DS(ON)} = 6mΩ @V_{GS} = 10V
- Improved dv/dt capability
- Fast switching
- 100% EAS Guaranteed
- Green Device Available

AI

- Motor Drive
- Power Tools
- LED Lighting
- Quick Charger

Absolute Maximum Ratings T_c=25°C unless otherwise noted

Symbol	Parameter	Rating	Units
V _{DS}	Drain-Source Voltage	60	V
V _{GS}	Gate-Source Voltage	±20	V
I _D	Drain Current – Continuous (T _c =25°C)	100	A
	Drain Current – Continuous (T _c =100°C)	63.2	A
I _{DM}	Drain Current – Pulsed ¹	400	A
EAS	Single Pulse Avalanche Energy ²	181	mJ
IAS	Single Pulse Avalanche Current ²	60.1	A
P _D	Power Dissipation (T _c =25°C)	169	W
	Power Dissipation – Derate above 25°C	1.35	W/°C
T _{STG}	Storage Temperature Range	-55 to 150	°C
T _J	Operating Junction Temperature Range	-55 to 150	°C

Thermal Characteristics

Symbol	Parameter	Typ.	Max.	Unit
R _{θJA}	Thermal Resistance Junction to ambient	---	62	°C/W
R _{θJC}	Thermal Resistance Junction to Case	---	0.74	°C/W

Electrical Characteristics (T_J=25 °C, unless otherwise noted)
Off Characteristics

Symbol	Parameter	Conditions	Min.	Typ.	Max.	Unit
BV _{DSS}	Drain-Source Breakdown Voltage	V _{GS} =0V, I _D =250uA	60	---	---	V
ΔBV _{DSS} /ΔT _J	BV _{DSS} Temperature Coefficient	Reference to 25°C, I _D =1mA	---	0.036	---	V/°C
I _{DSS}	Drain-Source Leakage Current	V _{DS} =60V, V _{GS} =0V, T _J =25°C	---	---	1	uA
		V _{DS} =48V, V _{GS} =0V, T _J =125°C	---	---	10	uA
I _{GSS}	Gate-Source Leakage Current	V _{GS} =±20V, V _{DS} =0V	---	---	±100	nA

On Characteristics

R _{DS(ON)}	Static Drain-Source On-Resistance ³	V _{GS} =10V, I _D =20A	---	5.1	6	mΩ
		V _{GS} =4.5V, I _D =10A	---	5.9	7.5	mΩ
V _{GS(th)}	Gate Threshold Voltage	V _{GS} =V _{DS} , I _D =250uA	1.2	1.6	2.5	V
ΔV _{GS(th)}	V _{GS(th)} Temperature Coefficient		---	-5.08	---	mV/°C
g _{fs}	Forward Transconductance	V _{DS} =10V, I _D =3A	---	15	---	S

Dynamic and switching Characteristics

Q _g	Total Gate Charge ^{3, 4}	V _{DS} =30V, V _{GS} =4.5V, I _D =10A	---	32.8	65	nC
Q _{gs}	Gate-Source Charge ^{3, 4}		---	10.8	20	
Q _{gd}	Gate-Drain Charge ^{3, 4}		---	11.6	22	
T _{d(on)}	Turn-On Delay Time ^{3, 4}	V _{DD} =15V, V _{GS} =10V, R _G =3.3Ω I _D =1A	---	20	40	ns
T _r	Rise Time ^{3, 4}		---	14.2	28	
T _{d(off)}	Turn-Off Delay Time ^{3, 4}		---	61.2	122	
T _f	Fall Time ^{3, 4}		---	16.8	34	
C _{iss}	Input Capacitance	V _{DS} =25V, V _{GS} =0V, F=1MHz	---	4740	7110	pF
C _{oss}	Output Capacitance		---	325	488	
C _{rss}	Reverse Transfer Capacitance		---	161	332	
R _g	Gate resistance		V _{GS} =0V, V _{DS} =0V, F=1MHz	---	1.6	

Drain-Source Diode Characteristics and Maximum Ratings

Symbol	Parameter	Conditions	Min.	Typ.	Max.	Unit
I _S	Continuous Source Current	V _G =V _D =0V, Force Current	---	---	100	A
I _{SM}	Pulsed Source Current ³		---	---	200	A
V _{SD}	Diode Forward Voltage ³	V _{GS} =0V, I _S =1A, T _J =25°C	---	---	1	V

Note :

1. Repetitive Rating : Pulsed width limited by maximum junction temperature.
2. V_{DD}=25V, V_{GS}=10V, L=0.1mH, I_{AS}=60.1A., R_G=25Ω, Starting T_J=25°C.
3. The data tested by pulsed, pulse width ≤ 300us, duty cycle ≤ 2%.
4. Essentially independent of operating temperature.

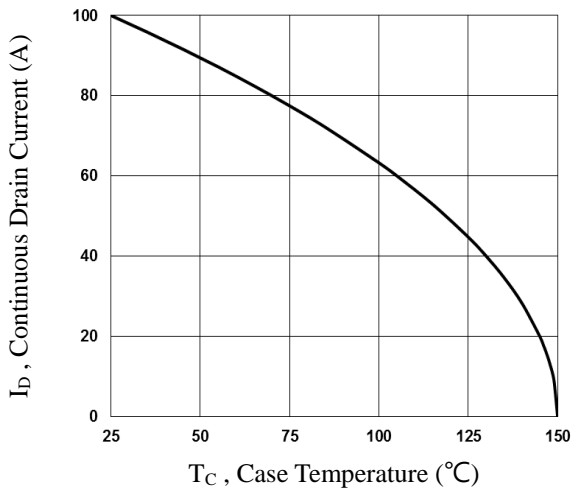

Fig.1 Continuous Drain Current vs. T_c

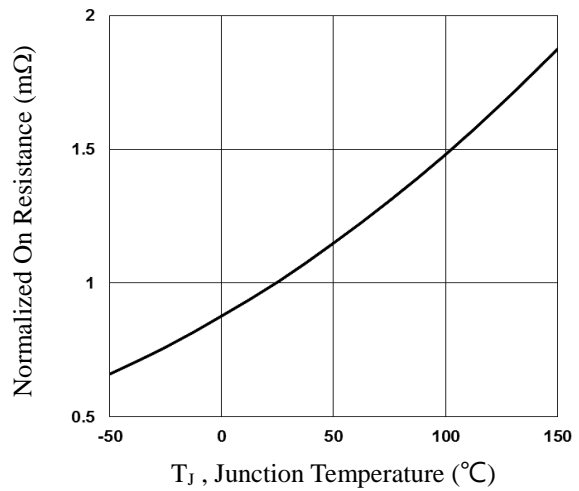

Fig.2 Normalized R_{DS(on)} vs. T_j

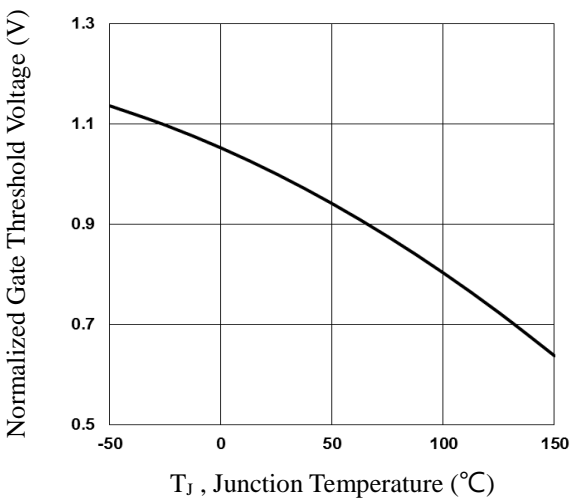

Fig.3 Normalized V_{th} vs. T_j

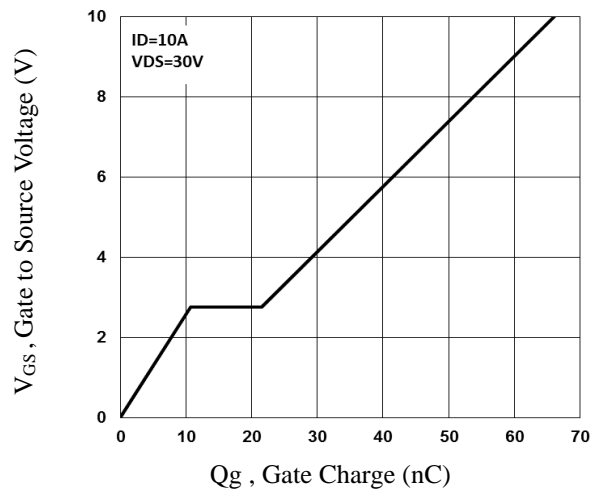

Fig.4 Gate Charge Waveform

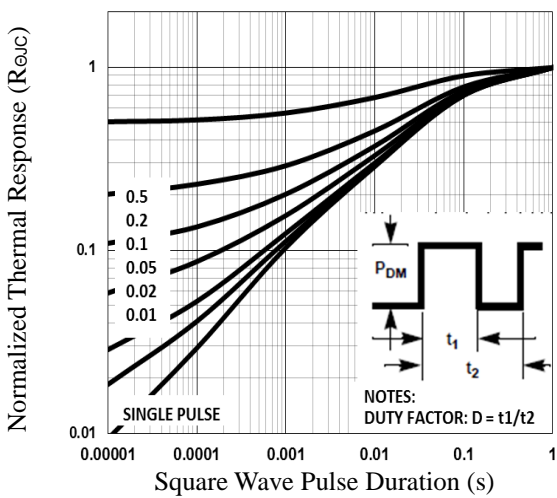

Fig.5 Normalized Transient Response

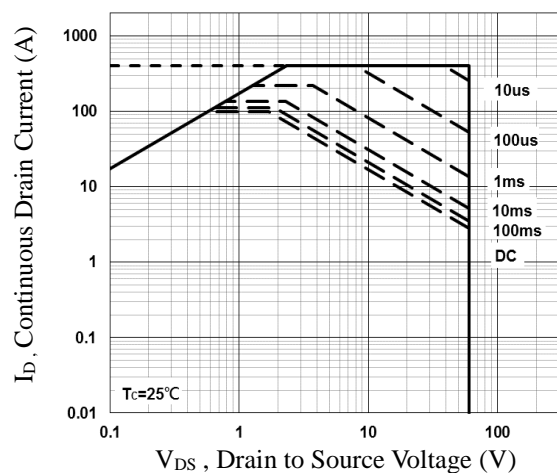

Fig.6 Maximum Safe Operation Area

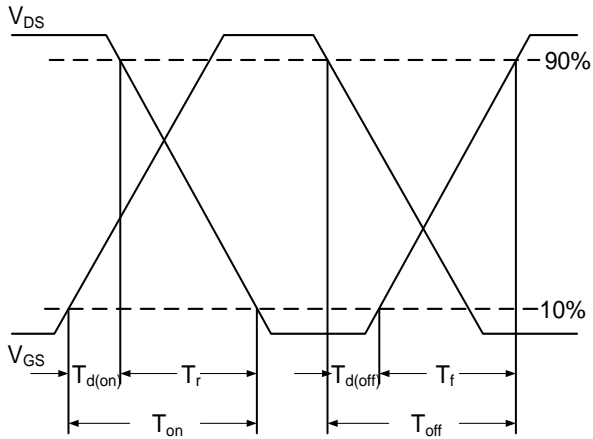

Fig.7 Switching Time Waveform

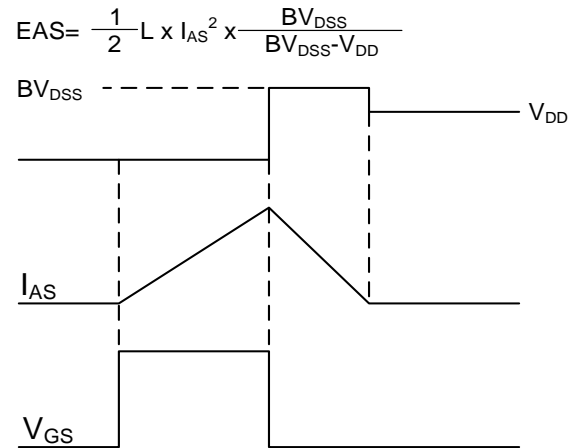
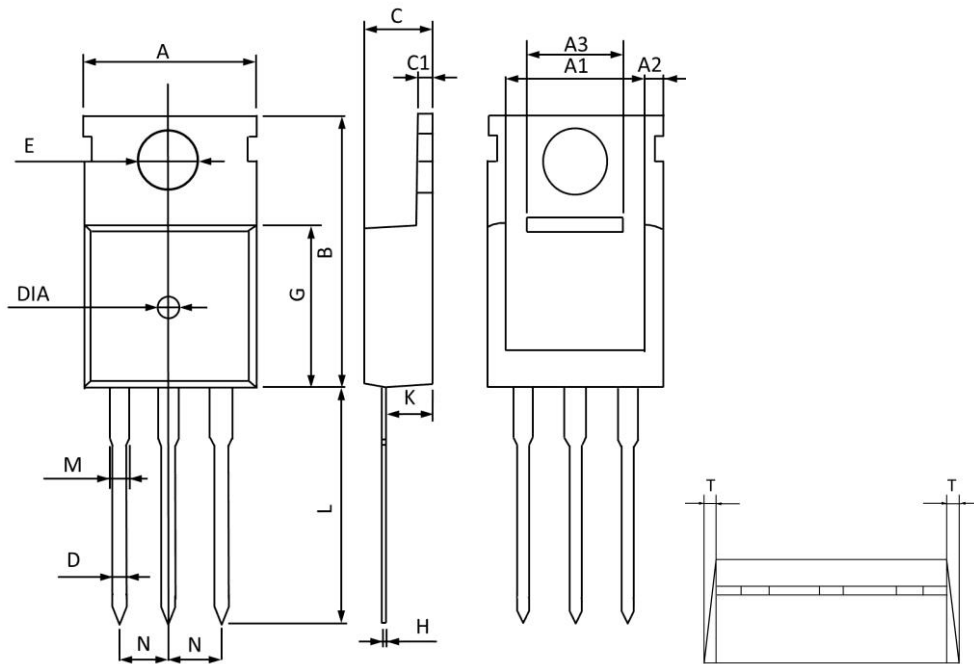

Fig.8 EAS Waveform

TO220 PACKAGE INFORMATION



Symbol	Dimensions In Millimeters		Dimensions In Inches	
	MAX	MIN	MAX	MIN
A	10.300	9.700	0.406	0.382
A1	8.840	8.440	0.348	0.332
A2	1.250	1.050	0.049	0.041
A3	5.300	5.100	0.209	0.201
B	16.200	15.400	0.638	0.606
C	4.680	4.280	0.184	0.169
C1	1.500	1.100	0.059	0.043
D	1.000	0.600	0.039	0.024
E	3.800	3.400	0.150	0.134
G	9.300	8.700	0.366	0.343
H	0.600	0.400	0.024	0.016
K	2.700	2.100	0.106	0.083
L	13.600	12.800	0.535	0.504
M	1.500	1.100	0.059	0.043
N	2.590	2.490	0.102	0.098
T	W0.35		W0.014	
DIA	Φ1.5 TYP.	deep0.2 TYP.	Φ0.059 TYP.	deep0.008 TYP.

单击下面可查看定价，库存，交付和生命周期等信息

[>>Potens\(博盛\)](#)