

## General Description

The PVI Series Photovoltaic Isolator generates an electrically isolated DC voltage upon receipt of a DC input signal. It is capable of directly driving gates of power MOSFETs or IGBTs. It utilizes a monolithic integrated circuit photovoltaic generator of novel construction as its output. The output is controlled by radiation from a GaAlAs light emitting diode (LED), which is optically isolated from the photovoltaic generator.

The PVI Series is ideally suited for applications requiring high-current and/or high-voltage switching with optical isolation between the low-level driving circuitry and high-energy or high-voltage load circuits. It can be used for directly driving gates of power MOSFETs. The dual-channel device allows its outputs to drive independent discrete power MOSFETs, or be connected in parallel or in series to provide higher current drive for power MOSFETs or higher voltage drive for IGBTs. The PVI Series Photovoltaic isolators employ fast turn-off circuitry.

These PVI Series Photovoltaic Isolators are packaged in 8-pin, molded DIP packages and available with either thru-hole or surface-mount ("gull-wing") leads, in plastic shipping tubes.

## Features

- Isolated Voltage Source
- Monolithic Construction
- Up to 5 $\mu$ A Output
- Single or Dual Output
- Solid-State Reliability

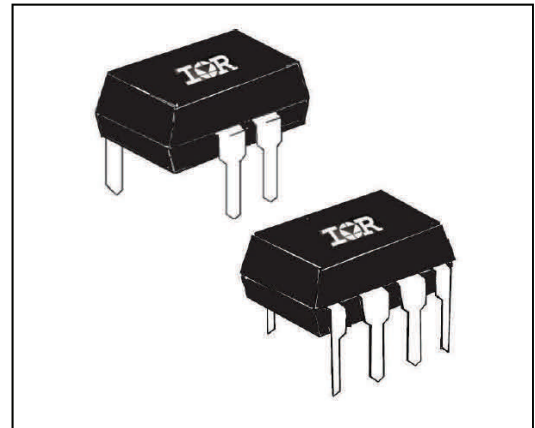

## Applications

- Load Distribution
- Industrial Controls
- Current-to-Voltage Conversion
- Custom Solid-State Relay

## Part Identification

PVI1050NPbF	thru-hole
PVI5050NPbF	thru-hole
PVI1050NSPbF	Surface-mount (gull-wing)
PVI5050NSPbF	Surface-mount (gull-wing)
PVI1050NS-TPbF	Surface-mount, tape and reel

**Electrical Specifications** ( $-40^{\circ}\text{C} \leq T_A \leq +85^{\circ}\text{C}$  unless otherwise specified)

<b>INPUT CHARACTERISTICS</b>	<b>Limits</b>	<b>Units</b>
Input Current Range (see figure 4)	2.0 to 50	mA <sub>(DC)</sub>
Maximum Forward Voltage Drop @ 10mA, 25°C (see figure 5)	1.4	V <sub>(DC)</sub>
Maximum Reverse Voltage	6.0	V <sub>(DC)</sub>
Maximum Reverse Current @ -6.0V (DC), 25°C	100	μA <sub>(DC)</sub>
Maximum Pulsed Input Current @ 25°C (see figure 6)	1.0	A <sub>(peak)</sub>

<b>OUTPUT CHARACTERISTICS</b>	<b>Limits</b>	<b>Units</b>
Maximum Forward Voltage @ 10μA	8.0 per channel	V <sub>(DC)</sub>
Maximum Reverse Current @ -10V <sub>DC</sub>	10	μA <sub>(DC)</sub>

<b>COUPLED CHARACTERISTICS</b>	<b>Limits PVI5050N</b>	<b>Limits PVI1050N</b>	<b>Units</b>
Minimum Open Circuit Voltage @ ILED = 10mA, 25°C, RL = >10MΩ (see figures 1 to 2)	5.0	5.0/channel 10 series	V <sub>(DC)</sub>
Minimum Short Circuit Current @ ILED = 10mA, 25°C (see figures 1 to 2)	5.0	5.0/channel 10 series	μA <sub>(DC)</sub>
Maximum Capacitance (Input/Output)	1.0	2.0	pF
Maximum Ton Time @ ILED=10mA, CLOAD=10pF (See Figure7) RL > 20MΩ RL=10MΩ RL=4.7MΩ	300		μS
	160		μS
	90		μS
Maximum Toff Time @ ILED=10mA, CLOAD=10pF (See Figure7)	220		μS

<b>GENERAL CHARACTERISTICS</b>	<b>Limits PVI5050N</b>	<b>Limits PVI1050N</b>	<b>Units</b>
Minimum Dielectric Strength, Input-Output	4000	2500	V <sub>RMS</sub>
Minimum Dielectric Strength, Output-to-Output	1200		V <sub>DC</sub>
Minimum Insulation Resistance, Input-to-Output, @T <sub>A</sub> =+25°C, 50%RH, 100V <sub>DC</sub>	10 <sup>12</sup>		Ω
Maximum Pin Soldering Temperature (10 seconds maximum)	+260		°C
Ambient Temperature Range:                      Operating	-40 to 85		
Storage	-40 to 125		

Infineon Technology does not recommend the use of this product in aerospace, avionics, military or life support applications. Users of this Infineon Technology product in such applications assume all risks of such use and indemnify Infineon Technology against all damages resulting from such use.

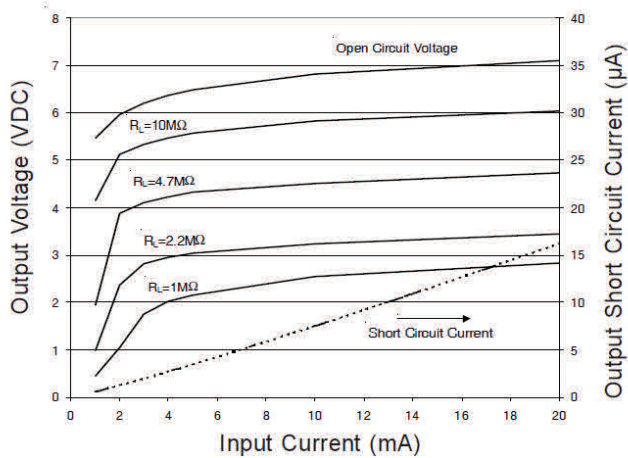

Figure 1. Typical Output Characteristics

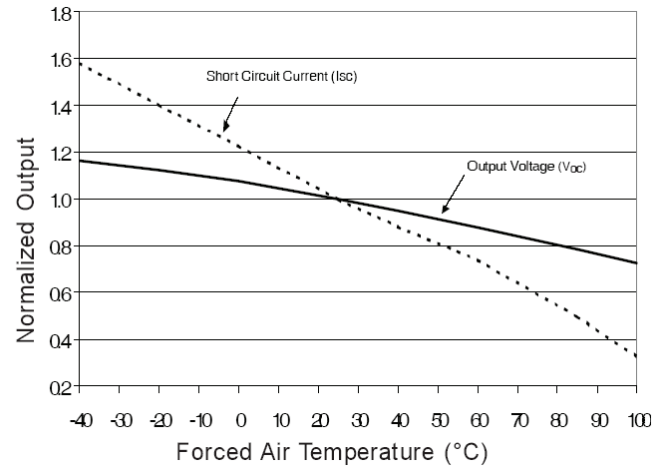

Figure 2. Typical Variation of Output

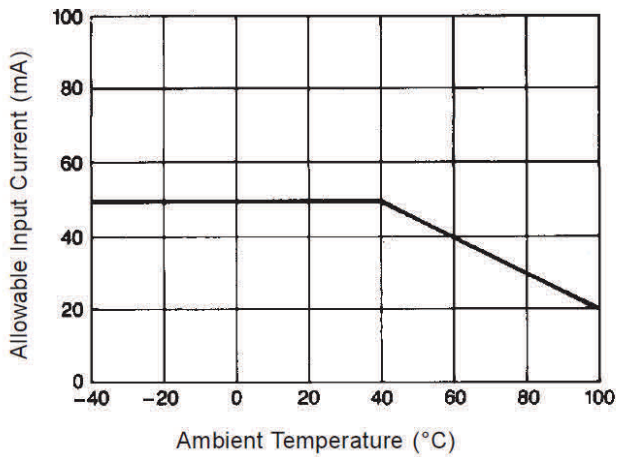

Figure 3. Input Current Derating

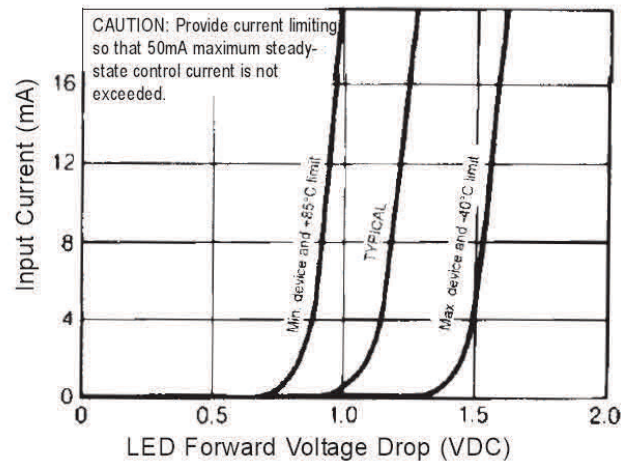

Figure 4. Input Characteristics

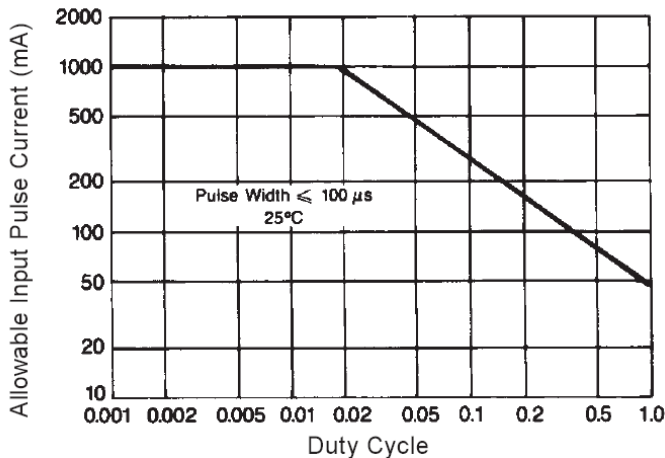

Figure 5. Input Pulse Capability

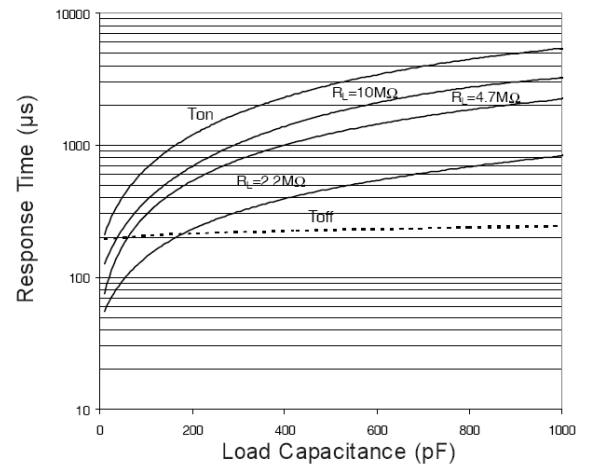
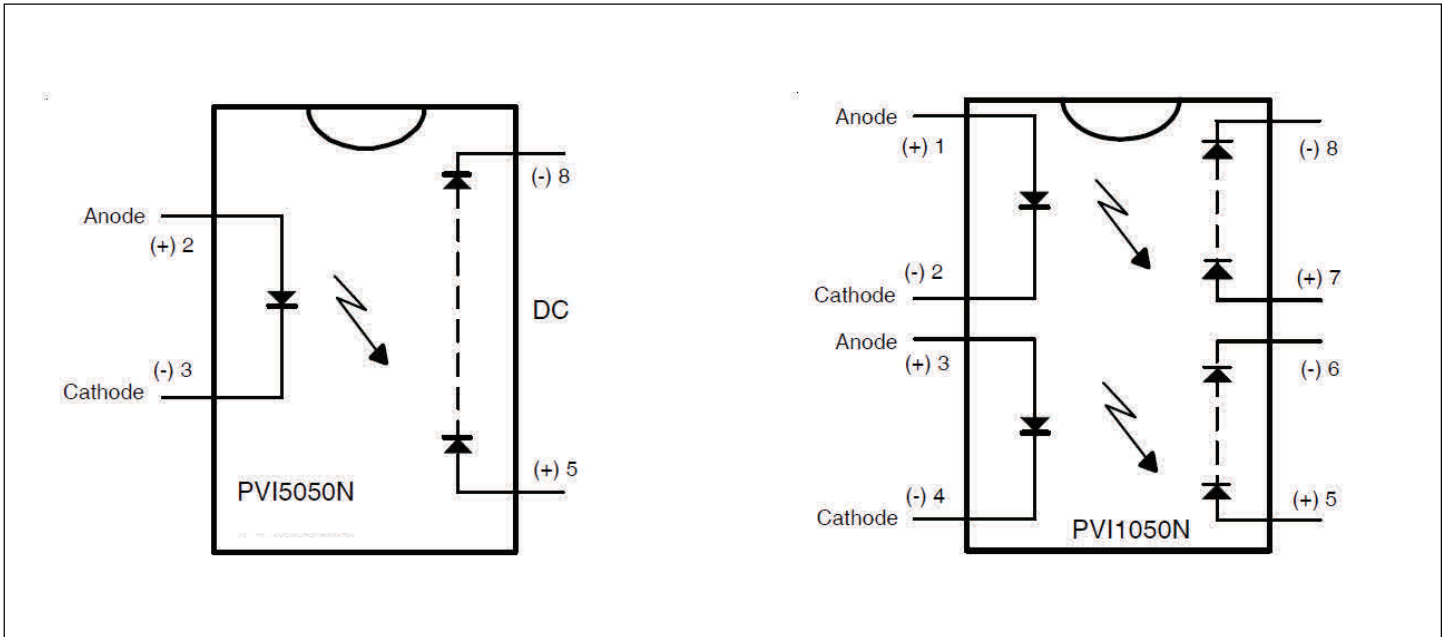

Figure 6. Typical Response Time

## Wiring Diagram



### Application Note:

The outputs of the PVI1050N (pins 5-6 and 7-8) may be placed in series connection to produce a 10-volt output with a 5 $\mu$ A minimum short circuit current. Alternatively, the two outputs of the PVI1050 may be connected in parallel to produce a 5.0-volt output with a 10 $\mu$ A minimum short circuit current.

The two outputs of the PVI1050N may be applied separately with a maximum 1200VDC between the outputs. Input-to-output isolation to either output is 2500V (RMS).

### Case Outlines

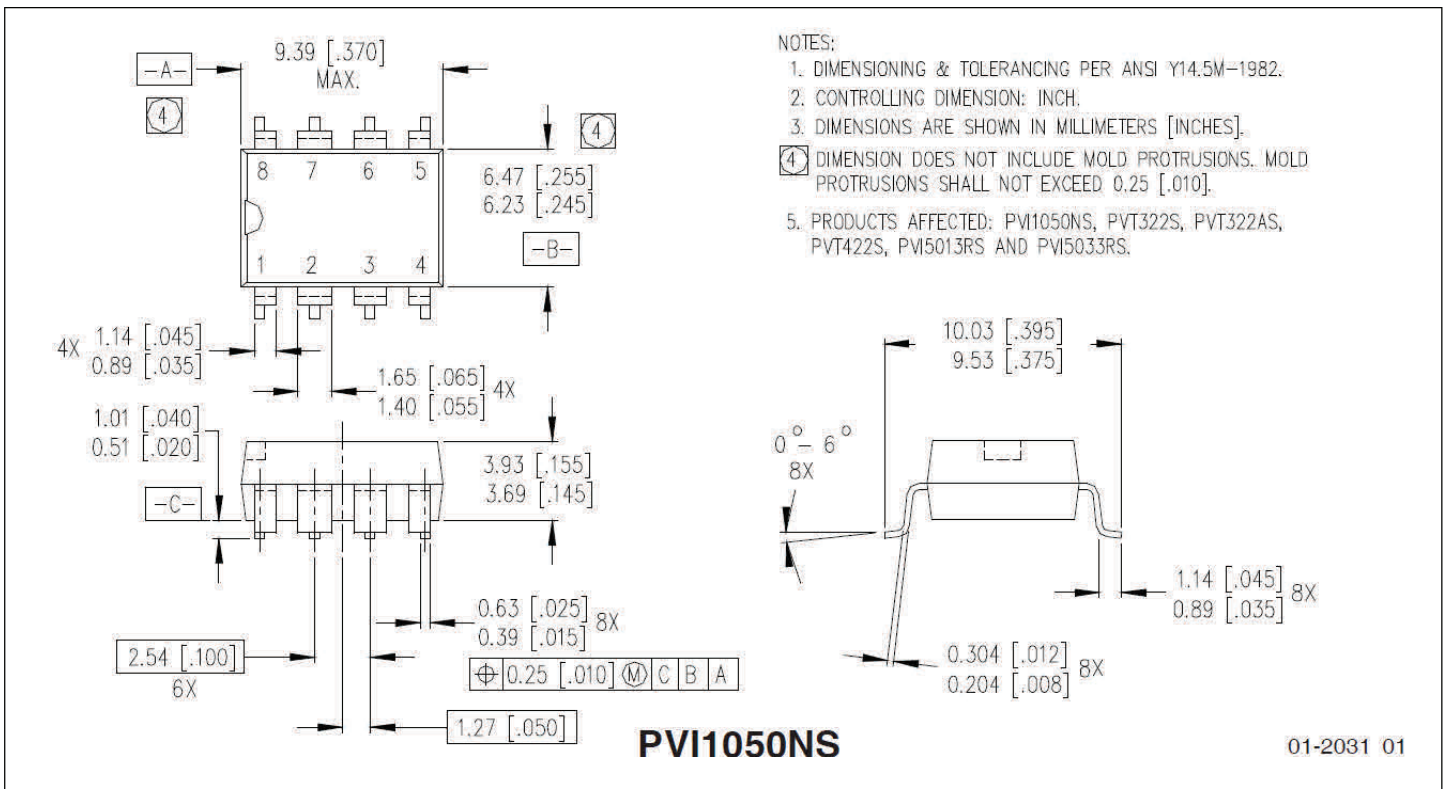
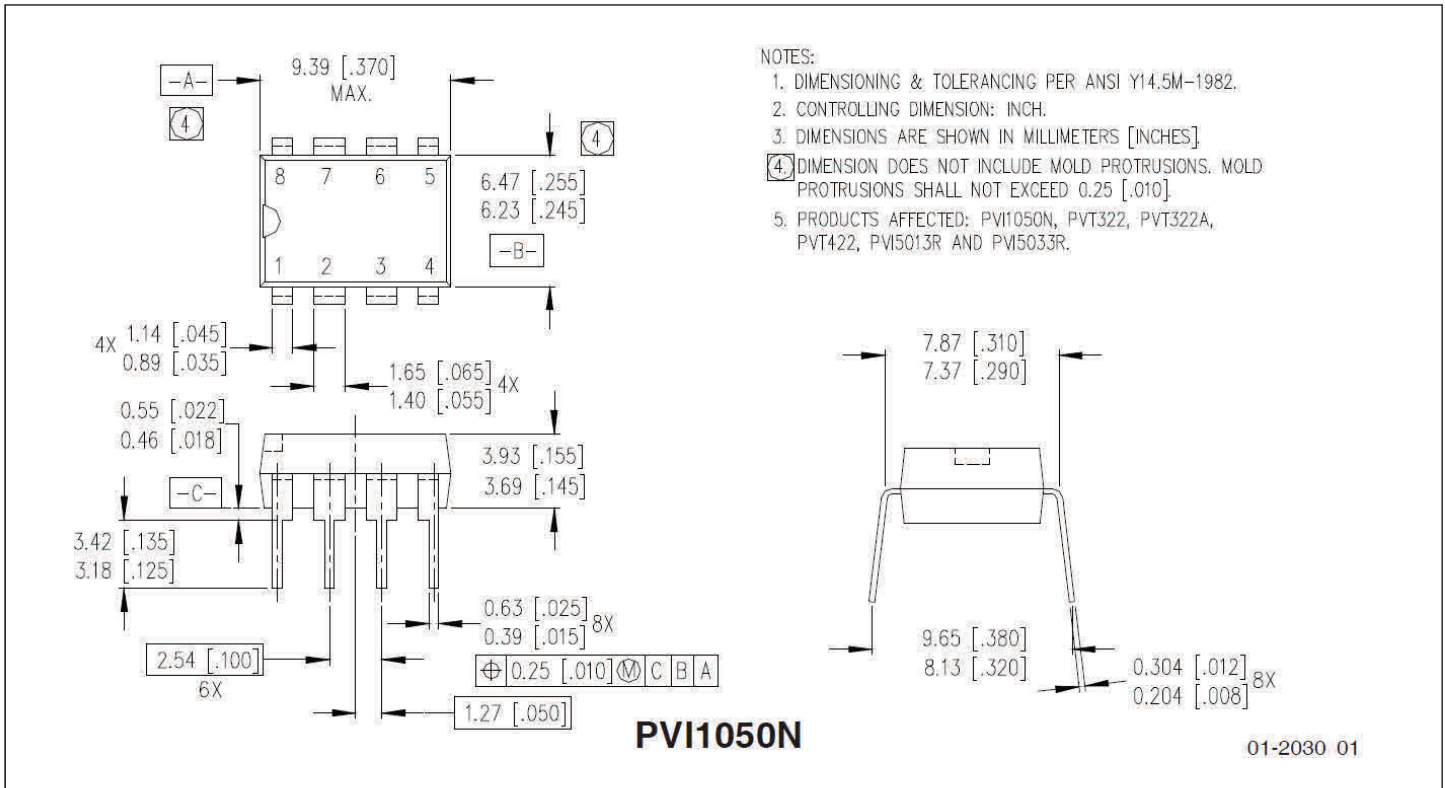

### Case Outlines

**NOTES:**

1. DIMENSIONING & TOLERANCING PER ANSI Y14.5M-1982.
2. CONTROLLING DIMENSION: INCH.
3. DIMENSIONS ARE SHOWN IN MILLIMETERS (INCHES).
4. OUTLINE CONFORMS TO JEDEC OUTLINE MS-001AB.
5. MEASURED WITH THE LEADS CONSTRAINED TO BE PERPENDICULAR TO DATUM PLANE C.

**PVI5050N** 01-2013 00 (MS-001AB)

**NOTES:**

1. DIMENSIONING & TOLERANCING PER ANSI Y14.5M-1982.
2. CONTROLLING DIMENSION: INCH.
3. DIMENSIONS ARE SHOWN IN MILLIMETERS (INCHES).
4. DIMENSION DOES NOT INCLUDE MOLD PROTUSIONS. MOLD PROTUSIONS SHALL NOT EXCEED 0.25 (.010).

**PVI5050NS** 01-2019 00

**Qualification Information**

<b>Qualification Level</b>	Industrial (per JEDEC JESD47F <sup>†</sup> guidelines)	
<b>Moisture Sensitivity Level</b>	PVI1050NPbF	N/A
	PVI5050NPbF	
	PVI1050NSPbF	MSL4  (per JEDEC J-STD-020E & JEDEC J-STD-033C) <sup>†</sup>
	PVI5050NSPbF	
PVI1050NS-TPbF		
<b>RoHS Compliant</b>	Yes	

† Applicable version of JEDEC standard at the time of product release.



#### Trademarks of Infineon Technologies AG

$\mu$ HVIC™,  $\mu$ IPM™,  $\mu$ PFC™, AU-ConvertIR™, AURIX™, C166™, CanPAK™, CIPOS™, CIPURSE™, CoolDP™, CoolGaN™, COOLiR™, CoolMOS™, CoolSET™, CoolSiC™, DAVE™, DI-POL™, DirectFET™, DrBlade™, EasyPIM™, EconoBRIDGE™, EconoDUAL™, EconoPACK™, EconoPIM™, EiceDRIVER™, eupec™, FCOS™, GaNpowIR™, HEXFET™, HITFET™, HybridPACK™, iMOTION™, IRAM™, ISOFACE™, IsoPACK™, LEDrivIR™, LITIX™, MIPAQ™, ModSTACK™, my-d™, NovalithIC™, OPTIGA™, OptiMOS™, ORIGA™, PowIRaudio™, PowIRstage™, PrimePACK™, PrimeSTACK™, PROFET™, PRO-SIL™, RASIC™, REAL3™, SmartLEWIS™, SOLID FLASH™, SPOC™, StrongIRFET™, SuplIRBuck™, TEMPFET™, TRENCHSTOP™, TriCore™, UHVIC™, XHP™, XMC™

Trademarks updated November 2015

#### Other Trademarks

All referenced product or service names and trademarks are the property of their respective owners.

**Edition 2016-04-19**

**Published by**

**Infineon Technologies AG**  
81726 Munich, Germany

© 2016 Infineon Technologies AG.  
All Rights Reserved.

**Do you have a question about this document?**

**Email:** [erratum@infineon.com](mailto:erratum@infineon.com)

**Document reference**  
ifx1

#### IMPORTANT NOTICE

The information given in this document shall in no event be regarded as a guarantee of conditions or **characteristics ("Beschaffheitsgarantie")**.

With respect to any examples, hints or any typical values stated herein and/or any information regarding the application of the product, Infineon Technologies hereby disclaims any and all warranties and liabilities of any kind, including without limitation warranties of non-infringement of intellectual property rights of any third party.

In addition, any information given in this document **is subject to customer's compliance with its obligations** stated in this document and any applicable legal requirements, norms and standards concerning customer's products and any use of the product of Infineon Technologies in **customer's applications**.

The data contained in this document is exclusively intended for technically trained staff. It is the **responsibility of customer's technical departments** to evaluate the suitability of the product for the intended application and the completeness of the product information given in this document with respect to such application.

For further information on the product, technology, delivery terms and conditions and prices please contact your nearest Infineon Technologies office ([www.infineon.com](http://www.infineon.com)).

Please note that this product is not qualified according to the AEC Q100 or AEC Q101 documents of the Automotive Electronics Council.

#### WARNINGS

Due to technical requirements products may contain dangerous substances. For information on the types in question please contact your nearest Infineon Technologies office.

Except as otherwise explicitly approved by Infineon Technologies in a written document signed by authorized representatives of Infineon Technologies, **Infineon Technologies' products may not be used** in any applications where a failure of the product or any consequences of the use thereof can reasonably be expected to result in personal injury.



单击下面可查看定价，库存，交付和生命周期等信息

[>>Infineon Technologies\(英飞凌\)](#)

[>>点击查看相关商品](#)