

TPSMB-VR Series



Agency Recognitions

AGENCY	AGENCY FILE NUMBER
	E230531

Maximum Ratings and Thermal Characteristics (T_A = 25°C unless otherwise noted)

Parameter	Symbol	Value	Unit
Peak Pulse Power Dissipation by 10/1000µs waveform (Fig.1)(Note 1), (Note 2)	P _{PPM}	600	W
Power Dissipation on infinite heat sink at T _L = 50°C	P _{M(AV)}	5.0	W
Peak Forward Surge Current, 8.3ms Single Half Sine Wave (Note 3)	I _{FSM}	100	A
Maximum Instantaneous Forward Voltage at 50A for Unidirectional only	V _F	3.5V	V
Operating Junction Temperature Range (V _R ≤ 78V)	T _J	-65 to 175	°C
Operating Junction Temperature Range (V _R > 78V)	T _J	-65 to 150	°C
Storage Temperature Range	T _{STG}	-65 to 175	°C
Typical Thermal Resistance Junction to Lead	R _{uJL}	20	°C/W
Typical Thermal Resistance Junction to Ambient	R _{uJA}	100	°C/W

Notes:

1. Non-repetitive current pulse per Fig. 4 and derated above T_A = 25°C per Fig. 3.
2. Mounted on copper pad area of 0.2x0.2" (5.0 x 5.0mm) to each terminal.
3. Measured on 8.3ms single half sine wave or equivalent square wave for unidirectional component only, duty cycle=4 per minute maximum.

Functional Diagram

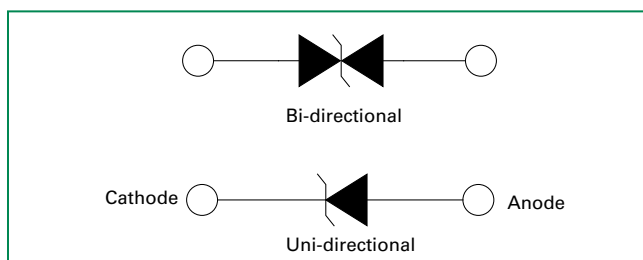

Description

The TPSMB-VR series is designed specifically to protect sensitive electronic equipment from voltage transients induced by lightning and other transient voltage events.

Features

- High reliability application and automotive grade AEC Q101 qualified
- Surface mount component to minimize board space
- Low profile package
- Typical failure mode is short from over-specified voltage or current
- Whisker test is conducted based on JEDEC JESD201A per its table 4a and 4c
- ESD protection of data lines in accordance with IEC 61000-4-2, 30kV(Air), 30kV (Contact)
- EFT protection of data lines in accordance with IEC 61000-4-4
- Glass passivated chip junction
- 600W peak pulse power capability at 10/1000µs waveform, repetition rate (duty cycles):0.01 %
- Fast response time: typically less than 1.0ns from 0V to V_{BR} min
- Excellent clamping capability
- Low incremental surge resistance
- Typical I_R ≤ 1µA for V_R > 10V
- High temperature soldering guaranteed: 260°C/10 seconds at terminals
- UL Recognized compound meeting flammability rating V-0.
- Meet MSL level1, per J-STD-020, high temperature soldering guaranteed.
- Matte tin lead-free plated
- Halogen free and RoHS compliant
- Pb-free E3 means 2nd level interconnect is Pb-free and the terminal finish material is tin(Sn) (IPC/ JEDEC J-STD-609A.01)

Applications

TVS components are ideal for the protection of I/O Interfaces, V_{CC} bus and other vulnerable circuits used in Automotive applications.

Electrical Characteristics ($T_A=25^\circ\text{C}$ unless otherwise noted)

Part Number (Uni)	Part Number (Bi)	Marking		Typical I_R @ 150°C (μA)	Reverse Stand off Voltage V_R (Volts)	Breakdown Voltage V_{BR} (Volts) @ I_T		Test Current I_T (mA)	Maximum Clamping Voltage V_C @ I_{PP} (V)	Maximum Peak Pulse Current I_{PP} (A)	Maximum Reverse Leakage I_R @ V_R (μA)	Maximum Temperature coefficient of V_{BR} (%/C)	Agency Approval 
		UNI	BI			MIN	MAX						
TPSMB6.5A-VR	-	KKA	-	500	6.5	7.22	7.98	10	11.2	53.6	500	0.052	
TPSMB7.0A-VR	-	KMA	-	200	7.0	7.78	8.60	10	12.0	50.0	200	0.058	
TPSMB7.5A-VR	-	KPA	-	100	7.5	8.33	9.21	1	12.9	46.6	100	0.061	X
TPSMB8.0A-VR	-	KRA	-	50	8.0	8.89	9.83	1	13.6	44.2	50	0.064	
TPSMB8.5A-VR	TPSMB8.5CA-VR	KTA	ATA	50	8.5	9.44	10.40	1	14.4	41.7	20	0.066	
TPSMB9.0A-VR	TPSMB9.0CA-VR	KVA	AVA	20	9.0	10.00	11.10	1	15.4	39.0	10	0.069	
TPSMB10A-VR	TPSMB10CA-VR	KXA	AXA	8	10.0	11.10	12.30	1	17.0	35.3	5	0.071	X
TPSMB11A-VR	TPSMB11CA-VR	KZA	AZA	8	11.0	12.20	13.50	1	18.2	33.0	1	0.074	X
TPSMB12A-VR	TPSMB12CA-VR	LEA	BEA	8	12.0	13.30	14.70	1	19.9	30.2	1	0.075	X
TPSMB13A-VR	TPSMB13CA-VR	LGA	BGA	8	13.0	14.40	15.90	1	21.5	28.0	1	0.076	X
TPSMB14A-VR	TPSMB14CA-VR	LKA	BKA	8	14.0	15.60	17.20	1	23.2	25.9	1	0.080	
TPSMB15A-VR	TPSMB15CA-VR	LMA	BMA	8	15.0	16.70	18.50	1	24.4	24.6	1	0.083	X
TPSMB16A-VR	TPSMB16CA-VR	LPA	BPA	8	16.0	17.80	19.70	1	26.0	23.1	1	0.084	X
TPSMB17A-VR	TPSMB17CA-VR	LRA	BRA	8	17.0	18.90	20.90	1	27.6	21.8	1	0.085	
TPSMB18A-VR	TPSMB18CA-VR	LTA	BTA	8	18.0	20.00	22.10	1	29.2	20.6	1	0.088	X
TPSMB20A-VR	TPSMB20CA-VR	LVA	BVA	8	20.0	22.20	24.50	1	32.4	18.6	1	0.091	X
TPSMB22A-VR	TPSMB22CA-VR	LXA	BXA	8	22.0	24.40	26.90	1	35.5	16.9	1	0.092	X
TPSMB24A-VR	TPSMB24CA-VR	LZA	BZA	8	24.0	26.70	29.50	1	38.9	15.5	1	0.092	X
TPSMB26A-VR	TPSMB26CA-VR	MEA	CEA	8	26.0	28.90	31.90	1	42.1	14.3	1	0.093	
TPSMB28A-VR	TPSMB28CA-VR	MGA	CGA	8	28.0	31.10	34.40	1	45.4	13.3	1	0.094	
TPSMB30A-VR	TPSMB30CA-VR	MKA	CKA	8	30.0	33.30	36.80	1	48.4	12.4	1	0.096	X
TPSMB33A-VR	TPSMB33CA-VR	MMA	CMA	8	33.0	36.70	40.60	1	53.3	11.3	1	0.097	X
TPSMB36A-VR	TPSMB36CA-VR	MPA	CPA	8	36.0	40.00	44.20	1	58.1	10.4	1	0.098	X
TPSMB40A-VR	TPSMB40CA-VR	MRA	CRA	8	40.0	44.40	49.10	1	64.5	9.3	1	0.099	
TPSMB43A-VR	TPSMB43CA-VR	MTA	CTA	8	43.0	47.80	52.80	1	69.4	8.7	1	0.100	X
TPSMB45A-VR	TPSMB45CA-VR	MVA	CVA	8	45.0	50.00	55.30	1	72.7	8.3	1	0.101	
TPSMB48A-VR	TPSMB48CA-VR	MXA	CXA	8	48.0	53.30	58.90	1	77.4	7.8	1	0.101	
TPSMB51A-VR	TPSMB51CA-VR	MZA	CZA	8	51.0	56.70	62.70	1	82.4	7.3	1	0.101	X
TPSMB54A-VR	TPSMB54CA-VR	NEA	DEA	8	54.0	60.00	66.30	1	87.1	6.9	1	0.102	
TPSMB58A-VR	TPSMB58CA-VR	NGA	DGA	8	58.0	64.40	71.20	1	93.6	6.5	1	0.103	
TPSMB60A-VR	TPSMB60CA-VR	NKA	DKA	8	60.0	66.70	73.70	1	96.8	6.2	1	0.103	
TPSMB64A-VR	TPSMB64CA-VR	NMA	DMA	8	64.0	71.10	78.60	1	103.0	5.9	1	0.104	
TPSMB70A-VR	TPSMB70CA-VR	NPA	DPA	8	70.0	77.80	86.00	1	113.0	5.3	1	0.105	
TPSMB75A-VR	TPSMB75CA-VR	NRA	DRA	8	75.0	83.30	92.10	1	121.0	5.0	1	0.106	X
TPSMB78A-VR	TPSMB78CA-VR	NTA	DTA	8	78.0	86.70	95.80	1	126.0	4.8	1	0.106	
TPSMB85A-VR	TPSMB85CA-VR	NVA	DVA	8	85.0	94.40	104.00	1	137.0	4.4	1	0.106	
TPSMBJ90A-VR	TPSMBJ90CA-VR	NXA	DXA	8	90.0	100.00	111.00	1	146.0	4.1	1	0.107	
TPSMBJ100A-VR	TPSMBJ100CA-VR	NZA	DZA	8	100.0	111.00	123.00	1	162.0	3.7	1	0.107	X
TPSMBJ110A-VR	TPSMBJ110CA-VR	PEA	EEA	8	110.0	122.00	135.00	1	177.0	3.4	1	0.107	X
TPSMBJ120A-VR	TPSMBJ120CA-VR	PGA	EGA	8	120.0	133.00	147.00	1	193.0	3.1	1	0.108	X
TPSMBJ130A-VR	TPSMBJ130CA-VR	PKA	EKA	8	130.0	144.00	159.00	1	209.0	2.9	1	0.108	X
TPSMBJ150A-VR	TPSMBJ150CA-VR	PMA	EMA	8	150.0	167.00	185.00	1	243.0	2.5	1	0.108	X
TPSMBJ160A-VR	TPSMBJ160CA-VR	PPA	EPA	8	160.0	178.00	197.00	1	259.0	2.3	1	0.108	X
TPSMBJ170A-VR	TPSMBJ170CA-VR	PRA	ERA	8	170.0	189.00	209.00	1	275.0	2.2	1	0.108	X
TPSMBJ180A-VR	TPSMBJ180CA-VR	PTA	ETA	8	180.0	201.00	222.00	1	292.0	2.1	1	0.108	X
TPSMBJ188A-VR	TPSMBJ188CA-VR	PBA	EBA	8	188.0	209.00	231.00	1	304.0	2.0	1	0.110	
TPSMBJ200A-VR	TPSMBJ200CA-VR	PVA	EVA	8	200.0	224.00	247.00	1	324.0	1.9	1	0.110	X
TPSMBJ220A-VR	TPSMBJ220CA-VR	PXA	EXA	8	220.0	246.00	272.00	1	356.0	1.7	1	0.110	X
TPSMBJ250A-VR	TPSMBJ250CA-VR	PZA	EZA	8	250.0	279.00	309.00	1	405.0	1.5	1	0.110	X
TPSMBJ300A-VR	TPSMBJ300CA-VR	QEA	FEA	8	300.0	335.00	371.00	1	486.0	1.3	1	0.112	
TPSMBJ350A-VR	TPSMBJ350CA-VR	QGA	FGA	8	350.0	391.00	432.00	1	567.0	1.1	1	0.112	
TPSMBJ400A-VR	TPSMBJ400CA-VR	QKA	FKA	8	400.0	447.00	494.00	1	648.0	0.9	1	0.112	
TPSMBJ440A-VR	TPSMBJ440CA-VR	QMA	FMA	8	440.0	492.00	543.00	1	713.0	0.9	1	0.112	

For bidirectional type having V_R of 10 volts and less, the I_R limit is double.
 $V_{BR} @ T_J = V_{BR} @ 25^\circ\text{C} \times (1 + \alpha T \times (T_J - 25))$ (α T: Temperature Coefficient, typical value is 0.1%)

I-V Curve Characteristics

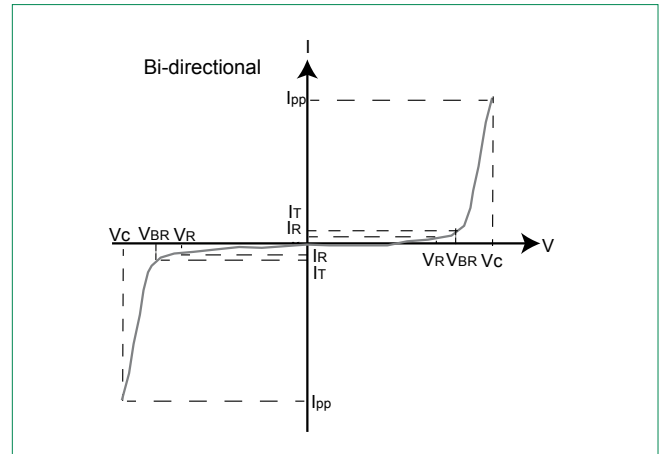
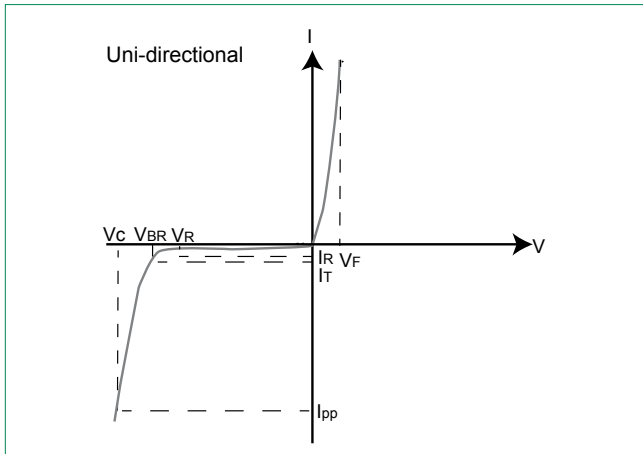

- P_{PPM} Peak Pulse Power Dissipation** – Max power dissipation
- V_R Stand-off Voltage** – Maximum voltage that can be applied to the TVS without operation
- V_{BR} Breakdown Voltage** – Maximum voltage that flows though the TVS at a specified test current (I_T)
- V_c Clamping Voltage** – Peak voltage measured across the TVS at a specified I_{ppm} (peak impulse current)
- I_R Reverse Leakage Current** – Current measured at V_R
- V_F Forward Voltage Drop for Uni-directional**

Ratings and Characteristic Curves ($T_A=25^\circ\text{C}$ unless otherwise noted)

Figure 1 - TVS Transients Clamping Waveform

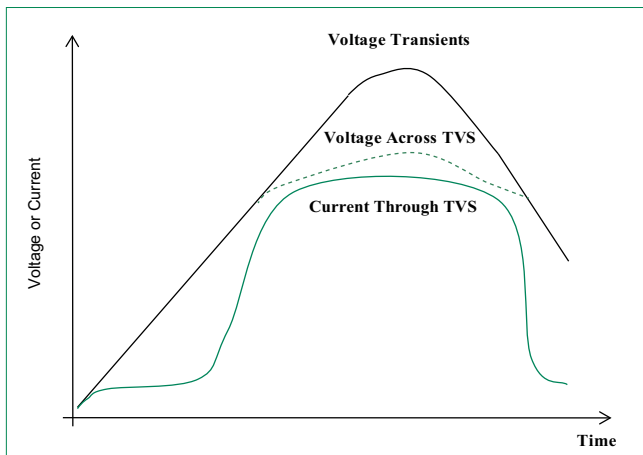
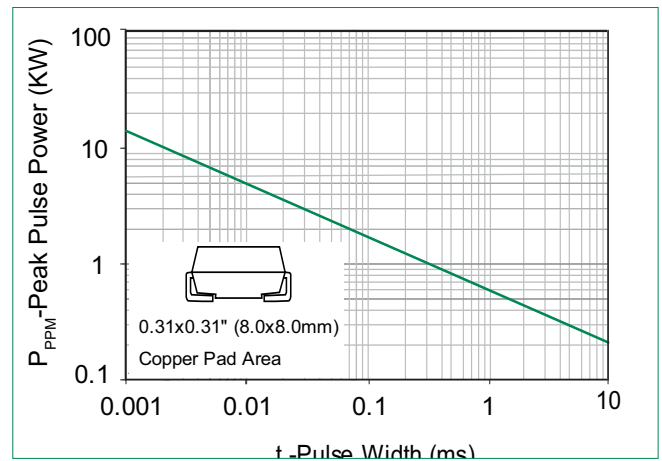

Figure 2 - Peak Pulse Power Rating Curve



continues on next page.

Ratings and Characteristic Curves ($T_A=25^\circ\text{C}$ unless otherwise noted) (Continued)

Figure 3 - Peak Pulse Power Derating Curve

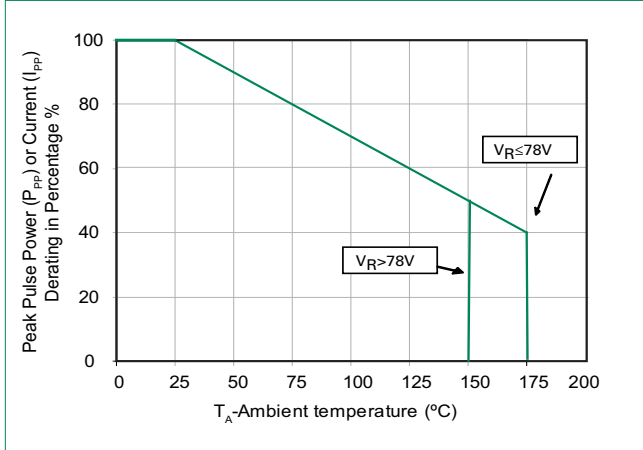

Figure 4 - Pulse Waveform

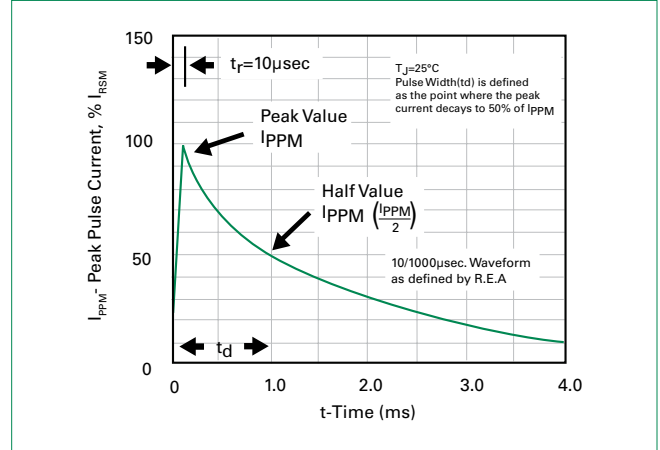

Figure 5 - Typical Junction Capacitance

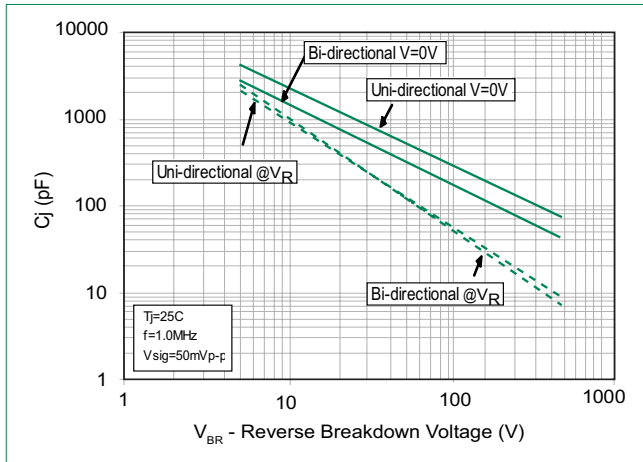
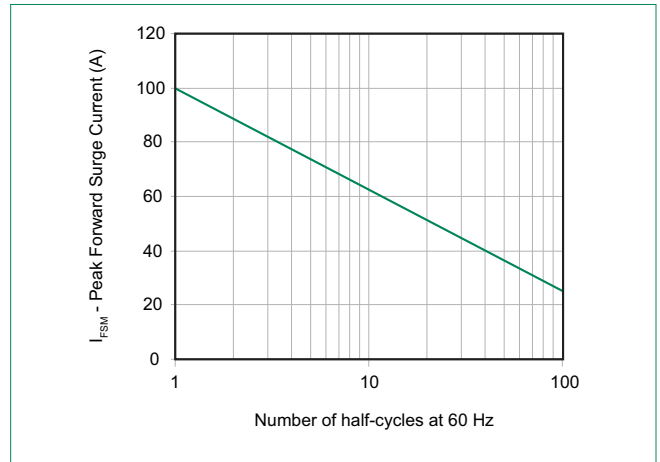
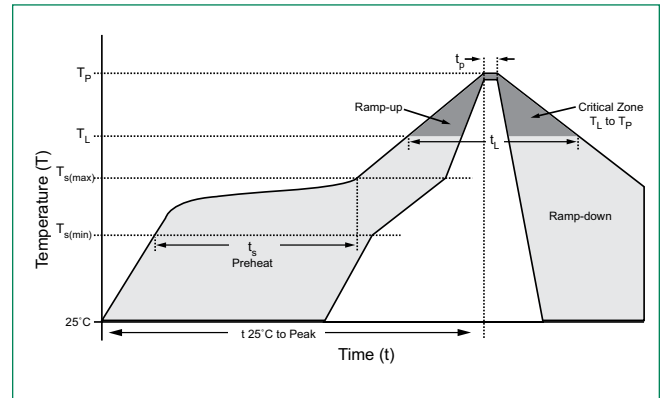

Figure 6 - Maximum Non-Repetitive Peak Forward Surge Current Uni-Directional Only



Soldering Parameters

Reflow Condition		Lead-free assembly
Pre Heat	- Temperature Min ($T_{s(min)}$)	150°C
	- Temperature Max ($T_{s(max)}$)	200°C
	- Time (min to max) (t_s)	60 – 120 secs
Average ramp up rate (Liquidus Temp (T_L) to peak)		3°C/second max
$T_{s(max)}$ to T_L - Ramp-up Rate		3°C/second max
Reflow	- Temperature (T_L) (Liquidus)	217°C
	- Time (min to max) (t_s)	60 – 150 seconds
Peak Temperature (T_p)		260 ^{+0/-5} °C
Time within 5°C of actual peak Temperature (t_p)		30 seconds max
Ramp-down Rate		6°C/second max
Time 25°C to peak Temperature (T_p)		8 minutes max.
Do not exceed		260°C



Physical Specifications

Weight	0.003 ounce, 0.093 grams
Case	JEDEC DO214AA. Molded plastic body over glass passivated junction
Polarity	Color band denotes cathode for unidirectional components
Terminal	Matte Tin-plated leads, Solderable per JESD22-B102

Environmental Specifications

High Temp. Storage	JESD22-A103
HTRB	JESD22-A108
Temperature Cycling	JESD22-A104
MSL	JEDEC-J-STD-020, Level 1
H3TRB	JESD22-A101
RSH	JESD22-A111

Dimensions

DO-214AA (SMB J-Bend)

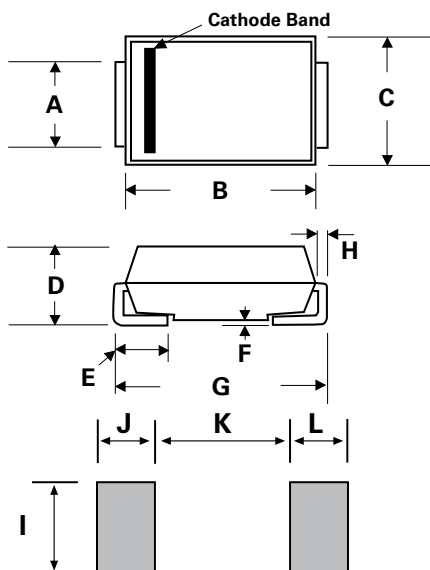

Dimensions	Inches		Millimeters	
	Min	Max	Min	Max
A	0.077	0.086	1.950	2.200
B	0.160	0.180	4.060	4.570
C	0.130	0.155	3.300	3.940
D	0.084	0.096	2.130	2.440
E	0.030	0.060	0.760	1.520
F	-	0.008	-	0.203
G	0.205	0.220	5.210	5.590
H	0.006	0.012	0.152	0.305
I	0.089	-	2.260	-
J	0.085	-	2.160	-
K	-	0.107	-	2.740
L	0.085	-	2.160	-

Part Numbering System

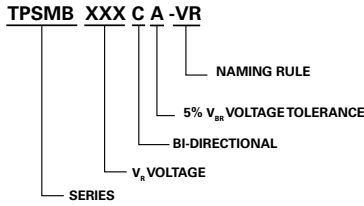

Part Marking System

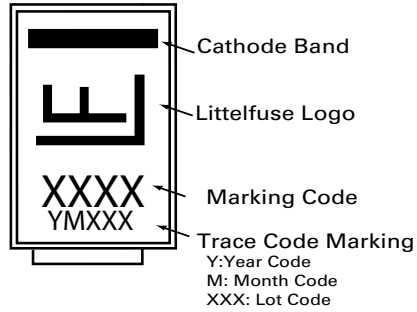

Packaging

Part number	Component Package	Quantity	Packaging Option	Packaging Specification
TPSMBxxxXX-VR	DO-214AA	3000	Tape & Reel - 12mm tape/13" reel	EIA STD RS-481

Tape and Reel Specification

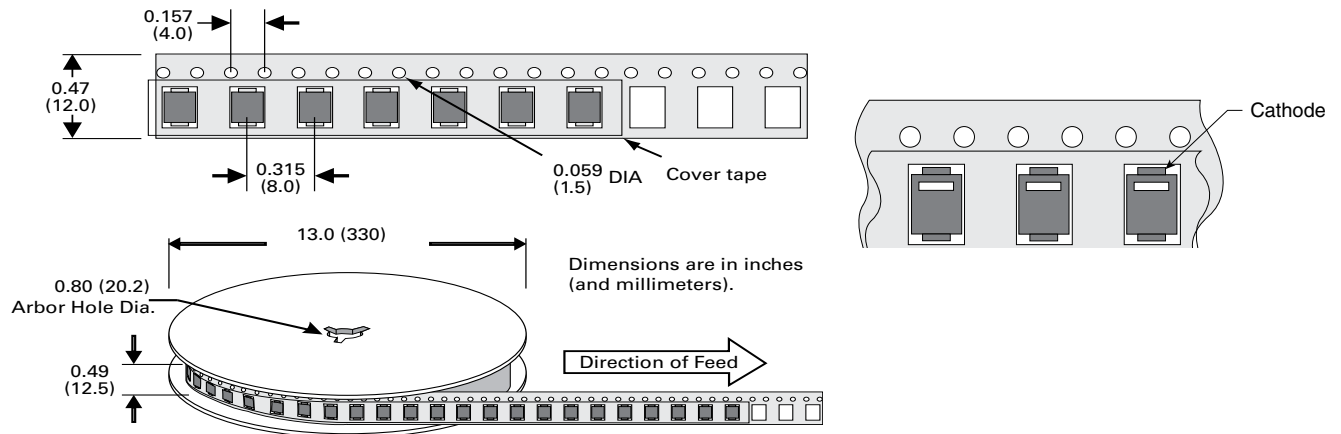

Disclaimer Notice - Information furnished is believed to be accurate and reliable. However, users should independently evaluate the suitability of and test each product selected for their own applications. Littelfuse products are not designed for, and may not be used in, all applications. Read complete Disclaimer Notice at <http://www.littelfuse.com/disclaimer-electronics>.

单击下面可查看定价，库存，交付和生命周期等信息

[>>Littelfuse\(美国力特\)](#)