



LM2940

LINEAR INTEGRATED CIRCUIT

1A LOW-DROPOUT POSITIVE VOLTAGE REGULATOR

DESCRIPTION

The UTC **LM2940** is a low dropout regulator designed to provide output current up to 1A with a typically 500mV dropout Voltage and a maximum of 1V. It is capable of reducing the ground current when the differential between the input voltage and the output voltage outrun 3V.

UTC **LM2940** offers low quiescent current (typically 30mA at 1A and an input-output differential of 5V). Higher quiescent currents only exist when the regulator is in the dropout mode ($V_{IN}-V_{OUT} \leq 3V$).

FEATURES

- * 500mV Typically Dropout at 1A
- * Output Current in Excess of 1A
- * Low Quiescent Current
- * Reversed-Battery Protection
- * Current Limit and Thermal Shutdown.
- * Mirror Image Insertion Protection

ORDERING INFORMATION

Ordering Number		Package	Pin Assignment			Packing
Lead Free	Halogen Free		1	2	3	
-	LM2940G-xx-AA3-R	SOT-223	I	G	O	Tape Reel
LM2940L-xx-TA3-T	LM2940G-xx-TA3-T	TO-220	I	G	O	Tube
LM2940L-xx-TF3-T	LM2940G-xx-TF3-T	TO-220F	I	G	O	Tube
LM2940L-xx-TN3-R	LM2940G-xx-TN3-R	TO-252	I	G	O	Tape Reel
LM2940L-xx-TQ2-R	LM2940G-xx-TQ2-R	TO-263	I	G	O	Tape Reel
LM2940L-xx-TQ2-T	LM2940G-xx-TQ2-T	TO-263	I	G	O	Tube
LM2940L-xx-TQ3-R	LM2940G-xx-TQ3-R	TO-263-3	I	G	O	Tape Reel
LM2940L-xx-TQ3-T	LM2940G-xx-TQ3-T	TO-263-3	I	G	O	Tube

Notes: 1. xx: Output Voltage, refer to Marking Information.

2. Pin Assignment: I: V_{IN} G: GND O: V_{OUT}

<p>LM2940G-xx-AA3-R</p> <p>(1) Packing Type (2) Package Type (3) Output Voltage Code (4) Green Package</p>	<p>(1) R: Tape Reel, T: Tube (2) AA3: SOT-223, TA3: TO-220, TF3: TO-220F TN3: TO-252, TQ2: TO-263, TQ3: TO-263-3 (3) xx: refer to Marking Information (4) G: Halogen Free and Lead Free, L: Lead Free</p>
--	---

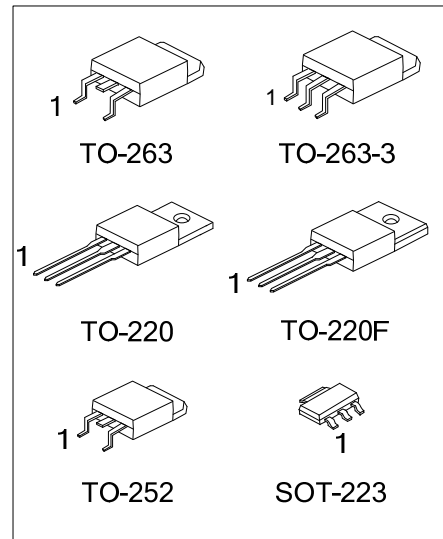

MARKING INFORMATION

PACKAGE	VOLTAGE CODE	MARKING
SOT-223	50 : 5V 60 : 6V 80 : 8V 90 : 9V 10 : 10V 12 : 12V 15 : 15V	
TO-220 TO-252 TO-263 TO-263-3	50 : 5V 60 : 6V 80 : 8V 90 : 9V 10 : 10V 12 : 12V 15 : 15V	

■ ABSOLUTE MAXIMUM RATINGS

PARAMETER		SYMBOL	RATINGS	UNIT
Input Voltage		V_{IN}	26	V
Power Dissipation		P_D	Internally limited	
Junction Temperature		T_J	+150	°C
Ambient Operating Temperature	TO-220/TO-220F	T_{OPR}	-40 ~ +125	°C
	TO-263-3/TO-263			
	SOT-223/ TO-252			
Storage Temperature		T_{STG}	-65 ~ +150	°C

Note: Absolute maximum ratings are those values beyond which the device could be permanently damaged. Absolute maximum ratings are stress ratings only and functional device operation is not implied.

■ THERMAL DATA

PARAMETER		SYMBOL	RATING	UNIT
Junction to Ambient	SOT-223	θ_{JA}	174	°C/W
	TO-220/TO-220F		60	
	TO-263/TO-263-3		80	
	TO-252		125	
Junction to Case	TO-220/TO-263	θ_{JC}	4	°C/W
	TO-263-3		6	
	TO-220F		12	
	TO-252		15	
	SOT-223		15	

■ ELECTRICAL CHARACTERISTICS

($T_A=T_J=25^\circ\text{C}$, $V_{IN}=V_{OUT}+5\text{V}$, $I_{OUT}=1\text{A}$ and $C_{OUT}=22\mu\text{F}$, unless otherwise specified.)

For LM2940-5.0V

PARAMETER	SYMBOL	TEST CONDITIONS	MIN	TYP	MAX	UNIT
Output Voltage	V_{OUT}	$6.25\text{V} \leq V_{IN} \leq 26\text{V}$, $5\text{mA} \leq I_{OUT} \leq 1\text{A}$	4.85	5.00	5.15	V
Line Regulation	ΔV_{OUT}	$V_{OUT}+2\text{V} \leq V_{IN} \leq 26\text{V}$, $I_{OUT}=5\text{mA}$		20	50	mV
Load Regulation	ΔV_{OUT}	$50\text{mA} \leq I_{OUT} \leq 1\text{A}$		35	50	mV
Output Impedance	R_{OUT}	100 mA DC and 20mA_{RMS} , $f_o=120\text{Hz}$		35		$\text{m}\Omega$
Quiescent Current	I_Q	$V_{OUT}+2\text{V} \leq V_{IN} \leq 26\text{V}$, $I_{OUT}=5\text{mA}$		10	15	mA
Output Noise Voltage	e_N	10Hz-100kHz, $I_{OUT}=5\text{mA}$		150		μV_{RMS}
Ripple Rejection	RR	$f_o=120\text{Hz}$, 1V_{RMS} , $I_{OUT}=100\text{mA}$	54	72		dB
Long Term Stability				20		mV/1000Hr
Dropout Voltage	V_D	$I_{OUT}=1\text{A}$		0.5	0.8	V
		$I_{OUT}=100\text{mA}$		0.13	0.15	
Short Circuit Current	I_{SC}	(Note)		2.5		A
Maximum Line Transient	T_{IN}	$R_{OUT}=100\Omega$, $T \leq 100\text{ms}$	60	75		V
Reverse Polarity DC Input Voltage	V_{RIN}	$R_{OUT}=100\Omega$	-15	-30		V
Reverse Polarity Transient Input Voltage	V_{TRRI}	$R_{OUT}=100\Omega$, $T \leq 100\text{ms}$	-50	-75		V

■ ELECTRICAL CHARACTERISTICS(Cont.)

For LM2940-6.0V

PARAMETER	SYMBOL	TEST CONDITIONS	MIN	TYP	MAX	UNIT
Output Voltage	V_{OUT}	$7.5V \leq V_{IN} \leq 26V, 5mA \leq I_{OUT} \leq 1A$	5.82	6.00	6.18	V
Line Regulation	ΔV_{OUT}	$V_{OUT}+2V \leq V_{IN} \leq 26V, I_{OUT}=5mA$		20	60	mV
Load Regulation	ΔV_{OUT}	$50mA \leq I_{OUT} \leq 1A$		40	60	mV
Output Impedance	R_{OUT}	100 mA DC and $20mA_{RMS}, f_o=120Hz$		40		m Ω
Quiescent Current	I_Q	$V_{OUT}+2V \leq V_{IN} \leq 26V, I_{OUT}=5mA$		10	15	mA
Output Noise Voltage	e_N	10Hz-100kHz, $I_{OUT}=5mA$		180		μV_{RMS}
Ripple Rejection	RR	$f_o=120Hz, 1V_{RMS}, I_{OUT}=100mA$	60	72		dB
Long Term Stability				20		mV/1000Hr
Dropout Voltage	V_D	$I_{OUT}=1A$		0.5	0.8	V
		$I_{OUT}=100mA$		0.13	0.15	
Short Circuit Current	I_{SC}	(Note)		2.5		A
Maximum Line Transient	T_{IN}	$R_{OUT}=100\Omega, T \leq 100ms$	60	75		V
Reverse Polarity DC Input Voltage	V_{RIN}	$R_{OUT}=100\Omega$	-15	-30		V
Reverse Polarity Transient Input Voltage	V_{TRRI}	$R_{OUT}=100\Omega, T \leq 100ms$	-50	-75		V

For LM2940-8.0V

PARAMETER	SYMBOL	TEST CONDITIONS	MIN	TYP	MAX	UNIT
Output Voltage	V_{OUT}	$9.4V \leq V_{IN} \leq 26V, 5mA \leq I_{OUT} \leq 1A$	7.76	8.00	8.24	V
Line regulation	ΔV_{OUT}	$V_{OUT}+2V \leq V_{IN} \leq 26V, I_{OUT}=5mA$		20	80	mV
Load Regulation	ΔV_{OUT}	$50mA \leq I_{OUT} \leq 1A$		55	80	mV
Output Impedance	R_{OUT}	100 mA DC and $20mA_{RMS}, f_o=120Hz$		55		m Ω
Quiescent Current	I_Q	$V_{OUT}+2V \leq V_{IN} \leq 26V, I_{OUT}=5mA$		10	15	mA
Output Noise Voltage	e_N	10Hz-100kHz, $I_{OUT}=5mA$		240		μV_{RMS}
Ripple Rejection	RR	$f_o=120Hz, 1V_{RMS}, I_{OUT}=100mA$	54	66		dB
Long Term Stability				32		mV/1000Hr
Dropout Voltage	V_D	$I_{OUT}=1A$		0.5	0.8	V
		$I_{OUT}=100mA$		0.13	0.15	
Short Circuit Current	I_{SC}	(Note)		2.5		A
Maximum Line Transient	T_{IN}	$R_{OUT}=100\Omega, T \leq 100ms$	60	75		V
Reverse Polarity DC Input Voltage	V_{RIN}	$R_{OUT}=100\Omega$	-15	-30		V
Reverse Polarity Transient Input Voltage	V_{TRRI}	$R_{OUT}=100\Omega, T \leq 100ms$	-50	-75		V

For LM2940-9.0V

PARAMETER	SYMBOL	TEST CONDITIONS	MIN	TYP	MAX	UNIT
Output Voltage	V_{OUT}	$10.5V \leq V_{IN} \leq 26V, 5mA \leq I_{OUT} \leq 1A$	8.73	9.00	9.27	V
Line regulation	ΔV_{OUT}	$V_{OUT}+2V \leq V_{IN} \leq 26V, I_{OUT}=5mA$		20	90	mV
Load Regulation	ΔV_{OUT}	$50mA \leq I_{OUT} \leq 1A$		60	90	mV
Output Impedance	R_{OUT}	100 mA DC and $20mA_{RMS}, f_o=120Hz$		60		m Ω
Quiescent Current	I_Q	$V_{OUT}+2V \leq V_{IN} \leq 26V, I_{OUT}=5mA$		10	15	mA
Output Noise Voltage	e_N	10Hz-100kHz, $I_{OUT}=5mA$		270		μV_{RMS}
Ripple Rejection	RR	$f_o=120Hz, 1V_{RMS}, I_{OUT}=100mA$	52	64		dB
Long Term Stability				34		mV/1000Hr
Dropout Voltage	V_D	$I_{OUT}=1A$		0.5	0.8	V
		$I_{OUT}=100mA$		0.13	0.15	
Short Circuit Current	I_{SC}	(Note)		2.5		A
Maximum Line Transient	T_{IN}	$R_{OUT}=100\Omega, T \leq 100ms$	60	75		V
Reverse Polarity DC Input Voltage	V_{RIN}	$R_{OUT}=100\Omega$	-15	-30		V
Reverse Polarity Transient Input Voltage	V_{TRRI}	$R_{OUT}=100\Omega, T \leq 100ms$	-50	-75		V

■ ELECTRICAL CHARACTERISTICS(Cont.)

For LM2940-10V

PARAMETER	SYMBOL	TEST CONDITIONS	MIN	TYP	MAX	UNIT
Output Voltage	V_{OUT}	$11.5V \leq V_{IN} \leq 26V, 5mA \leq I_{OUT} \leq 1A$	9.70	10.00	10.30	V
Line regulation	ΔV_{OUT}	$V_{OUT} + 2V \leq V_{IN} \leq 26V, I_{OUT} = 5mA$		20	100	mV
Load Regulation	ΔV_{OUT}	$50mA \leq I_{OUT} \leq 1A$		65	100	mV
Output Impedance	R_{OUT}	100mA DC and 20mA _{RMS} , $f_0=120Hz$		65		m Ω
Quiescent Current	I_Q	$V_{OUT} + 2V \leq V_{IN} \leq 26V, I_{OUT} = 5mA$		10	15	mA
Output Noise Voltage	e_N	10Hz-100kHz, $I_{OUT} = 5mA$		300		μV_{RMS}
Ripple Rejection	RR	$f_0=120Hz, 1V_{RMS}, I_{OUT} = 100mA$	51	63		dB
Long Term Stability				36		mV/1000Hr
Dropout Voltage	V_D	$I_{OUT} = 1A$		0.5	0.8	V
		$I_{OUT} = 100mA$		0.13	0.15	
Short Circuit Current	I_{SC}	(Note)		2.5		A
Maximum Line Transient	T_{IN}	$R_{OUT}=100\Omega, T \leq 100ms$	60	75		V
Reverse Polarity DC Input Voltage	V_{RIN}	$R_{OUT}=100\Omega$	-15	-30		V
Reverse Polarity Transient Input Voltage	V_{TRRI}	$R_{OUT}=100\Omega, T \leq 100ms$	-50	-75		V

UTC LM2940-12V

PARAMETER	SYMBOL	TEST CONDITIONS	MIN	TYP	MAX	UNIT
Output Voltage	V_{OUT}	$13.6V \leq V_{IN} \leq 26V, 5mA \leq I_{OUT} \leq 1A$	11.64	12.00	12.36	V
Line regulation	ΔV_{OUT}	$V_{OUT} + 2V \leq V_{IN} \leq 26V, I_{OUT} = 5mA$		20	120	mV
Load Regulation	ΔV_{OUT}	$50mA \leq I_{OUT} \leq 1A$		55	120	mV
Output Impedance	R_{OUT}	100mA DC and 20mA _{RMS} , $f_0=120Hz$		80		m Ω
Quiescent Current	I_Q	$V_{OUT} + 2V \leq V_{IN} \leq 26V, I_{OUT} = 5mA$		10	15	mA
Output Noise Voltage	e_N	10Hz-100kHz, $I_{OUT} = 5mA$		360		μV_{RMS}
Ripple Rejection	RR	$f_0=120Hz, 1V_{RMS}, I_{OUT} = 100mA$	54	66		dB
Long Term Stability				48		mV/1000Hr
Dropout Voltage	V_D	$I_{OUT} = 1A$		0.5	0.8	V
		$I_{OUT} = 100mA$		0.11	0.15	
Short Circuit Current	I_{SC}	(Note)		2.5		A
Maximum Line Transient	T_{IN}	$R_{OUT}=100\Omega, T \leq 100ms$	60	75		V
Reverse Polarity DC Input Voltage	V_{RIN}	$R_{OUT}=100\Omega$	-15	-30		V
Reverse Polarity Transient Input Voltage	V_{TRRI}	$R_{OUT}=100\Omega, T \leq 100ms$	-50	-75		V

■ ELECTRICAL CHARACTERISTICS(Cont.)

UTC LM2940-15V

PARAMETER	SYMBOL	TEST CONDITIONS	MIN	TYP	MAX	UNIT
Output Voltage	V_{OUT}	$16.75V \leq V_{IN} \leq 26V, 5mA \leq I_{OUT} \leq 1A$	14.55	15.00	15.45	V
Line regulation	ΔV_{OUT}	$V_{OUT} + 2V \leq V_{IN} \leq 26V, I_{OUT} = 5mA$		20	150	mV
Load Regulation	ΔV_{OUT}	$50mA \leq I_{OUT} \leq 1A$		70	150	mV
Output Impedance	R_{OUT}	100mA DC and 20mA _{RMS} , $f_o=120Hz$		100		m Ω
Quiescent Current	I_Q	$V_{OUT} + 2V \leq V_{IN} \leq 26V, I_{OUT} = 5mA$		10	15	mA
Output Noise Voltage	e_N	10Hz-100kHz, $I_{OUT} = 5mA$		450		μV_{RMS}
Ripple Rejection	RR	$f_o=120Hz, 1V_{RMS}, I_{OUT} = 100mA$	52	64		dB
Long Term Stability				60		mV/1000Hr
Dropout Voltage	V_D	$I_{OUT} = 1A$		0.5	0.8	V
		$I_{OUT} = 100mA$		0.11	0.15	
Short Circuit Current	I_{SC}	(Note)		2.5		A
Maximum Line Transient	T_{IN}	$R_{OUT}=100\Omega, T \leq 100ms$	60	75		V
Reverse Polarity DC Input Voltage	V_{RIN}	$R_{OUT}=100\Omega$	-15	-30		V
Reverse Polarity Transient Input Voltage	V_{TRRI}	$R_{OUT}=100\Omega, T \leq 100ms$	-50	-75		V

Note: Output current will decrease with temperature increase but will not drop below 1A at the maximum specified temperature.

■ TYPICAL APPLICATION

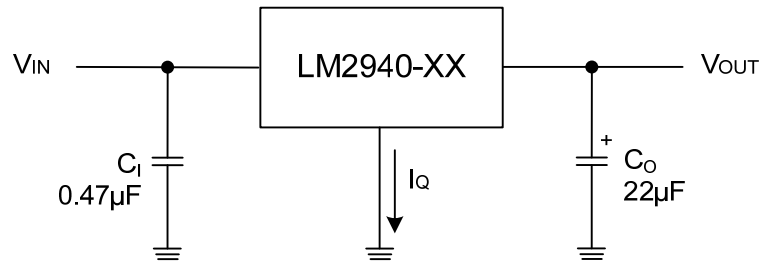

- Note: 1. C_1 is required if regulator is located far from power supply filter.
2. C_0 must be higher than $22\mu\text{F}$ for stability, and locate as close as possible to the regulator.

TYPICAL CHARACTERISTICS

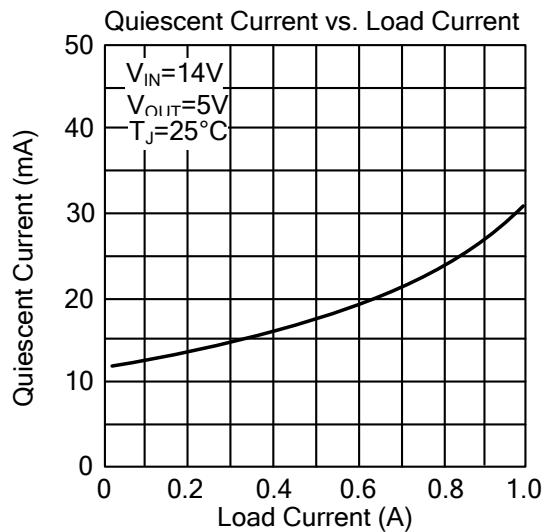
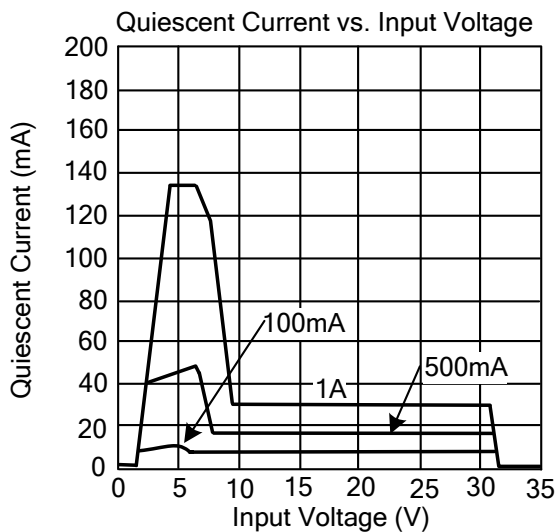
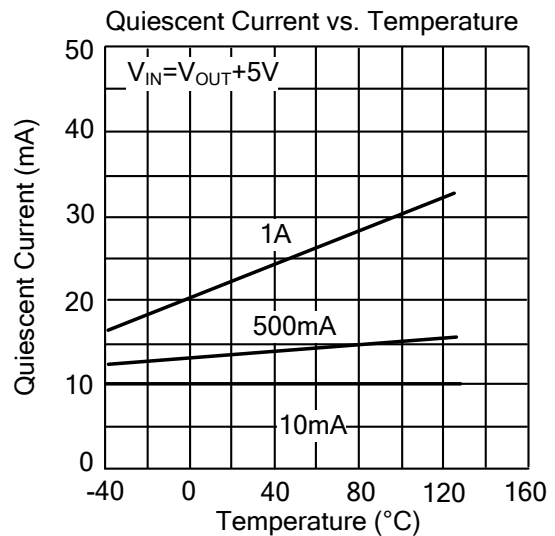
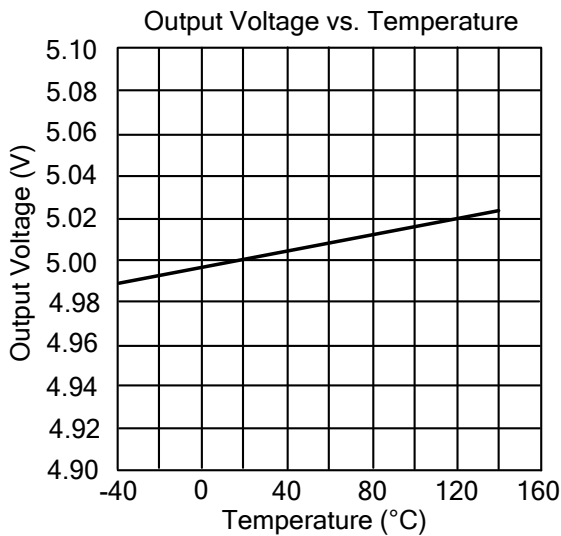
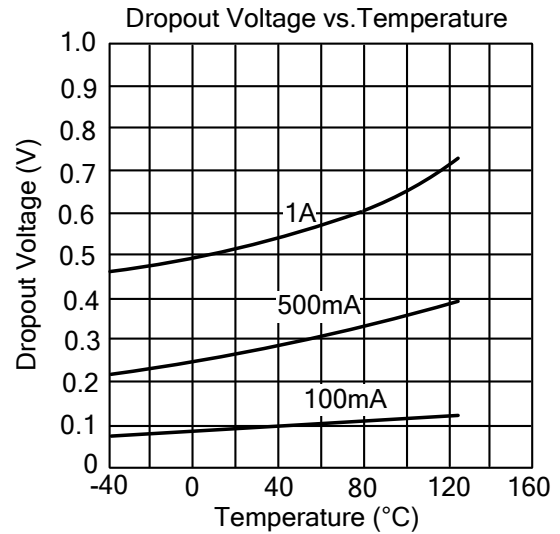
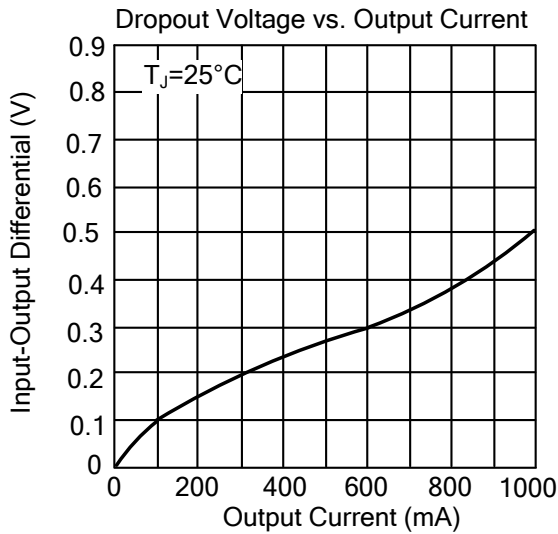

■ TYPICAL CHARACTERISTICS (Cont.)

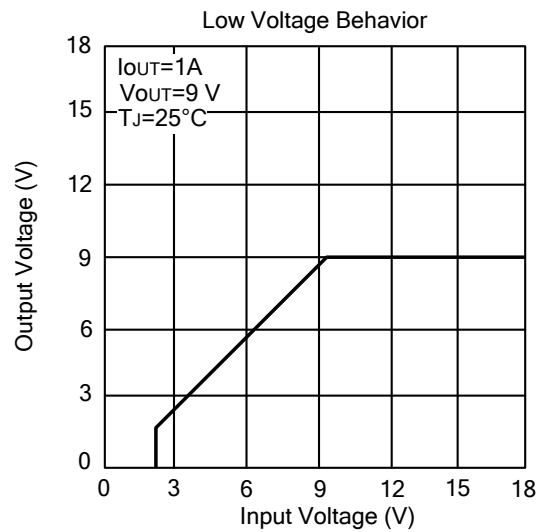
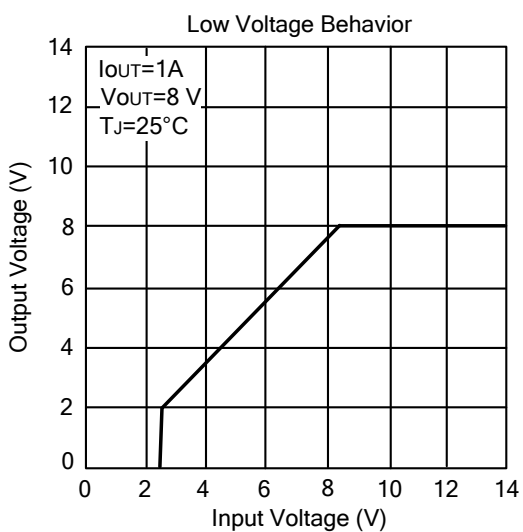
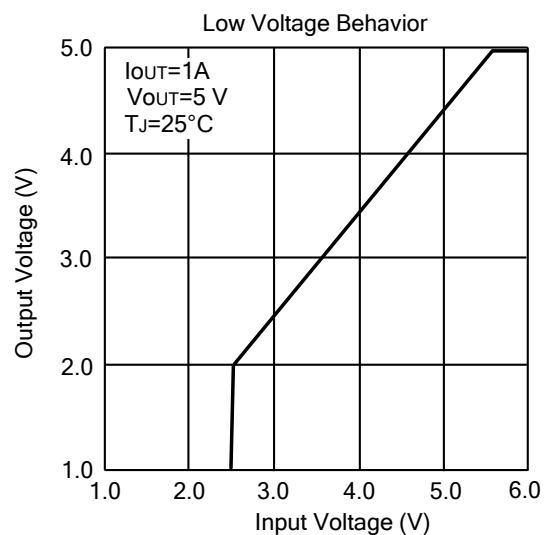
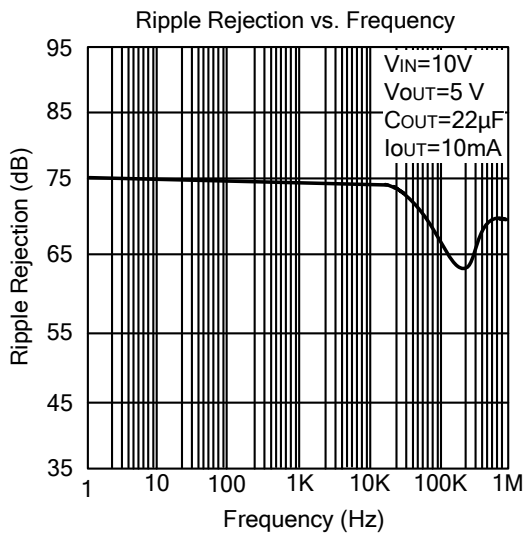
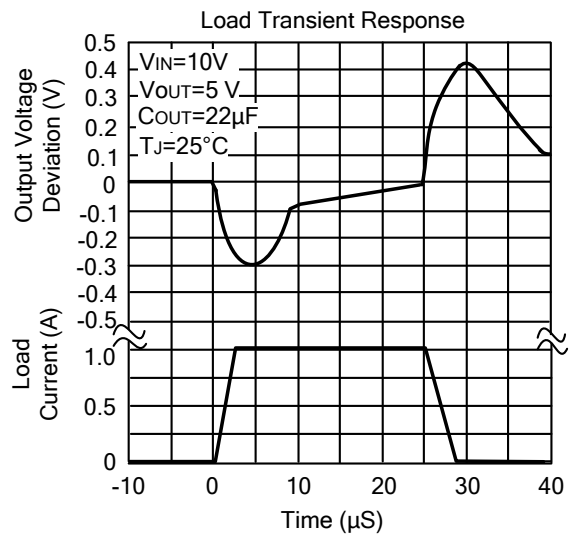
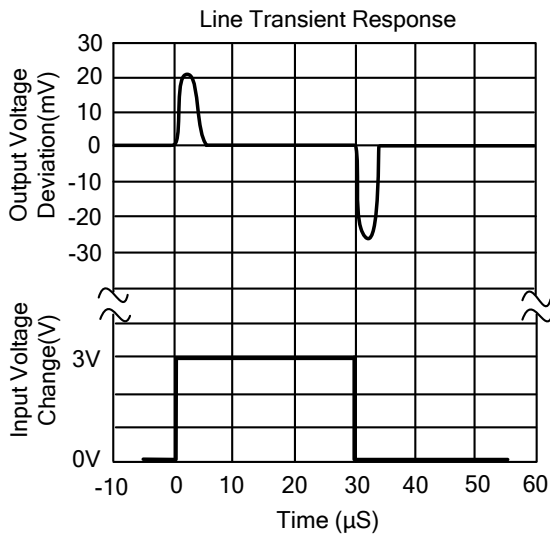

■ TYPICAL CHARACTERISTICS (Cont.)

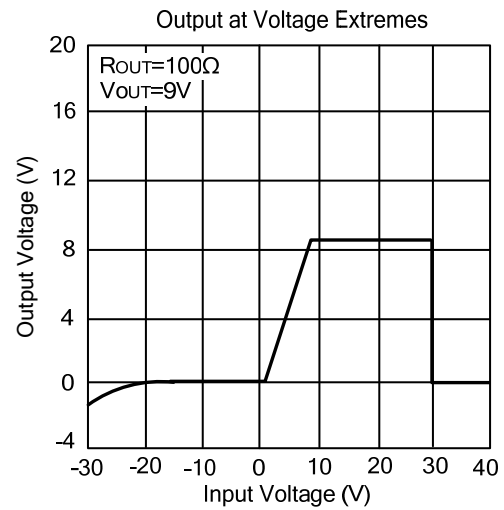
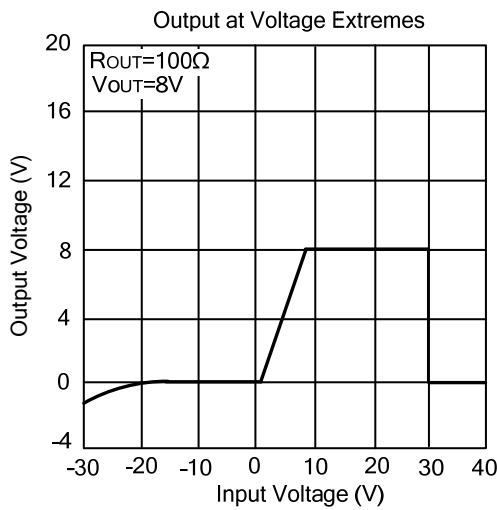
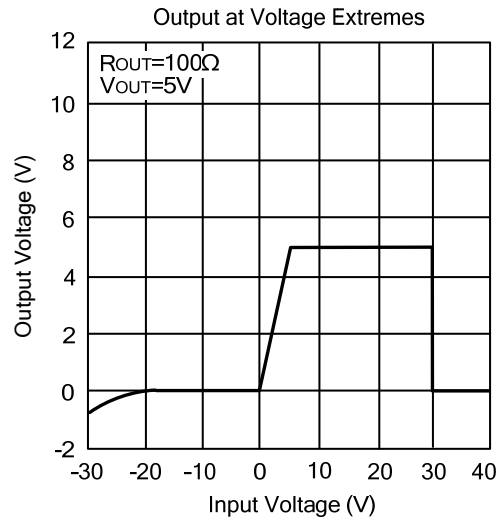
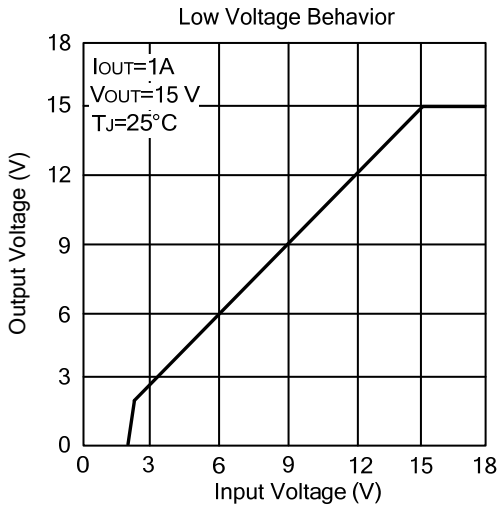
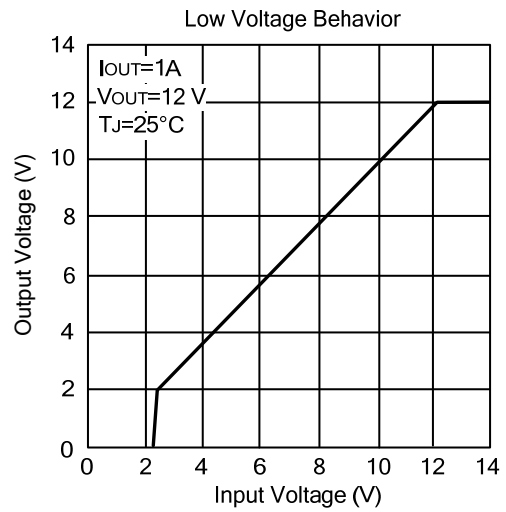
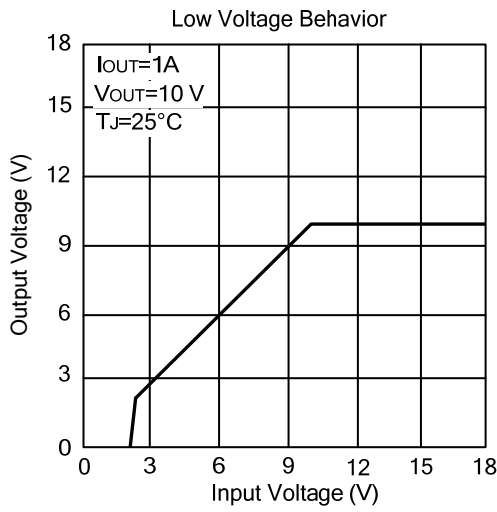

■ TYPICAL CHARACTERISTICS (Cont.)

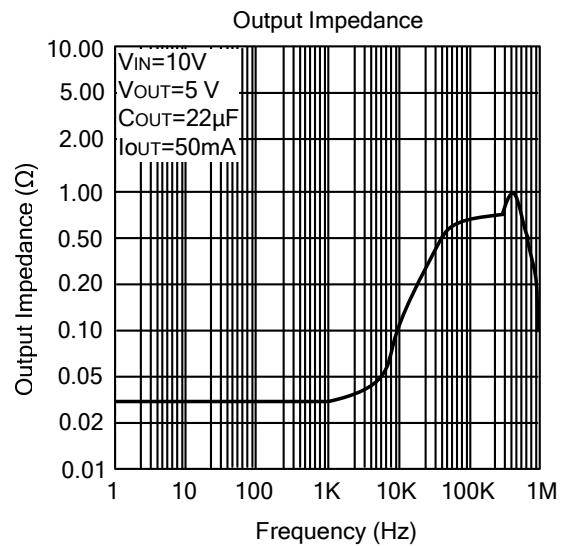
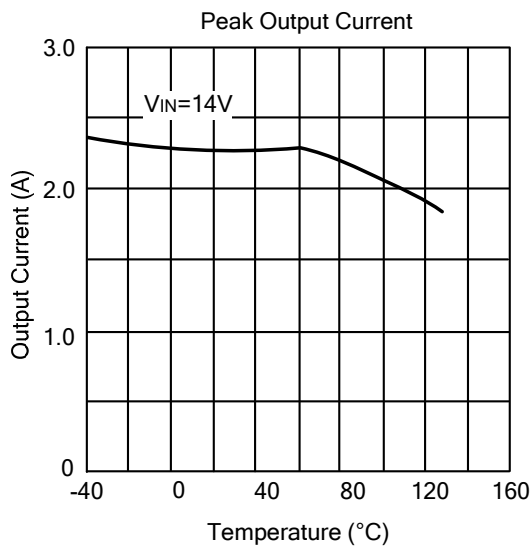
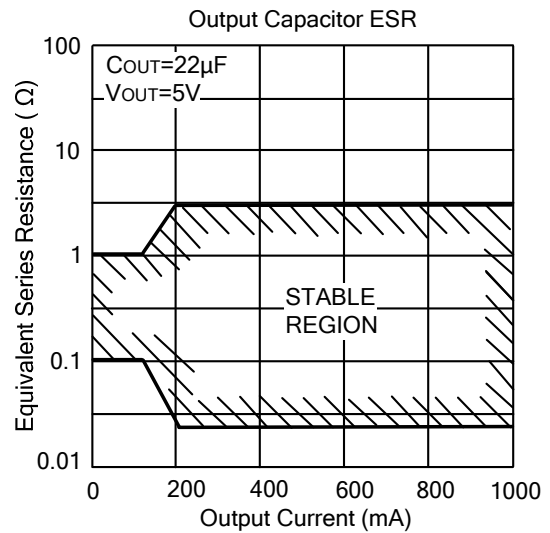
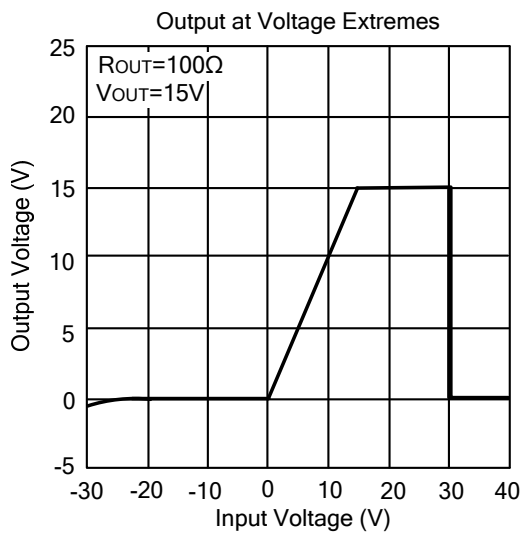
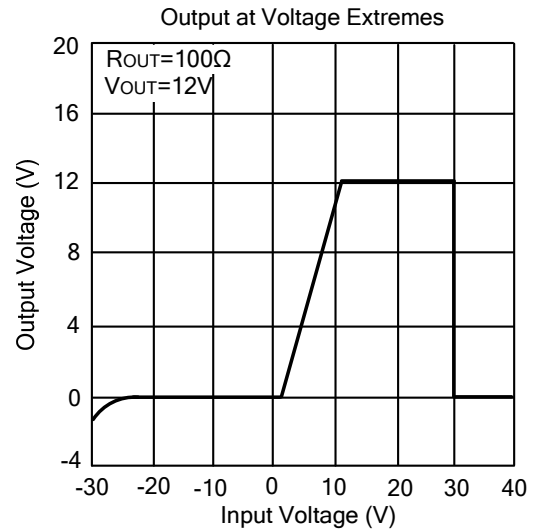
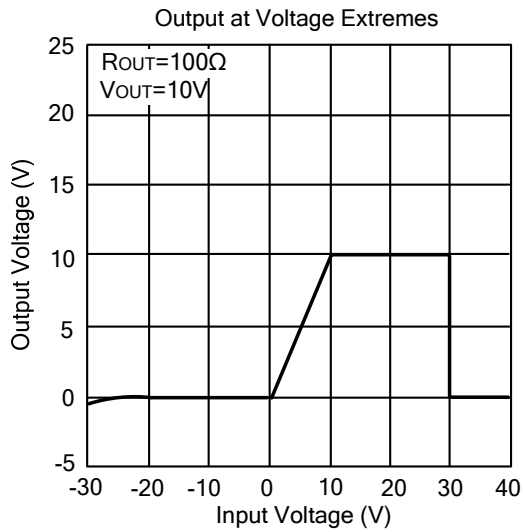

■ TYPICAL CHARACTERISTICS (Cont.)

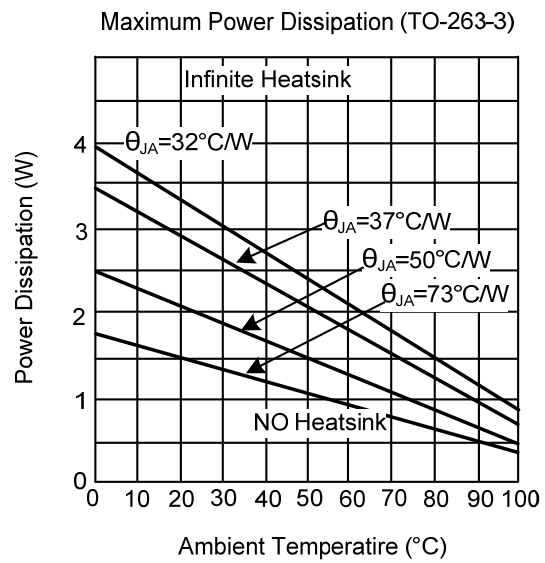
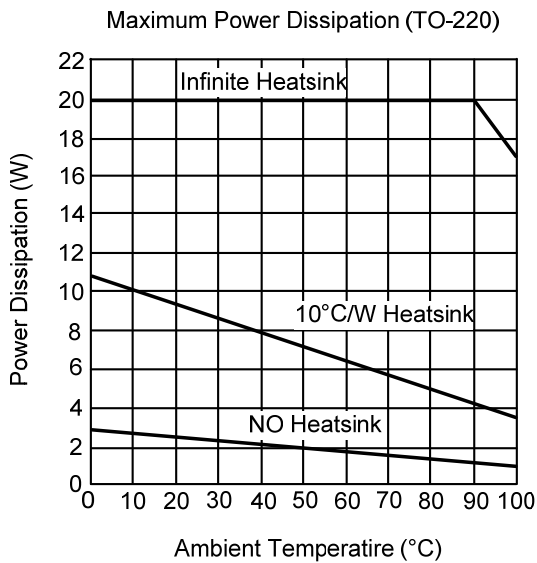

UTC assumes no responsibility for equipment failures that result from using products at values that exceed, even momentarily, rated values (such as maximum ratings, operating condition ranges, or other parameters) listed in products specifications of any and all UTC products described or contained herein. UTC products are not designed for use in life support appliances, devices or systems where malfunction of these products can be reasonably expected to result in personal injury. Reproduction in whole or in part is prohibited without the prior written consent of the copyright owner. The information presented in this document does not form part of any quotation or contract, is believed to be accurate and reliable and may be changed without notice.

单击下面可查看定价，库存，交付和生命周期等信息

[>>UTC\(友顺\)](#)