

THIS DRAWING IS UNPUBLISHED. RELEASED FOR PUBLICATION 2018  
 © COPYRIGHT 2018 BY - ALL RIGHTS RESERVED.

REVISIONS					
P	LTR	DESCRIPTION	DATE	DWN	APVD
	B	LOGO CHANGE; RESIN MARK ADD	08AUG2018	F.Z	R.B

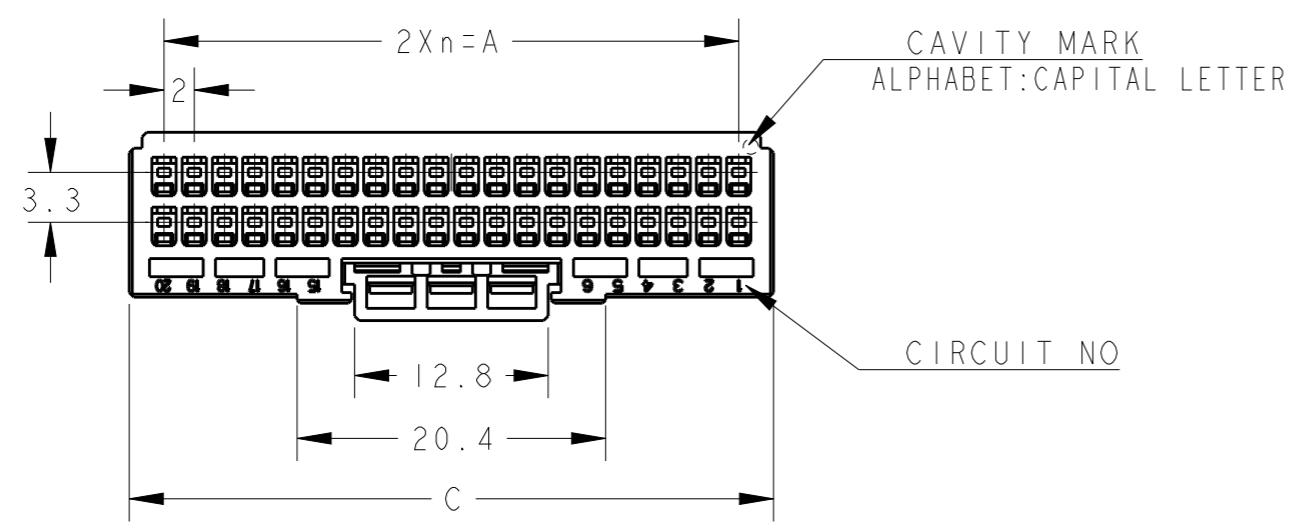

1. MATERIAL: GLASS FILED THERMO PLASTIC POLYESTER(94V-0), COLOR: BLACK
2. THE SHAPE, SIZE AND POSITION OF THE CHARACTER SHOW THE OUTLINE. THEY DON'T SHOW DETAILS.
3. THE KEYING ARRANGEMENT OF "Y" IS SYMMETRIC WITH "X".

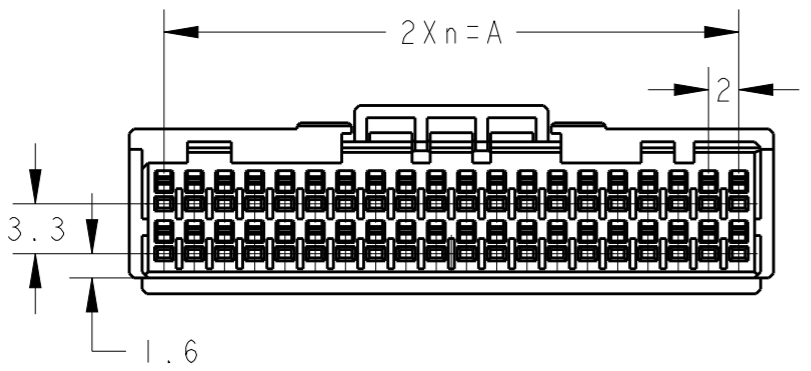
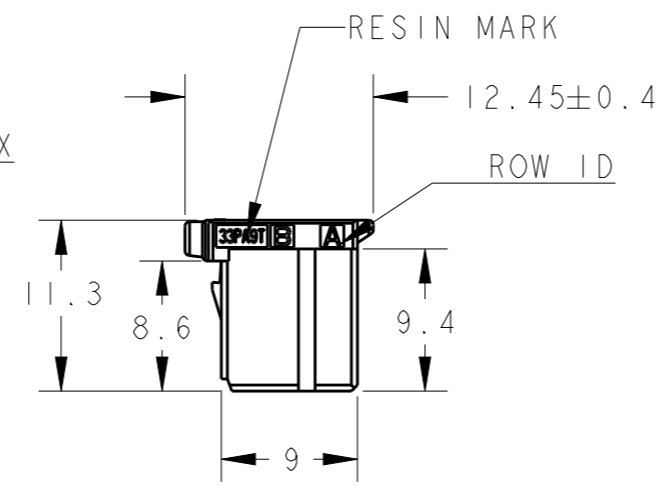
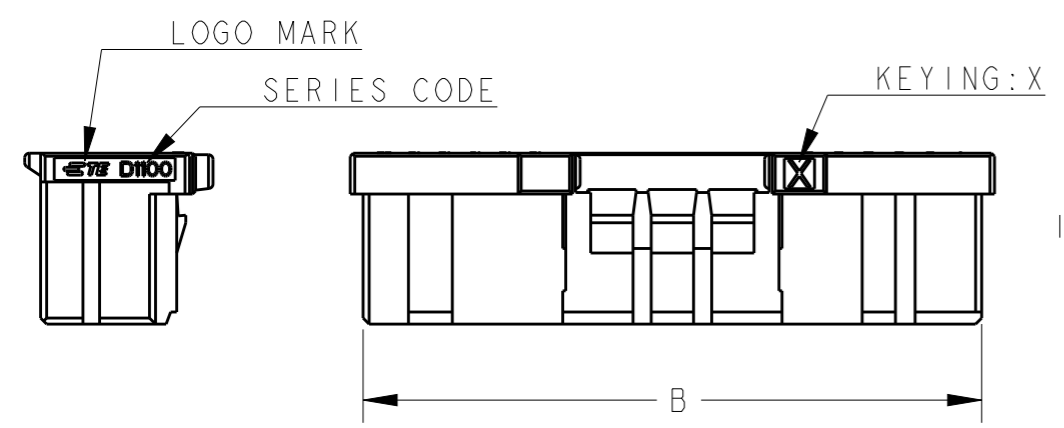

40	Y	19	38.0	40.9	42.6	2-2333134-0
40	X	19	38.0	40.9	42.6	1-2333134-0
34	Y	16	32.0	34.9	36.6	2-2333134-7
34	X	16	32.0	34.9	36.6	1-2333134-7
32	X	15	30.0	32.9	34.6	1-2333134-6
30	X	14	28.0	30.9	32.6	1-2333134-5
28	X	13	26.0	28.9	30.6	1-2333134-4
26	Y	12	24.0	26.9	28.6	2-2333134-3
26	X	12	24.0	26.9	28.6	1-2333134-3
24	X	11	22.0	24.9	26.6	1-2333134-2
22	X	10	20.0	22.9	24.6	1-2333134-1
POS	KEY	n	A	B	C	PART NO

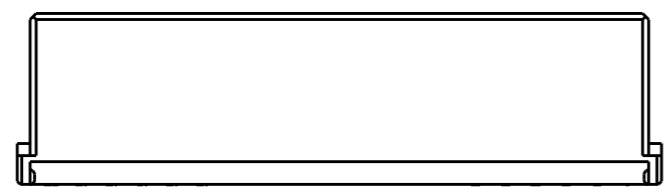

40POS(X-KEY): 1-2333134-0

THIS DRAWING IS A CONTROLLED DOCUMENT.		DWN Fisher ZHU 09-Aug-18	TE Connectivity NAME DYNAMIC D1100D 2.0mm PITCH REC HSG 22-40POS					
DIMENSIONS: mm		CHK Rick BIAN 09-Aug-18						
TOLERANCES UNLESS OTHERWISE SPECIFIED: ±0.3, ±5°		APVD Rick BIAN 09-Aug-18						
0 PLC ± 1 PLC ±0.3 2 PLC ±0.10 3 PLC ±0.001 4 PLC ±0.0001 ANGLES ±		PRODUCT SPEC 108-78268, 78298						
MATERIAL		FINISH	APPLICATION SPEC 114-5377	WEIGHT	SIZE A3	CAGE CODE 00779	DRAWING NO C-2333134	RESTRICTED TO
CUSTOMER DRAWING			SCALE 2:1	SHEET 1 OF 3	REV B			

REVISIONS

P	LTR	DESCRIPTION	DATE	DWN	APVD
		SEE SHEET 1			

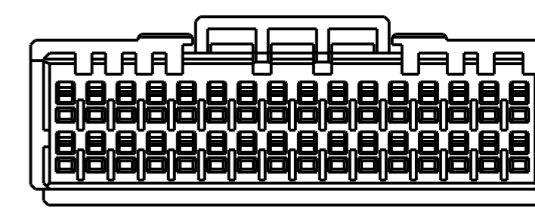
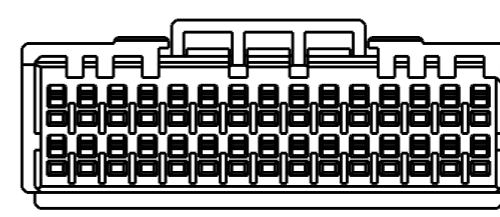
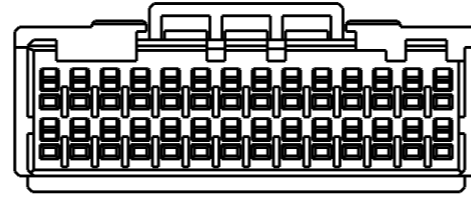
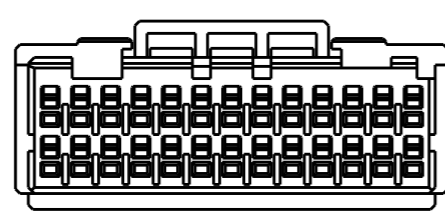
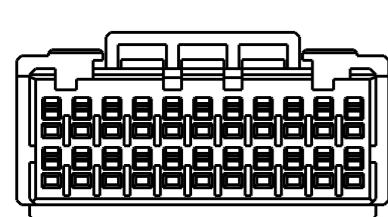
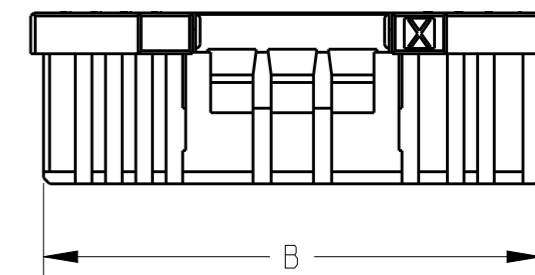
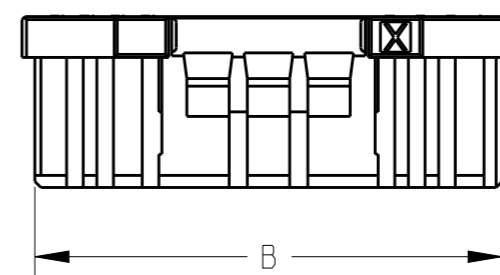
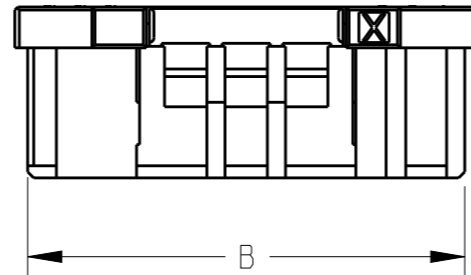
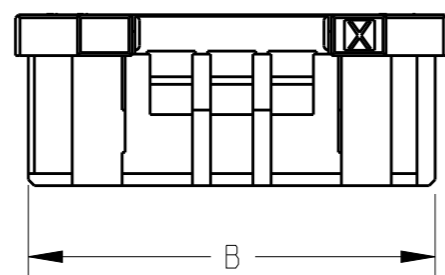
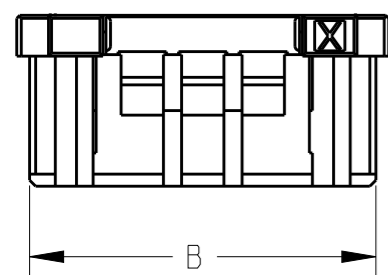
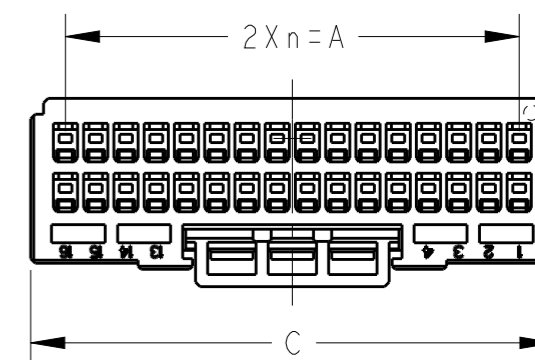
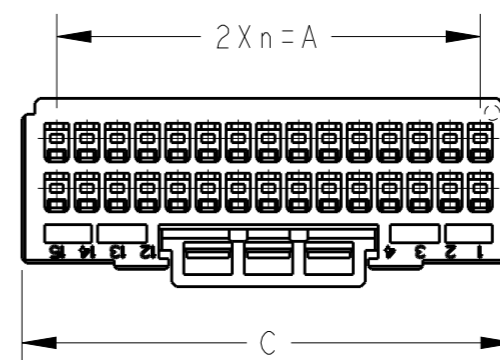
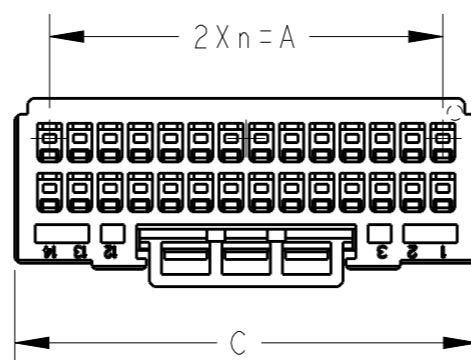
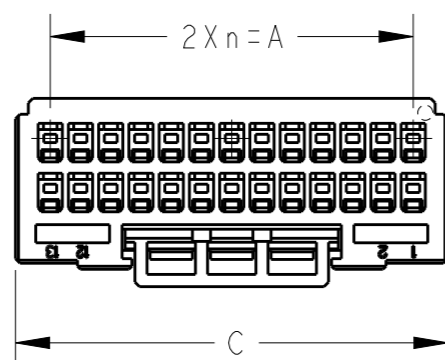
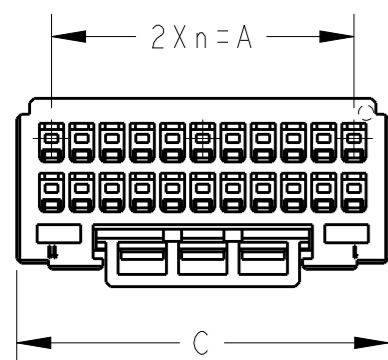

22POS(X-KEY): I-2333134-1

26POS(X-KEY): I-2333134-3

28POS(X-KEY): I-2333134-4

30POS(X-KEY): I-2333134-5

32POS(X-KEY): I-2333134-6

THIS DRAWING IS A CONTROLLED DOCUMENT.

DIMENSIONS:  
mm



TOLERANCES UNLESS OTHERWISE SPECIFIED:

- 0 PLC ±
- 1 PLC ±
- 2 PLC ±
- 3 PLC ±
- 4 PLC ±
- ANGLES ±
- FINISH -

MATERIAL

FINISH

DWN 09-Aug-18

Fisher ZHU

CHK 09-Aug-18

Rick BIAN

APVD 09-Aug-18

Rick BIAN

PRODUCT SPEC

108-78268,78298

APPLICATION SPEC

114-5377

WEIGHT

-

CUSTOMER DRAWING



TE Connectivity

NAME  
DYNAMIC D1100D 2.0mm PITCH  
REC HSG  
22-40POS

SIZE CAGE CODE DRAWING NO RESTRICTED TO

A300779 C-2333134 -

SCALE 2:1 SHEET 2 OF 3 REV B

SEE SHEET 1 OF 3

THIS DRAWING IS UNPUBLISHED. RELEASED FOR PUBLICATION 2018  
© COPYRIGHT 2018 BY - ALL RIGHTS RESERVED.

REVISIONS

P	LTR	DESCRIPTION	DATE	DWN	APVD
		SEE SHEET 1			

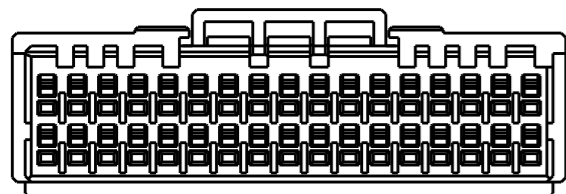
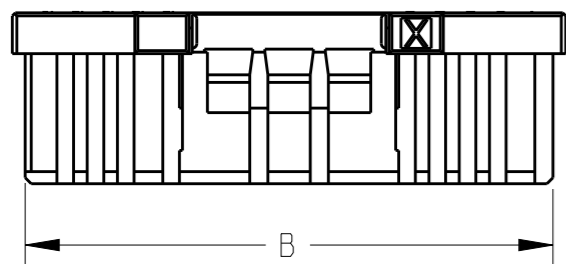
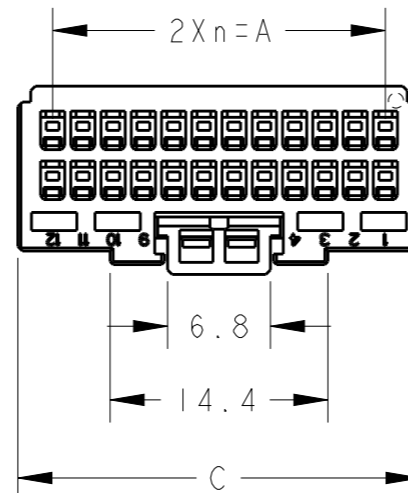
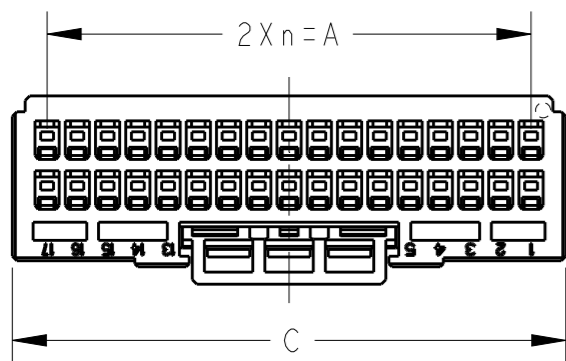

34POS(X-KEY): 1-2333134-7

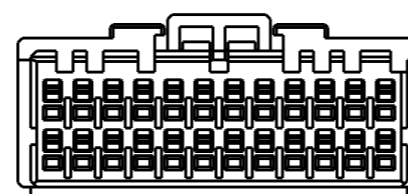
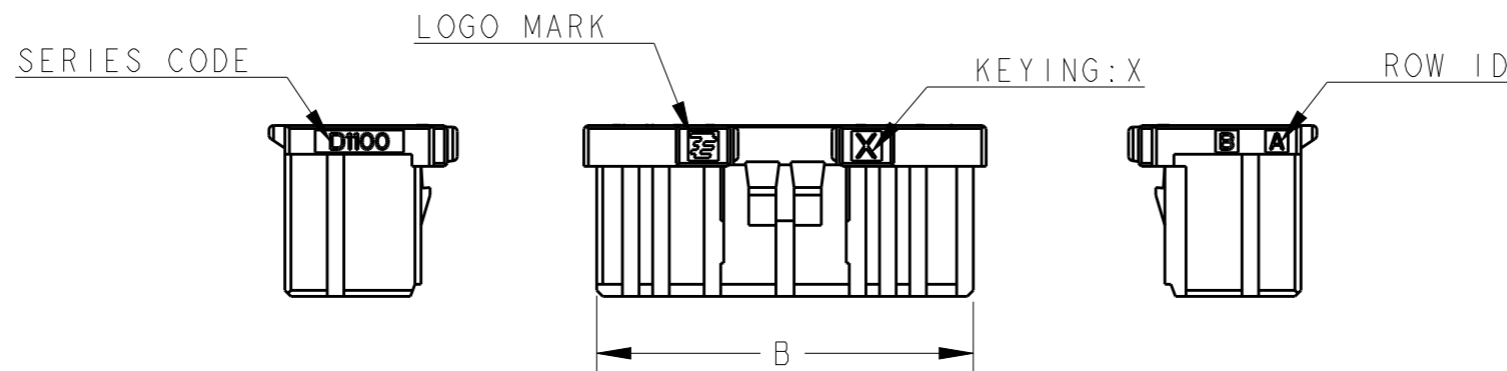

24POS(X-KEY): 1-2333134-2

THIS DRAWING IS A CONTROLLED DOCUMENT.		DWN Fisher ZHU 09-Aug-18	 TE Connectivity				
DIMENSIONS: mm		CHK Rick BIAN 09-Aug-18			NAME DYNAMIC D1100D 2.0mmPITCH REC HSG 22-40POS		
TOLERANCES UNLESS OTHERWISE SPECIFIED:		APVD Rick BIAN 09-Aug-18					
0 PLC ± 1 PLC ± 2 PLC ± 3 PLC ± 4 PLC ± ANGLES ±		PRODUCT SPEC 108-78268,78298	SIZE A3	CAGE CODE 00779	DRAWING NO C-2333134	RESTRICTED TO -	
MATERIAL -		FINISH -	APPLICATION SPEC 114-5377	SCALE 2:1		SHEET 3 OF 3	REV B
CUSTOMER DRAWING							

SEE SHEET 1 OF 3

单击下面可查看定价，库存，交付和生命周期等信息

[>>TE Connectivity\(泰科\)](#)