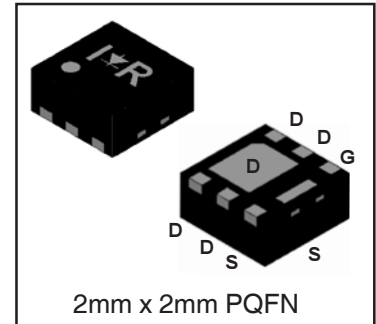
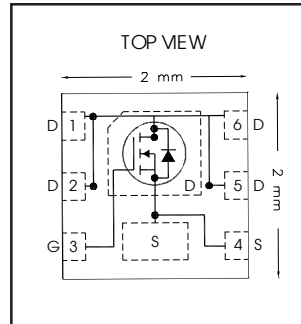


HEXFET® Power MOSFET

V_{DS}	25	V
$V_{GS\ max}$	±20	V
$R_{DS(on)\ max}$ (@ $V_{GS} = 10V$)	13.0	mΩ
Q_g (typical) (@ $V_{GS} = 4.5V$)	4.3	nC
I_D (@ $T_{c(Bottom)} = 25°C$)	8.5 ②	A



Applications

- System/Load Switch

Features and Benefits

Features

Low $R_{DS(on)}$ ($\leq 13.0m\Omega$)
Low Thermal Resistance to PCB ($\leq 13°C/W$)
Low Profile ($\leq 1.0\ mm$)
Compatible with Existing Surface Mount Techniques
RoHS Compliant Containing no Lead, no Bromide and no Halogen
MSL1, Industrial Qualification

Resulting Benefits

Lower Conduction Losses
Enable better thermal dissipation
Increased Power Density
Easier Manufacturing
Environmentally Friendlier
Increased Reliability

results in

Orderable part number	Package Type	Standard Pack		Note
		Form	Quantity	
IRFHS8242TRPbF	PQFN 2mm x 2mm	Tape and Reel	4000	
IRFHS8242TR2PbF	PQFN 2mm x 2mm	Tape and Reel	400	EOL notice # 259

Absolute Maximum Ratings

	Parameter	Max.	Units
V_{DS}	Drain-to-Source Voltage	25	V
V_{GS}	Gate-to-Source Voltage	±20	
$I_D @ T_A = 25°C$	Continuous Drain Current, $V_{GS} @ 10V$	9.9②	A
$I_D @ T_A = 70°C$	Continuous Drain Current, $V_{GS} @ 10V$	8.0	
$I_D @ T_{C(Bottom)} = 25°C$	Continuous Drain Current, $V_{GS} @ 10V$	21②	
$I_D @ T_{C(Bottom)} = 70°C$	Continuous Drain Current, $V_{GS} @ 10V$	17②	
$I_D @ T_{C(Bottom)} = 25°C$	Continuous Drain Current, $V_{GS} @ 10V$ (Package Limited)	8.5②	
I_{DM}	Pulsed Drain Current ①	84	
$P_D @ T_A = 25°C$	Power Dissipation ④	2.1	W
$P_D @ T_A = 70°C$	Power Dissipation ④	1.3	
	Linear Derating Factor ④	0.02	W/°C
T_J	Operating Junction and	-55 to + 150	°C
T_{STG}	Storage Temperature Range		

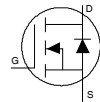
Notes ① through ⑥ are on page 2

Static @ T_J = 25°C (unless otherwise specified)

	Parameter	Min.	Typ.	Max.	Units	Conditions
BV _{DSS}	Drain-to-Source Breakdown Voltage	25	—	—	V	V _{GS} = 0V, I _D = 250μA
ΔBV _{DSS} /ΔT _J	Breakdown Voltage Temp. Coefficient	—	18	—	mV/°C	Reference to 25°C, I _D = 1mA
R _{DS(on)}	Static Drain-to-Source On-Resistance	—	10.0	13.0	mΩ	V _{GS} = 10V, I _D = 8.5A ③②
		—	17.0	21.0		V _{GS} = 4.5V, I _D = 6.8A ③
V _{GS(th)}	Gate Threshold Voltage	1.35	1.8	2.35	V	V _{DS} = V _{GS} , I _D = 25μA
ΔV _{GS(th)}	Gate Threshold Voltage Coefficient	—	-6.8	—	mV/°C	
I _{DSS}	Drain-to-Source Leakage Current	—	—	1.0	μA	V _{DS} = 20V, V _{GS} = 0V
		—	—	150		V _{DS} = 20V, V _{GS} = 0V, T _J = 125°C
I _{GSS}	Gate-to-Source Forward Leakage	—	—	100	nA	V _{GS} = 20V
	Gate-to-Source Reverse Leakage	—	—	-100		V _{GS} = -20V
g _{fs}	Forward Transconductance	19	—	—	S	V _{DS} = 10V, I _D = 8.5A②
Q _g	Total Gate Charge ⑥	—	4.3	—	nC	V _{GS} = 4.5V, V _{DS} = 13V, I _D = 8.5A②
Q _g	Total Gate Charge ⑥	—	10.4	—	nC	V _{DS} = 13V
Q _{gs}	Gate-to-Source Charge ⑥	—	1.8	—		V _{GS} = 10V
Q _{gd}	Gate-to-Drain Charge ⑥	—	1.6	—		I _D = 8.5A② (See Fig. 6 & 16)
R _G	Gate Resistance	—	1.9	—	Ω	
t _{d(on)}	Turn-On Delay Time	—	6.5	—	ns	V _{DD} = 13V, V _{GS} = 4.5V③
t _r	Rise Time	—	19	—		I _D = 8.5A②
t _{d(off)}	Turn-Off Delay Time	—	5.4	—		R _G = 1.8Ω
t _f	Fall Time	—	5.3	—		See Fig.17
C _{iss}	Input Capacitance	—	653	—	pF	V _{GS} = 0V
C _{oss}	Output Capacitance	—	171	—		V _{DS} = 10V
C _{rss}	Reverse Transfer Capacitance	—	78	—		f = 1.0MHz

Diode Characteristics

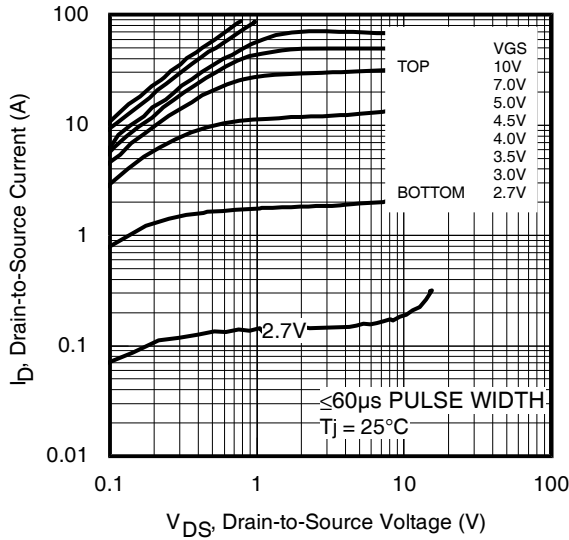
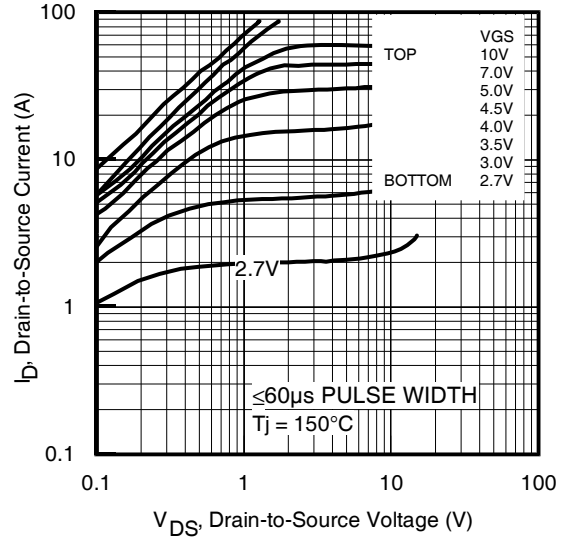
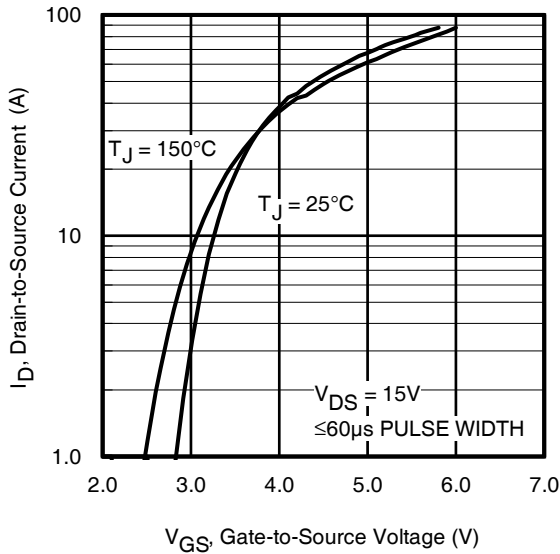
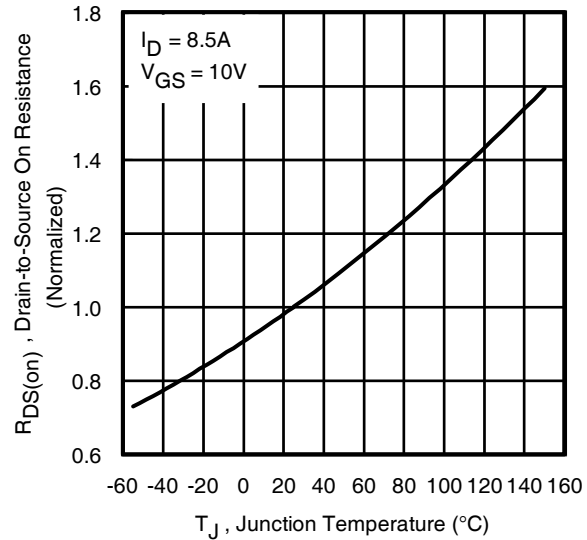
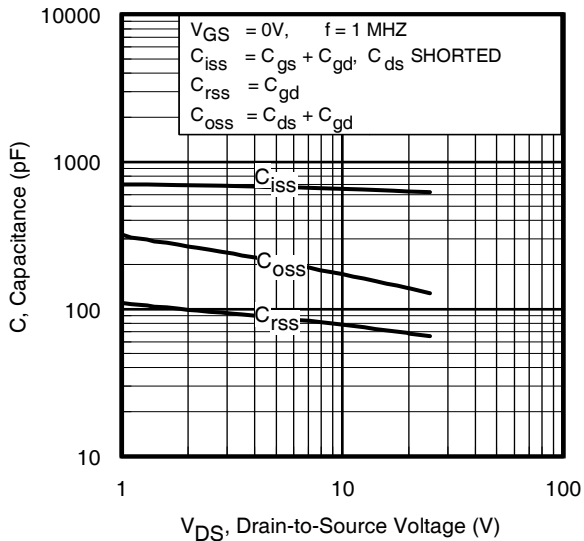
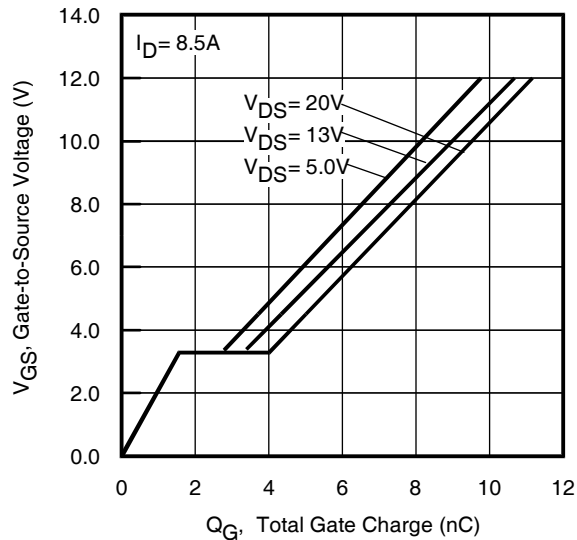
	Parameter	Min.	Typ.	Max.	Units	Conditions
I _S	Continuous Source Current (Body Diode)	—	—	8.5②	A	MOSFET symbol showing the integral reverse p-n junction diode.
I _{SM}	Pulsed Source Current (Body Diode) ①	—	—	84		
V _{SD}	Diode Forward Voltage	—	—	1.0	V	T _J = 25°C, I _S = 8.5A②, V _{GS} = 0V ③
t _{rr}	Reverse Recovery Time	—	11	17	ns	T _J = 25°C, I _F = 8.5A②, V _{DD} = 13V
Q _{rr}	Reverse Recovery Charge	—	11	17	nC	di/dt = 280 A/μs ③
t _{on}	Forward Turn-On Time	Time is dominated by parasitic Inductance				

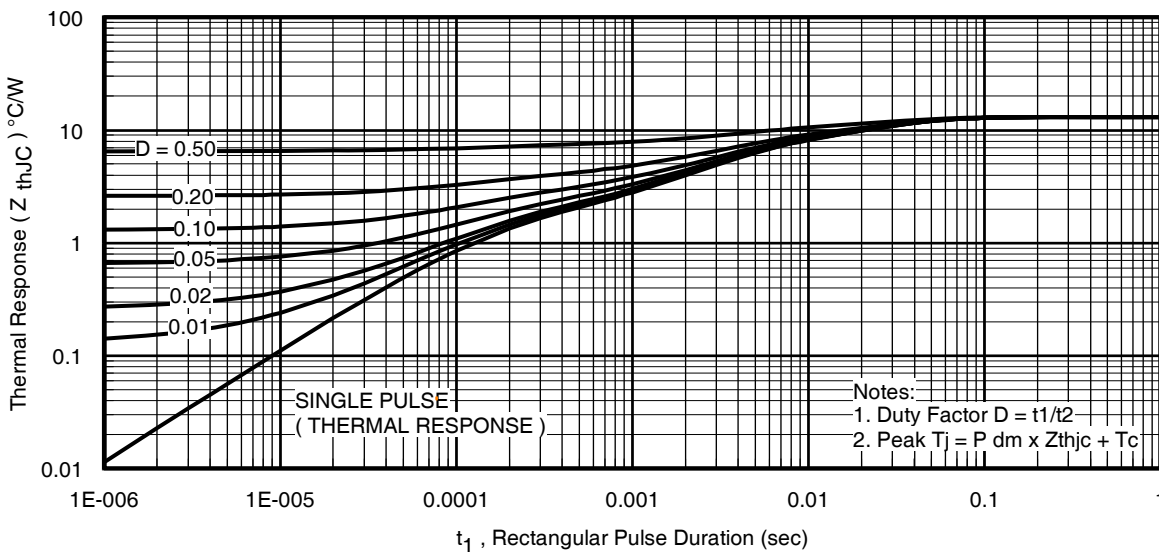
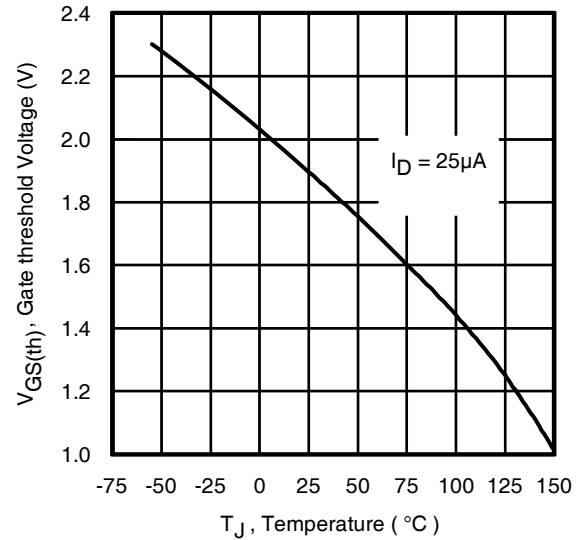
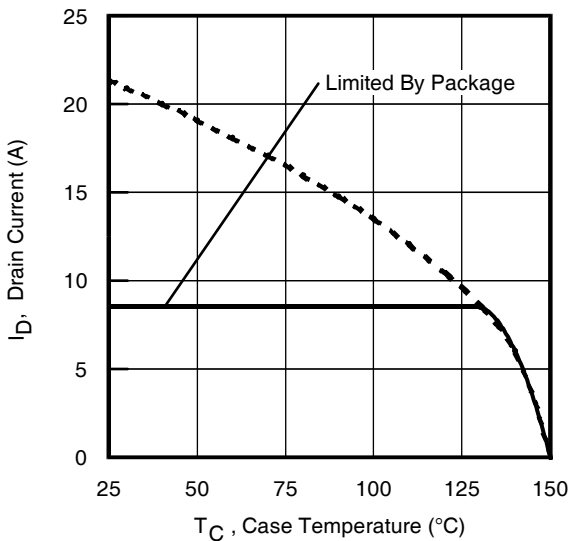
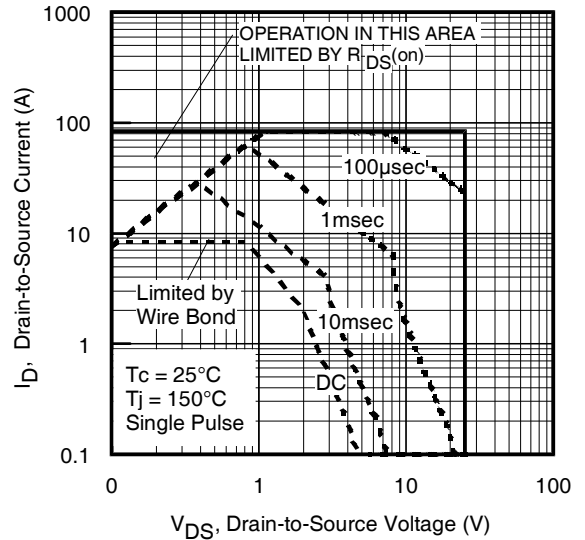
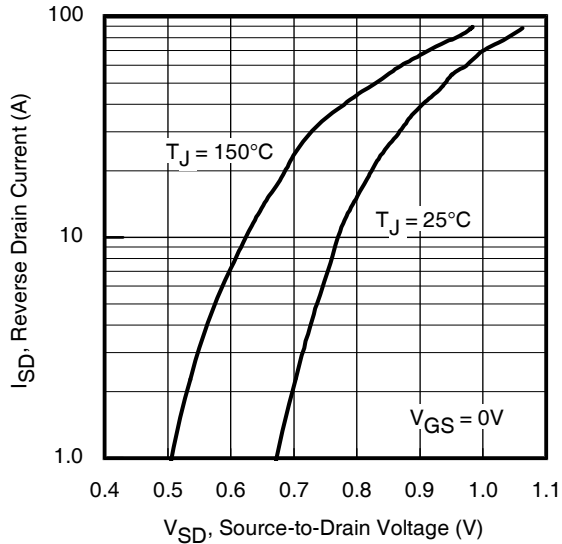

Thermal Resistance

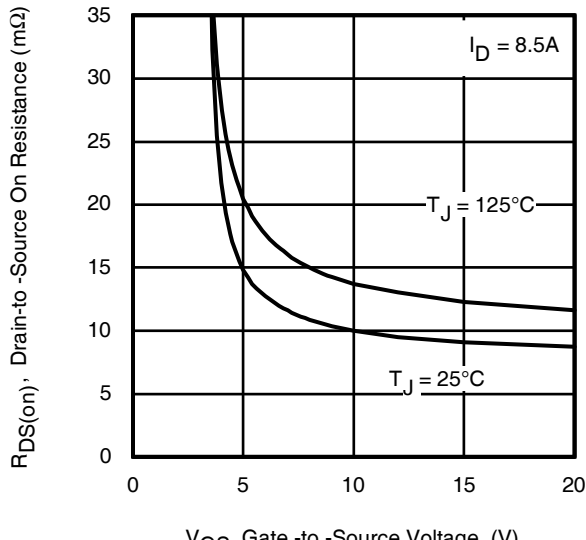
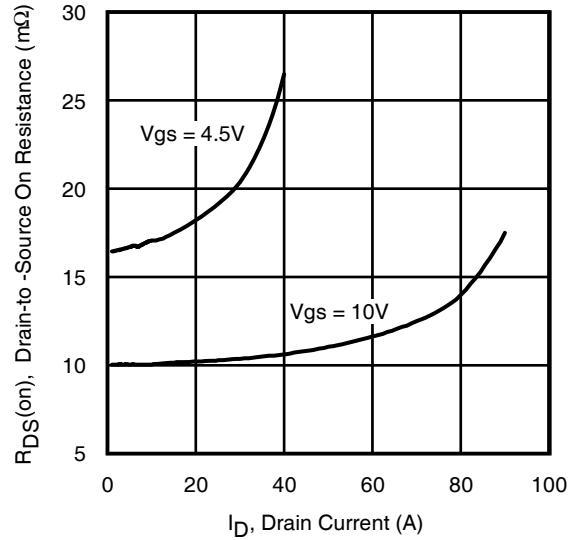
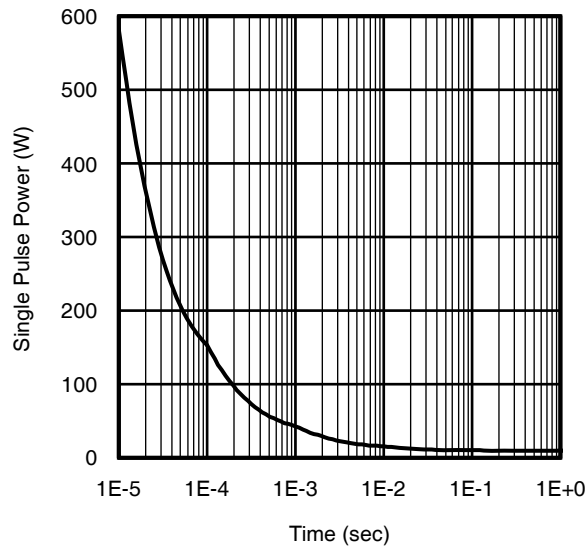
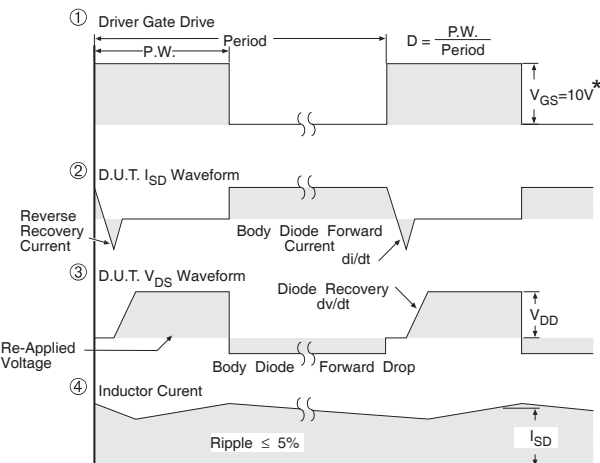
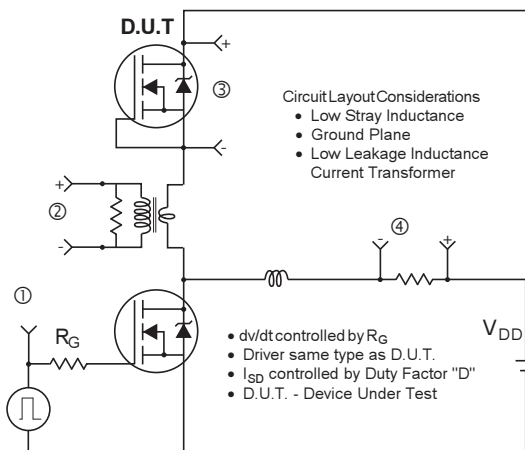
	Parameter	Typ.	Max.	Units
R _{θJC} (Bottom)	Junction-to-Case ⑤	—	13	°C/W
R _{θJC} (Top)	Junction-to-Case ⑤	—	90	
R _{θJA}	Junction-to-Ambient ④	—	60	
R _{θJA}	Junction-to-Ambient (<10s) ④	—	42	

Notes:

- ① Repetitive rating; pulse width limited by max. junction temperature.
- ② Current limited by package.
- ③ Pulse width ≤ 400μs; duty cycle ≤ 2%.
- ④ When mounted on 1 inch square copper board
- ⑤ R_θ is measured at T_J of approximately 90°C.
- ⑥ For DESIGN AID ONLY, not subject to production testing.

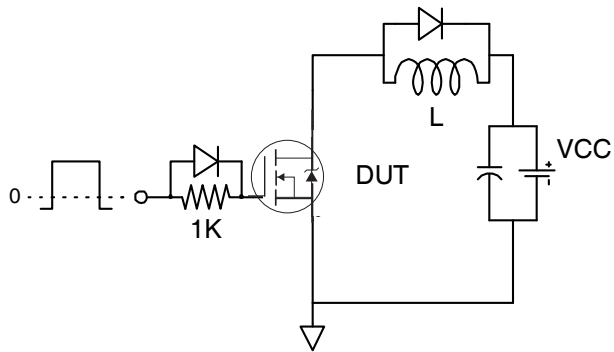
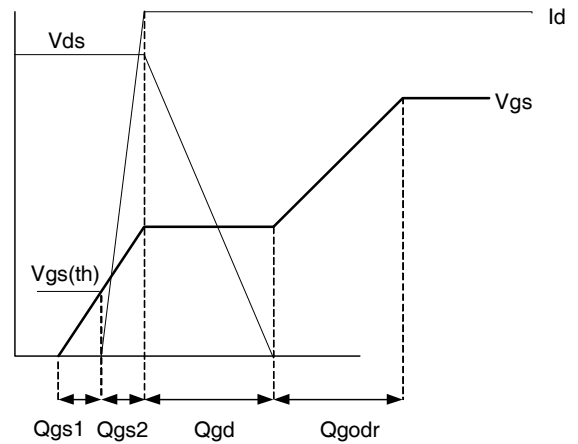
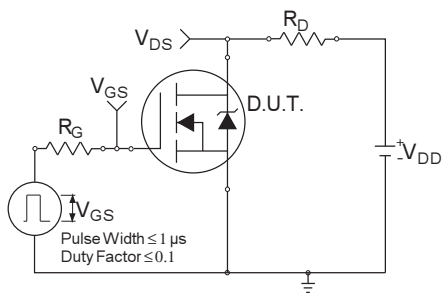
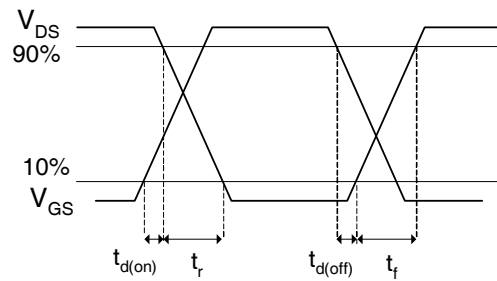

Fig 1. Typical Output Characteristics

Fig 2. Typical Output Characteristics

Fig 3. Typical Transfer Characteristics

Fig 4. Normalized On-Resistance vs. Temperature

Fig 5. Typical Capacitance vs. Drain-to-Source Voltage

Fig 6. Typical Gate Charge vs. Gate-to-Source Voltage



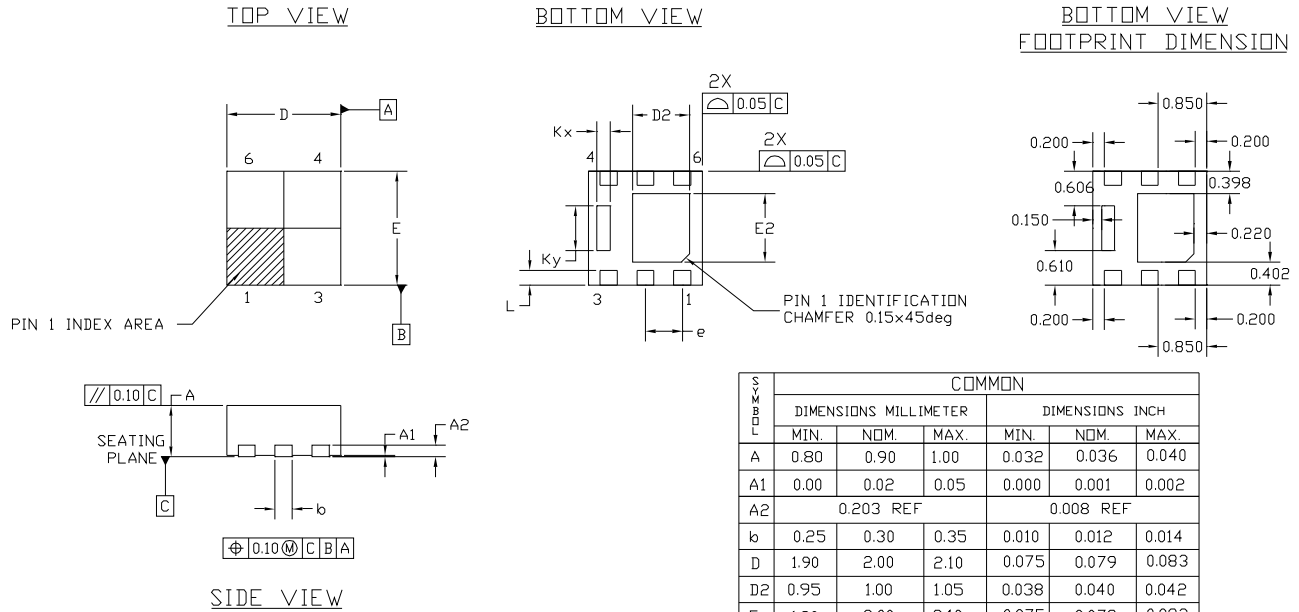

Fig 12. On-Resistance vs. Gate Voltage

Fig 13. Typical On-Resistance vs. Drain Current

Fig 14. Typical Power vs. Time


* $V_{GS} = 5V$ for Logic Level Devices

Fig 15. Peak Diode Recovery dv/dt Test Circuit for N-Channel HEXFET[®] Power MOSFETs


Fig 16a. Gate Charge Test Circuit

Fig 16b. Gate Charge Waveform

Fig 17a. Switching Time Test Circuit

Fig 17b. Switching Time Waveforms

PQFN 2x2 Outline Package Details

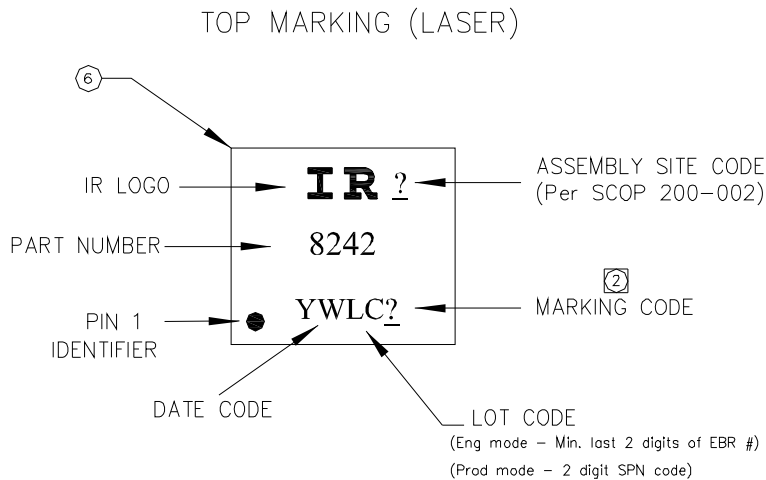


NOTES :

1. DIMENSION AND TOLERANCING CONFORM TO ASME Y14.5M-1994.
2. CONTROLLING DIMENSIONS : MILLIMETER
3. DIMENSION b APPLIES TO METALLIZED TERMINAL AND IS MEASURED BETWEEN 0.15 AND 0.30 mm. FROM TERMINAL TIP.

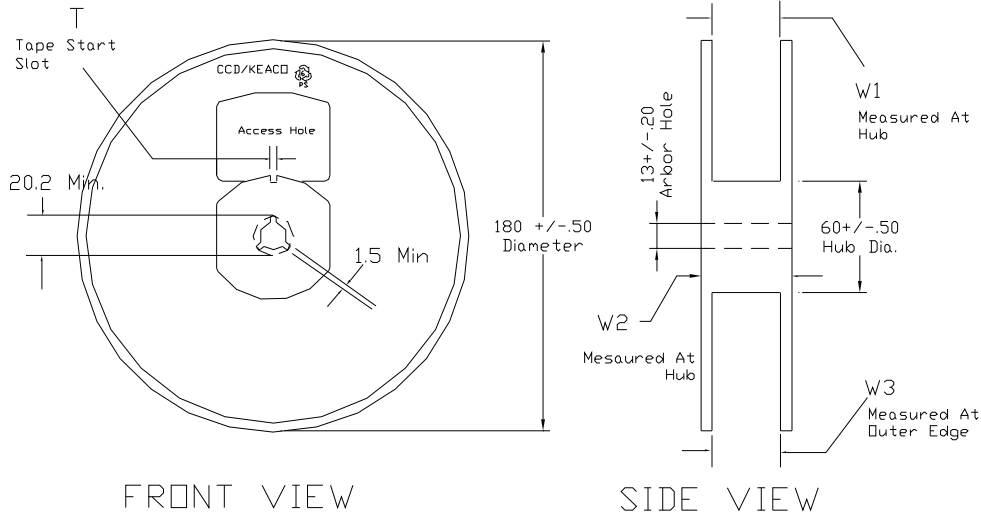
For footprint and stencil design recommendations, please refer to application note AN-1154 at <http://www.irf.com/technical-info/appnotes/an-1154.pdf>

PQFN 2x2 Outline Part Marking



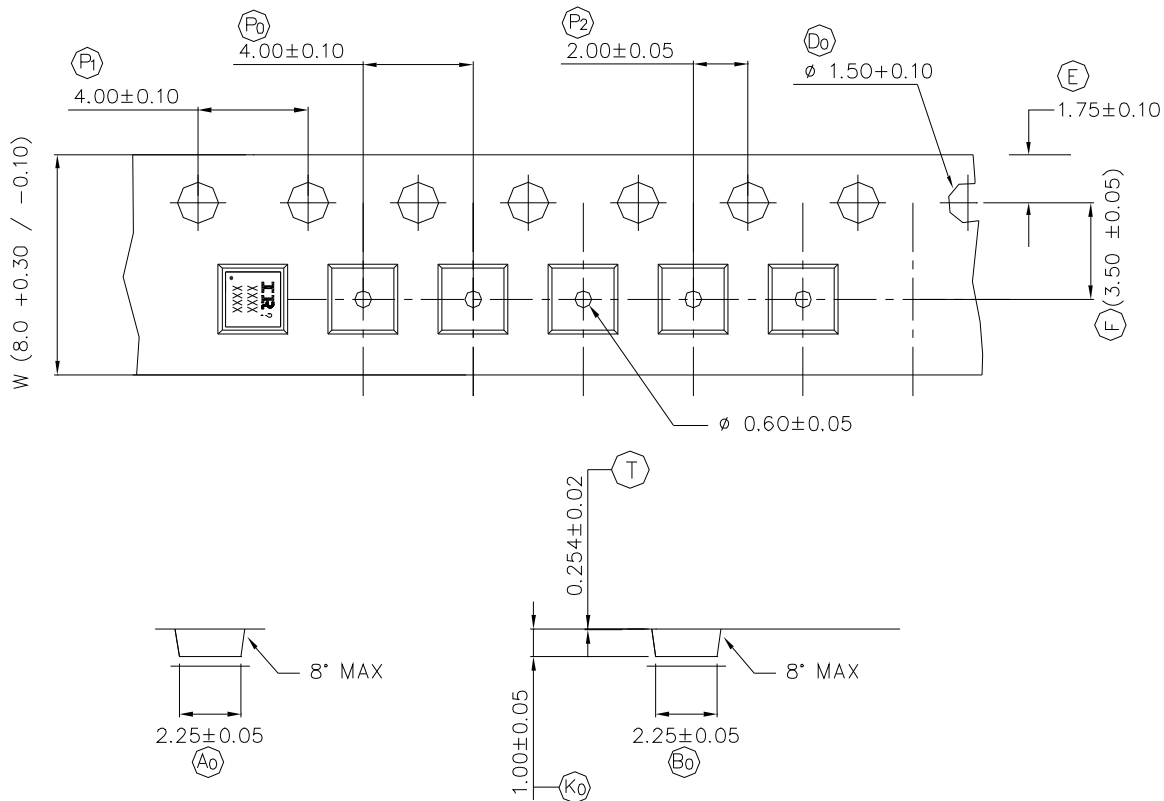
Note: For the most current drawing please refer to IR website at: <http://www.irf.com/package/>

PQFN 2x2 Outline Tape and Reel


TABLE 1: REEL DETAILS

TAPE WIDTH	T	W1	W2	W3	PART NO
8 MM	3 ± 0.50	8.4 ^{+1.5} _{-0.0}	14.4 Max	7.90 Min 10.9 Max	91586-1
12 MM	5 ± 0.50	12.4 ^{+2.0} _{-0.0}	18.4 Max	11.9 Min 15.4 Max	91586-2

Note: Surface resistivity is $\geq 1 \times 10^5$ but $< 1 \times 10^{12}$ ohm/sq.



Note: For the most current drawing please refer to IR website at: <http://www.irf.com/package/>

Qualification information[†]

Qualification level	Industrial [†] (per JEDEC JESD47F ^{††} guidelines)	
Moisture Sensitivity Level	PQFN 2mm x 2mm	MSL1 (per JEDEC J-STD-020D ^{††})
RoHS compliant	Yes	

† Qualification standards can be found at International Rectifier's web site
<http://www.irf.com/product-info/reliability>

†† Applicable version of JEDEC standard at the time of product release.

Revision History

Date	Comments
12/17/2013	<ul style="list-style-type: none"> • Updated ordering information to reflect the End-Of-life (EOL) of the mini-reel option (EOL notice #259) • Updated Qual level from "Consumer" to "Industrial" on page 1, 9 • Updated data sheet with new IR corporate template

单击下面可查看定价，库存，交付和生命周期等信息

[>>Infineon Technologies\(英飞凌\)](#)

[>>点击查看相关商品](#)