

Features

- $BV_{CEO} > 45V, 60V \& 80V$
- $I_C = 1A$ High Continuous Collector Current
- $I_{CM} = 2A$ Peak Pulse Current
- 2W Power Dissipation
- Low Saturation Voltage $V_{CE(sat)} < 500mV @ 0.5A$
- Gain Groups 10 and 16
- Complementary PNP Types: BCP51, 52 and 53
- **Totally Lead-Free & Fully RoHS Compliant (Notes 1 & 2)**
- **Halogen and Antimony Free. "Green" Device (Note 3)**
- **Qualified to AEC-Q101 Standards for High Reliability**
- **PPAP Capable (Note 4)**

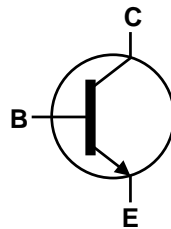

Top View

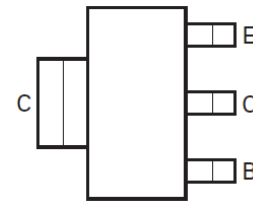

Device Symbol

 Top View
Pin-Out

Mechanical Data

- Case: SOT223
- Case Material: Molded Plastic. "Green" Molding Compound; UL Flammability Rating 94V-0
- Moisture Sensitivity: Level 1 per J-STD-020
- Terminals: Finish - Matte Tin Plated Leads. Solderable per MIL-STD-202, Method 208
- Weight: 0.112 grams (Approximate) (e3)

Applications

- Medium Power Switching or Amplification Applications
- AF Driver and Output Stages

Ordering Information (Notes 4 & 5)

Product	Compliance	Marking	Reel size (inches)	Tape width (mm)	Quantity per reel
BCP54TA	AEC-Q101	BCP 54	7	12	1,000
BCP5410TA	AEC-Q101	BCP 5410	7	12	1,000
BCP5416TA	AEC-Q101	BCP 5416	7	12	1,000
BCP5416QTA	Automotive	BCP 5416	7	12	1,000
BCP55TA	AEC-Q101	BCP 55	7	12	1,000
BCP5510TA	AEC-Q101	BCP 5510	7	12	1,000
BCP5516TA	AEC-Q101	BCP 5516	7	12	1,000
BCP56TA	AEC-Q101	BCP 56	7	12	1,000
BCP5610TA	AEC-Q101	BCP 5610	7	12	1,000
BCP5616TA	AEC-Q101	BCP 5616	7	12	1,000
BCP5616TC	AEC-Q101	BCP 5616	13	12	4,000
BCP5616QTA	Automotive	Refer to http://diodes.com/datasheets/BCP5616Q.pdf			
BCP5616QTC	Automotive	Refer to http://diodes.com/datasheets/BCP5616Q.pdf			

- Notes:
1. No purposely added lead. Fully EU Directive 2002/95/EC (RoHS) & 2011/65/EU (RoHS 2) compliant.
 2. See http://www.diodes.com/quality/lead_free.html for more information about Diodes Incorporated's definitions of Halogen- and Antimony-free, "Green" and Lead-free.
 3. Halogen- and Antimony-free "Green" products are defined as those which contain <900ppm bromine, <900ppm chlorine (<1500ppm total Br + Cl) and <1000ppm antimony compounds.
 4. Automotive products are AEC-Q101 qualified and are PPAP capable. Automotive, AEC-Q101 and standard products are electrically and thermally the same, except where specified. For more information, please refer to http://www.diodes.com/quality/product_compliance_definitions/.
 5. For packaging details, go to our website at <http://www.diodes.com/products/packages.html>.

Marking Information

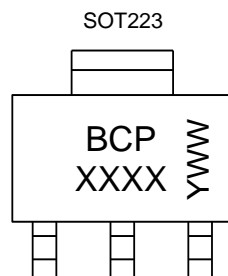

BCP = Product Type Marking Code, Line 1
 XXXX = Product Type Marking Code, Line 2 as follows:

BCP54 = 54	BCP55 = 55	BCP56 = 56
BCP5410 = 5410	BCP5510 = 5510	BCP5610 = 5610
BCP5416 = 5416	BCP5516 = 5516	BCP5616 = 5616

YWW = Date Code Marking
 Y or \bar{Y} = Last Digit of Year (ex: 5= 2015)
 WW or $\bar{W}W$ = Week Code (01~53)

Absolute Maximum Ratings (@T_A = +25°C, unless otherwise specified.)

Characteristic	Symbol	BCP54	BCP55	BCP56	Unit
Collector-Base Voltage	V _{CBO}	45	60	100	V
Collector-Emitter Voltage	V _{CEO}	45	60	80	V
Emitter-Base Voltage	V _{EBO}	5			V
Continuous Collector Current	I _C	1			A
Peak Pulse Collector Current	I _{CM}	2			
Continuous Base Current	I _B	100			mA
Peak Pulse Base Current	I _{BM}	200			

Thermal Characteristics (@T_A = +25°C, unless otherwise specified.)

Characteristic	Symbol	Value	Unit
Power Dissipation	(Note 6) P _D	2	W
Thermal Resistance, Junction to Ambient	(Note 6) R _{θJA}	62	°C/W
Thermal Resistance, Junction to Leads	(Note 7) R _{θJL}	19.4	°C/W
Operating and Storage Temperature Range	T _J , T _{STG}	-65 to +150	°C

ESD Ratings (Note 8)

Characteristic	Symbol	Value	Unit	JEDEC Class
Electrostatic Discharge - Human Body Model	ESD HBM	4,000	V	3A
Electrostatic Discharge - Machine Model	ESD MM	400	V	C

- Notes:
6. For a device mounted with the collector lead on 50mm x 50mm 1oz copper that is on a single-sided 1.6mm FR4 PCB; device is measured under still air conditions whilst operating in steady-state.
 7. Thermal resistance from junction to solder-point (at the end of the collector lead).
 8. Refer to JEDEC specification JESD22-A114 and JESD22-A115.

Thermal Characteristics and Derating Information

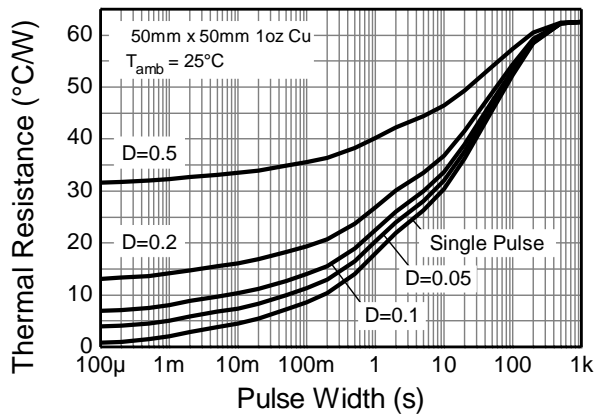

Transient Thermal Impedance

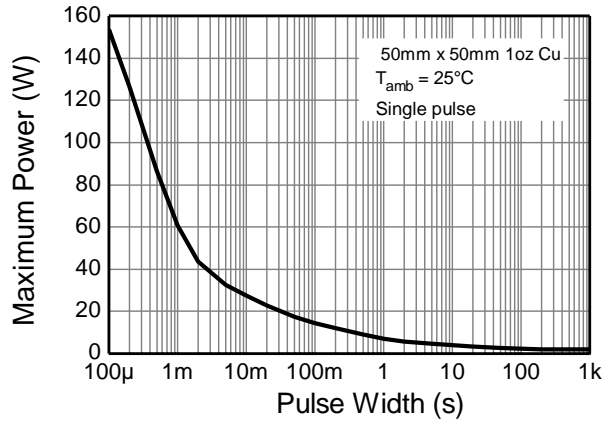

Pulse Power Dissipation

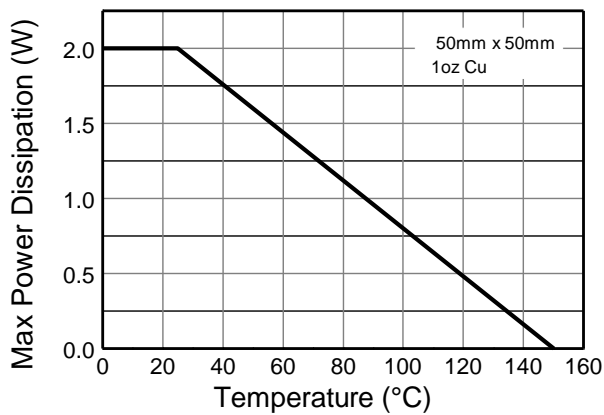

Derating Curve

Electrical Characteristics (@ $T_A = +25^\circ\text{C}$, unless otherwise specified.)

Characteristic		Symbol	Min	Typ	Max	Unit	Test Condition
Collector-Base Breakdown Voltage	BCP54	BV_{CBO}	45	-	-	V	$I_C = 100\mu\text{A}$
	BCP55		60				
	BCP56		100				
Collector-Emitter Breakdown Voltage (Note 9)	BCP54	BV_{CEO}	45	-	-	V	$I_C = 10\text{mA}$
	BCP55		60				
	BCP56		80				
Emitter-Base Breakdown Voltage		BV_{EBO}	5	-	-	V	$I_E = 10\mu\text{A}$
Collector Cut-Off Current		I_{CBO}	-	-	0.1 20	μA	$V_{CB} = 30\text{V}$ $V_{CB} = 30\text{V}, T_A = +150^\circ\text{C}$
Emitter Cut-Off Current		I_{EBO}	-	-	20	nA	$V_{EB} = 4\text{V}$
Static Forward Current Transfer Ratio (Note 9)	All versions	h_{FE}	25	-	-	-	$I_C = 5\text{mA}, V_{CE} = 2\text{V}$ $I_C = 150\text{mA}, V_{CE} = 2\text{V}$ $I_C = 500\text{mA}, V_{CE} = 2\text{V}$
			40	-	250		
			25	-	-		
			63	-	160		
	10 gain grp		100	-	250		$I_C = 150\text{mA}, V_{CE} = 2\text{V}$
	16 gain grp						$I_C = 150\text{mA}, V_{CE} = 2\text{V}$
Collector-Emitter Saturation Voltage (Note 9)		$V_{CE(sat)}$	-	-	0.5	V	$I_C = 500\text{mA}, I_B = 50\text{mA}$
Base-Emitter Turn-On Voltage (Note 9)		$V_{BE(on)}$	-	-	1.0	V	$I_C = 500\text{mA}, V_{CE} = 2\text{V}$
Transition Frequency		f_T	150	-	-	MHz	$I_C = 50\text{mA}, V_{CE} = 10\text{V}$ $f = 100\text{MHz}$
Output Capacitance		C_{obo}	-	-	25	pF	$V_{CB} = 10\text{V}, f = 1\text{MHz}$

Note: 9. Measured under pulsed conditions. Pulse width $\leq 300\mu\text{s}$. Duty cycle $\leq 2\%$.

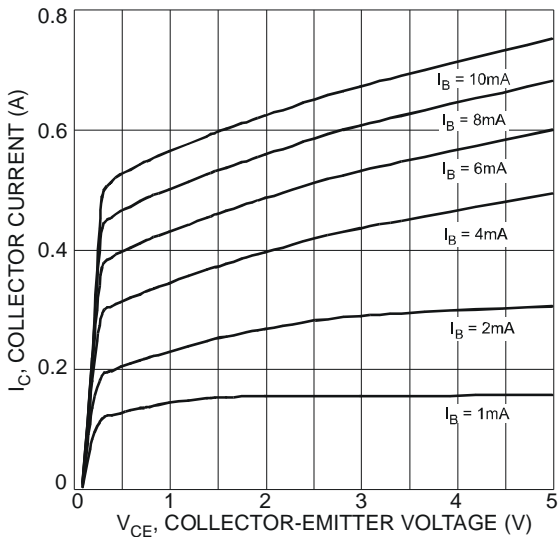

Fig. 1 Typical Collector Current vs. Collector-Emitter Voltage

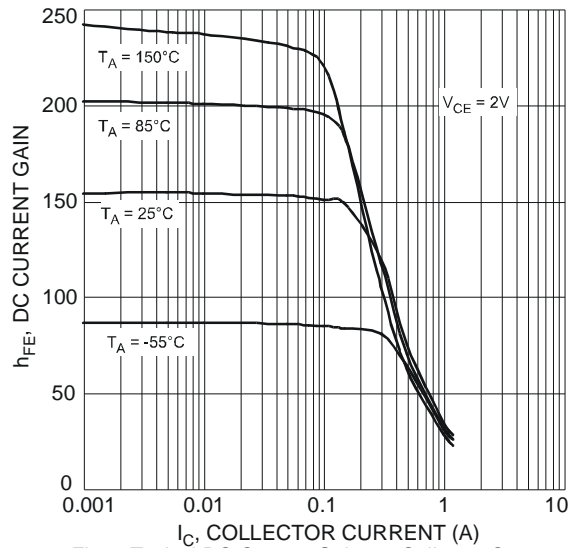

Fig. 2 Typical DC Current Gain vs. Collector Current

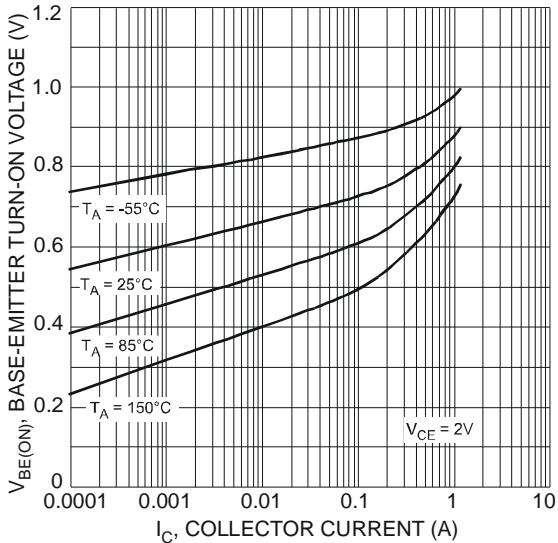

Fig. 3 Typical Base-Emitter Turn-On Voltage vs. Collector Current

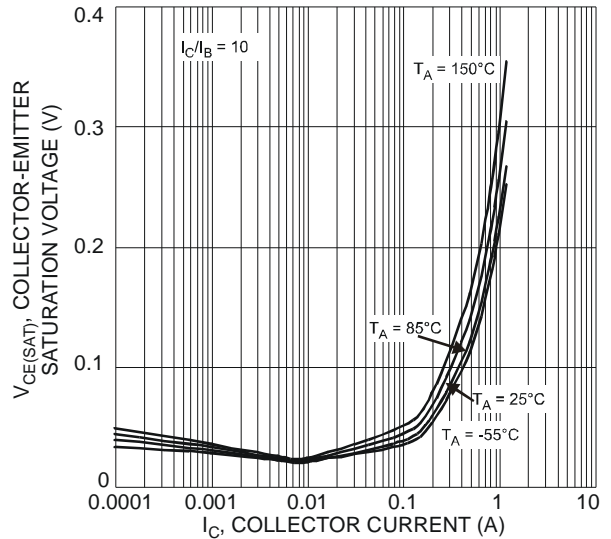

Fig. 4 Typical Collector-Emitter Saturation Voltage vs. Collector Current

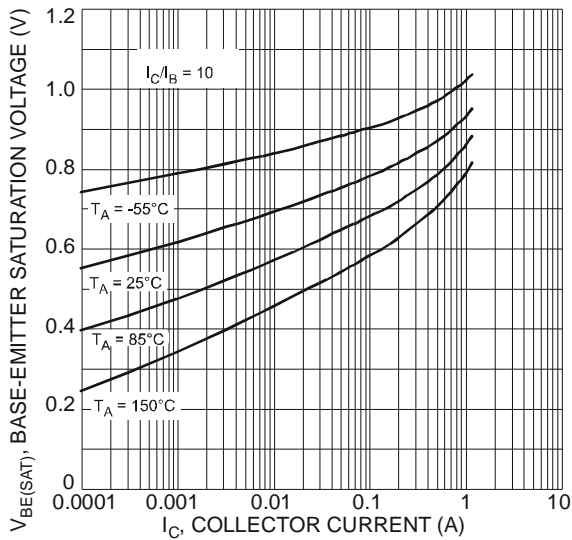

Fig. 5 Typical Base-Emitter Saturation Voltage vs. Collector Current

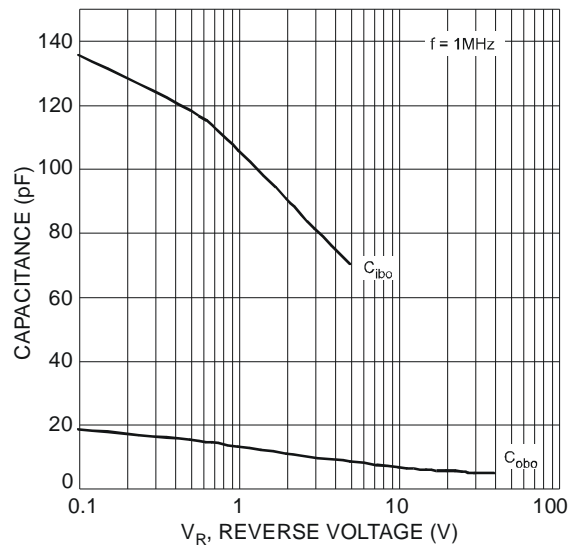

Fig. 6 Typical Capacitance Characteristics

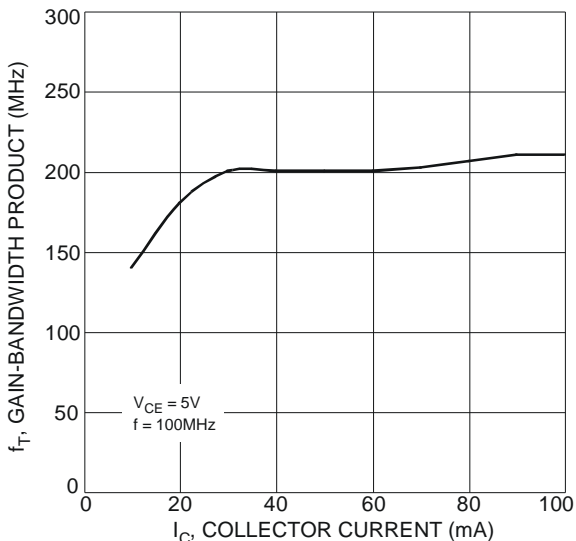
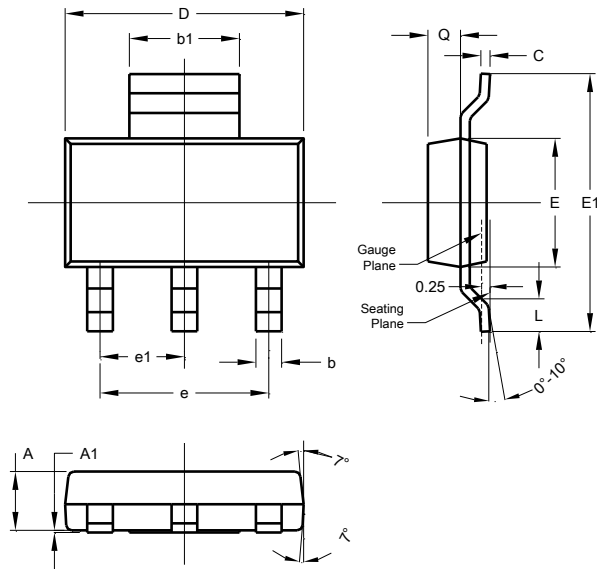

Fig. 7 Typical Gain-Bandwidth Product vs. Collector Current

Package Outline Dimensions

Please see AP02002 at <http://www.diodes.com/datasheets/ap02002.pdf> for the latest version.



SOT223			
Dim	Min	Max	Typ
A	1.55	1.65	1.60
A1	0.010	0.15	0.05
b	0.60	0.80	0.70
b1	2.90	3.10	3.00
C	0.20	0.30	0.25
D	6.45	6.55	6.50
E	3.45	3.55	3.50
E1	6.90	7.10	7.00
e	-	-	4.60
e1	-	-	2.30
L	0.85	1.05	0.95
Q	0.84	0.94	0.89
All Dimensions in mm			

Suggested Pad Layout

Please see AP02001 at <http://www.diodes.com/datasheets/ap02001.pdf> for the latest version.

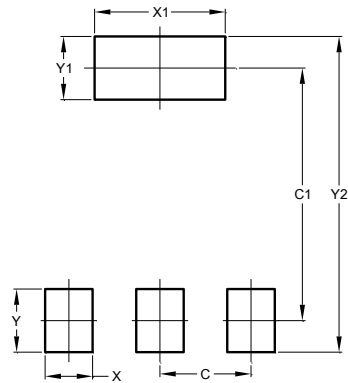

Dimensions	Value (in mm)
C	2.30
C1	6.40
X	1.20
X1	3.30
Y	1.60
Y1	1.60
Y2	8.00

IMPORTANT NOTICE

DIODES INCORPORATED MAKES NO WARRANTY OF ANY KIND, EXPRESS OR IMPLIED, WITH REGARDS TO THIS DOCUMENT, INCLUDING, BUT NOT LIMITED TO, THE IMPLIED WARRANTIES OF MERCHANTABILITY AND FITNESS FOR A PARTICULAR PURPOSE (AND THEIR EQUIVALENTS UNDER THE LAWS OF ANY JURISDICTION).

Diodes Incorporated and its subsidiaries reserve the right to make modifications, enhancements, improvements, corrections or other changes without further notice to this document and any product described herein. Diodes Incorporated does not assume any liability arising out of the application or use of this document or any product described herein; neither does Diodes Incorporated convey any license under its patent or trademark rights, nor the rights of others. Any Customer or user of this document or products described herein in such applications shall assume all risks of such use and will agree to hold Diodes Incorporated and all the companies whose products are represented on Diodes Incorporated website, harmless against all damages.

Diodes Incorporated does not warrant or accept any liability whatsoever in respect of any products purchased through unauthorized sales channel. Should Customers purchase or use Diodes Incorporated products for any unintended or unauthorized application, Customers shall indemnify and hold Diodes Incorporated and its representatives harmless against all claims, damages, expenses, and attorney fees arising out of, directly or indirectly, any claim of personal injury or death associated with such unintended or unauthorized application.

Products described herein may be covered by one or more United States, international or foreign patents pending. Product names and markings noted herein may also be covered by one or more United States, international or foreign trademarks.

This document is written in English but may be translated into multiple languages for reference. Only the English version of this document is the final and determinative format released by Diodes Incorporated.

LIFE SUPPORT

Diodes Incorporated products are specifically not authorized for use as critical components in life support devices or systems without the express written approval of the Chief Executive Officer of Diodes Incorporated. As used herein:

A. Life support devices or systems are devices or systems which:

1. are intended to implant into the body, or
2. support or sustain life and whose failure to perform when properly used in accordance with instructions for use provided in the labeling can be reasonably expected to result in significant injury to the user.

B. A critical component is any component in a life support device or system whose failure to perform can be reasonably expected to cause the failure of the life support device or to affect its safety or effectiveness.

Customers represent that they have all necessary expertise in the safety and regulatory ramifications of their life support devices or systems, and acknowledge and agree that they are solely responsible for all legal, regulatory and safety-related requirements concerning their products and any use of Diodes Incorporated products in such safety-critical, life support devices or systems, notwithstanding any devices- or systems-related information or support that may be provided by Diodes Incorporated. Further, Customers must fully indemnify Diodes Incorporated and its representatives against any damages arising out of the use of Diodes Incorporated products in such safety-critical, life support devices or systems.

Copyright © 2015, Diodes Incorporated

www.diodes.com

单击下面可查看定价，库存，交付和生命周期等信息

[>>Diodes Incorporated\(达尔科技\)](#)