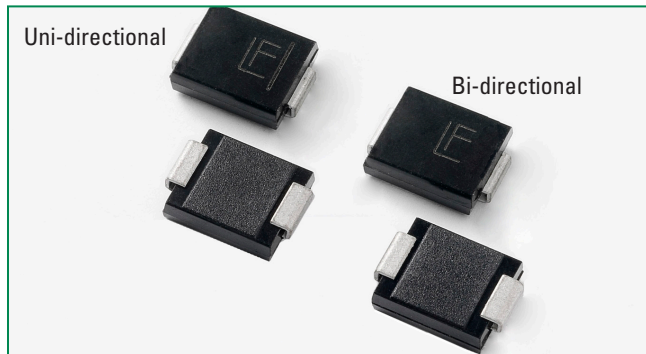


## TPSMD Series



### Agency Approvals

AGENCY	AGENCY FILE NUMBER
	E230531

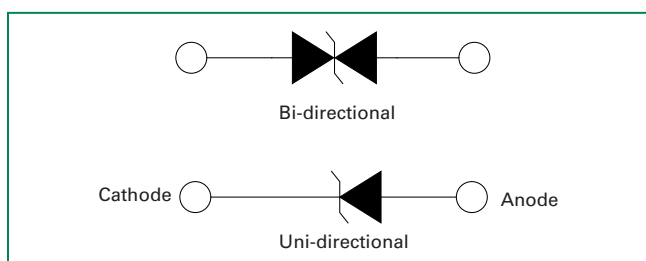
### Maximum Ratings and Thermal Characteristics (T<sub>A</sub>=25°C unless otherwise noted)

Parameter	Symbol	Value	Unit
Peak Pulse Power Dissipation at T <sub>A</sub> =25°C by 10/1000µs Waveform (Fig.2)(Note 1), (Note 2)	P <sub>PPM</sub>	3000	W
Power Dissipation on Infinite Heat Sink at T <sub>A</sub> =50°C	P <sub>M(AV)</sub>	6.5	W
Peak Forward Surge Current, 8.3ms Single Half Sine Wave (Note 3)	I <sub>FSM</sub>	300	A
Maximum Instantaneous Forward Voltage at 100A for Unidirectional Only	V <sub>F</sub>	3.5	V
Operating Junction and Storage Temperature Range	T <sub>J</sub> , T <sub>STG</sub>	-65 to 150	°C
Typical Thermal Resistance Junction to Lead	R <sub>wJL</sub>	15	°C/W
Typical Thermal Resistance Junction to Ambient	R <sub>wJA</sub>	75	°C/W

**Notes:**

1. Non-repetitive current pulse, per Fig. 4 and derated above T<sub>A</sub> = 25°C per Fig. 3.
2. Mounted on copper pad area of 0.31x0.31" (8.0 x 8.0mm) to each terminal.
3. Measured on 8.3ms single half sine wave or equivalent square wave for unidirectional device only, duty cycle=4 per minute maximum.

### Functional Diagram



### Description

The TPSMD series is designed specifically to protect sensitive electronic equipment from voltage transients induced by lightning and other transient voltage events.


### Features

- Hi reliability application and automotive grade AEC-Q101 qualified
- For surface mounted applications in order to optimize board space
- Low profile package
- Typical failure mode is short from over-specified voltage or current
- Whisker test is conducted based on JEDEC JESD201A per its table 4a and 4c
- IEC-61000-4-2 ESD 30kV(Air), 30kV (Contact)
- ESD protection of data lines in accordance with IEC 61000-4-2
- EFT protection of data lines in accordance with IEC 61000-4-4
- Built-in strain relief
- V<sub>BR</sub> @T<sub>J</sub> = V<sub>BR</sub> @25°C x (1 + α T x (T<sub>J</sub> - 25)) (α T: Temperature Coefficient)
- Glass passivated chip junction
- 3000W peak pulse power capability at 10/1000µs waveform, repetition rate (duty cycles):0.01 %
- Fast response time: typically less than 1.0ps from 0V to BV min
- Excellent clamping capability
- Low incremental surge resistance
- Typical I<sub>R</sub> less than 2µA above 12V
- High temperature soldering guaranteed: 260°C/10 seconds at terminals
- Plastic package is flammability rated V-0 per Underwriters Laboratories
- Meet MSL level1, per J-STD-020, LF maximum peak of 260°C
- Matte tin lead-free plated
- Halogen free and RoHS compliant
- Pb-free E3 means 2nd level interconnect is Pb-free and the terminal finish material is tin(Sn) (IPC/ JEDEC J-STD-609A.01)

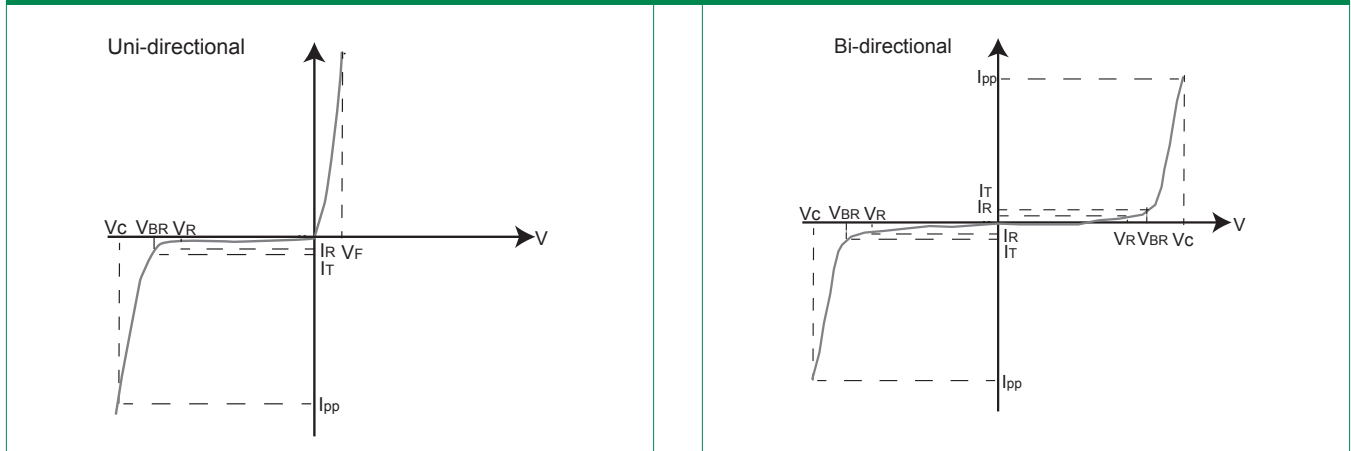
### Applications

TVS devices are ideal for the protection of I/O Interfaces, V<sub>CC</sub> bus and other vulnerable circuits used in Telecom, Computer, Industrial and Consumer electronic applications.

## Electrical Characteristics

Part Number (Uni)	Part Number (Bi)	Marking		Reverse Stand off Voltage $V_R$ (Volts)	Breakdown Voltage $V_{BR}$ (Volts) @ $I_T$		Test Current $I_T$ (mA)	Maximum Clamping Voltage $V_C$ @ $I_{pp}$ (V)	Maximum Peak Pulse Current $I_{pp}$ (A)	Maximum Reverse Leakage $I_R$ @ $V_R$ ( $\mu$ A)	Agency Approval 
		UNI	BI		MIN	MAX					
TPSMD10A	TPSMD10CA	PDXA	DDXA	10.0	11.10	12.30	1	17.0	176.5	5	X
TPSMD11A	TPSMD11CA	PDZA	DDZA	11.0	12.20	13.50	1	18.2	164.8	2	X
TPSMD12A	TPSMD12CA	PEEA	DEEA	12.0	13.30	14.70	1	19.9	150.8	2	X
TPSMD13A	TPSMD13CA	PEGA	DEGA	13.0	14.40	15.90	1	21.5	139.5	2	X
TPSMD14A	TPSMD14CA	PEKA	DEKA	14.0	15.60	17.20	1	23.2	129.3	2	X
TPSMD15A	TPSMD15CA	PEMA	DEMA	15.0	16.70	18.50	1	24.4	123.0	2	X
TPSMD16A	TPSMD16CA	PEPA	DEPA	16.0	17.80	19.70	1	26.0	115.4	2	X
TPSMD17A	TPSMD17CA	PERA	DERA	17.0	18.90	20.90	1	27.6	108.7	2	X
TPSMD18A	TPSMD18CA	PETA	DETA	18.0	20.00	22.10	1	29.2	102.7	2	X
TPSMD20A	TPSMD20CA	PEVA	DEVA	20.0	22.20	24.50	1	32.4	92.6	2	X
TPSMD22A	TPSMD22CA	PEXA	DEXA	22.0	24.40	26.90	1	35.5	84.5	2	X
TPSMD24A	TPSMD24CA	PEZA	DEZA	24.0	26.70	29.50	1	38.9	77.1	2	X
TPSMD26A	TPSMD26CA	PFEA	DFEA	26.0	28.90	31.90	1	42.1	71.3	2	X
TPSMD28A	TPSMD28CA	PFGA	DFGA	28.0	31.10	34.40	1	45.4	66.1	2	X
TPSMD30A	TPSMD30CA	PFKA	DFKA	30.0	33.30	36.80	1	48.4	62.0	2	X
TPSMD33A	TPSMD33CA	PFMA	DFMA	33.0	36.70	40.60	1	53.3	56.3	2	X
TPSMD36A	TPSMD36CA	PFFA	DFPA	36.0	40.00	44.20	1	58.1	51.6	2	X
TPSMD40A	TPSMD40CA	PFRA	DFRA	40.0	44.40	49.10	1	64.5	46.5	2	X
TPSMD43A	TPSMD43CA	PFTA	DFTA	43.0	47.80	52.80	1	69.4	43.2	2	X
TPSMD45A	TPSMD45CA	PFVA	DFVA	45.0	50.00	55.30	1	72.7	41.3	2	X
TPSMD48A	TPSMD48CA	PFXA	DFXA	48.0	53.30	58.90	1	77.4	38.8	2	X
TPSMD51A	TPSMD51CA	PFZA	DFZA	51.0	56.70	62.70	1	82.4	36.4	2	X
TPSMD54A	TPSMD54CA	RGEA	DGEA	54.0	60.00	66.30	1	87.1	34.4	2	X
TPSMD58A	TPSMD58CA	PGGA	DGGA	58.0	64.40	71.20	1	93.6	32.1	2	X
TPSMD60A	TPSMD60CA	PGKA	DGKA	60.0	66.70	73.70	1	96.8	31.0	2	X
TPSMD64A	TPSMD64CA	PGMA	DGMA	64.0	71.10	78.60	1	103.0	29.1	2	X
TPSMD70A	TPSMD70CA	PGPA	DGPA	70.0	77.80	86.00	1	113.0	26.5	2	X
TPSMD75A	TPSMD75CA	PGRA	DGRA	75.0	83.30	92.10	1	121.0	24.8	2	X
TPSMD78A	TPSMD78CA	PGTA	DGTA	78.0	86.70	95.80	1	126.0	23.8	2	X
TPSMD85A	TPSMD85CA	PGVA	DGVA	85.0	94.40	104.00	1	137.0	21.9	2	X

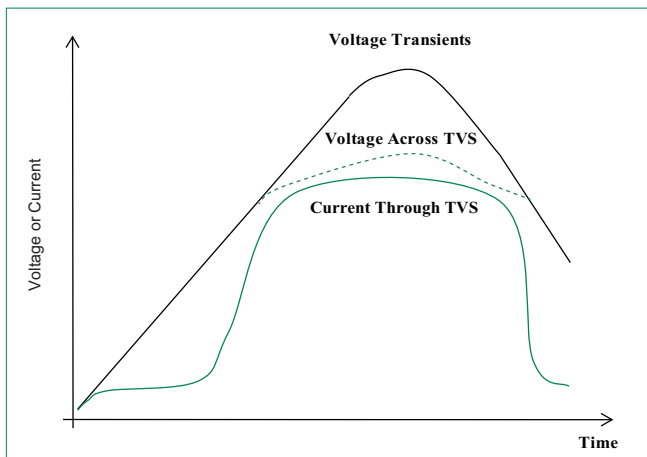
**I-V Curve Characteristics**



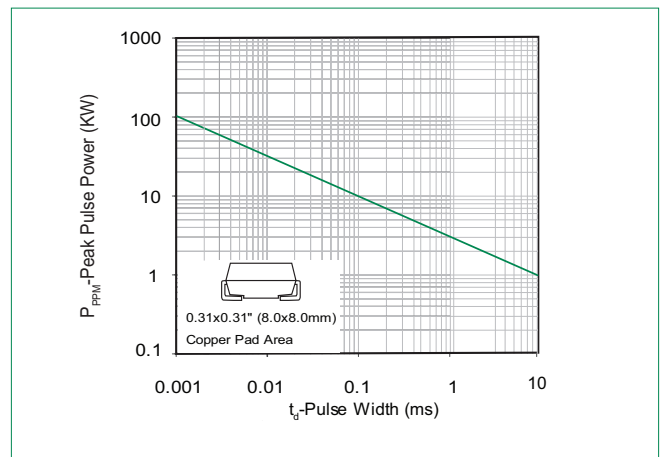
- $P_{PPM}$  Peak Pulse Power Dissipation** – Max power dissipation
- $V_R$  Stand-off Voltage** – Maximum voltage that can be applied to the TVS without operation
- $V_{BR}$  Breakdown Voltage** – Maximum voltage that flows thogh the TVS at a specified test current ( $I_T$ )
- $V_C$  Clamping Voltage** – Peak voltage measured across the TVS at a specified  $I_{ppm}$  (peak impulse current)
- $I_R$  Reverse Leakage Current** – Current measured at  $V_R$
- $V_F$  Forward Voltage Drop for Uni-directional**

**Ratings and Characteristic Curves** ( $T_A=25^\circ\text{C}$  unless otherwise noted)

**Figure 1 - TVS Transients Clamping Waveform**



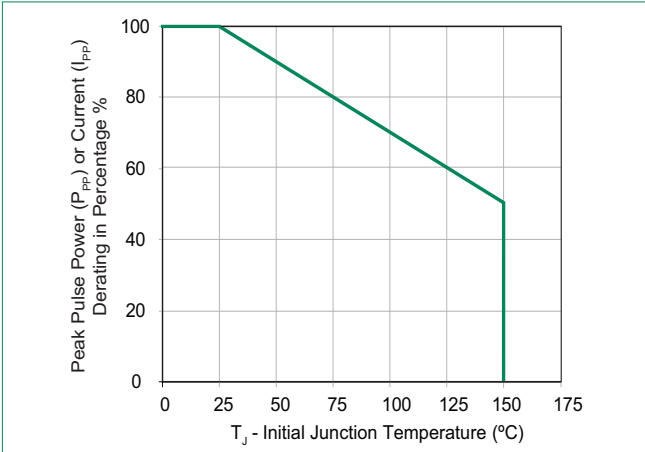
**Figure 2 - Peak Pulse Power Rating**



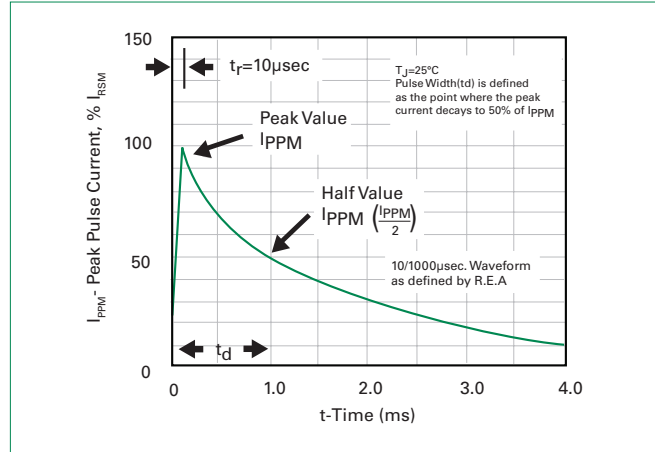
continues on next page.

**Ratings and Characteristic Curves** ( $T_J=25^\circ\text{C}$  unless otherwise noted) (Continued)

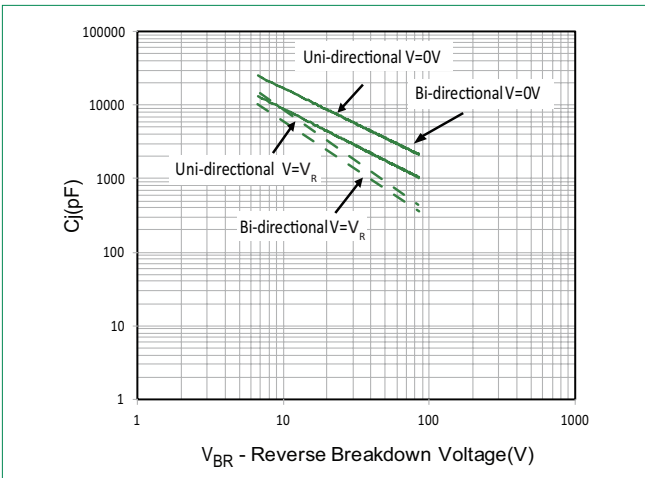
**Figure 3 - Peak Pulse Power Derating Curve**



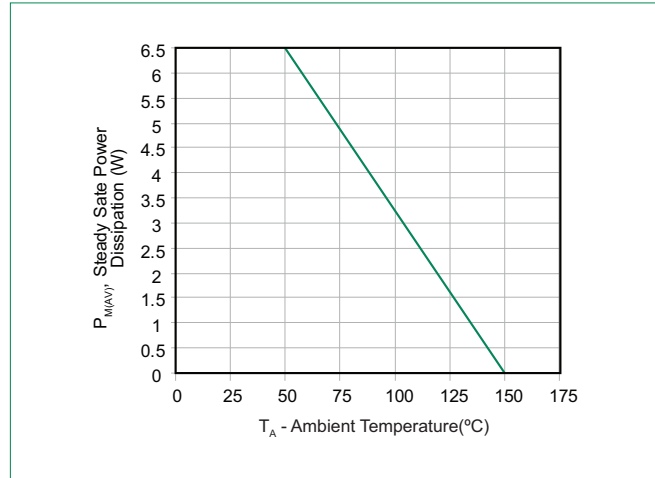
**Figure 4 - Pulse Waveform**



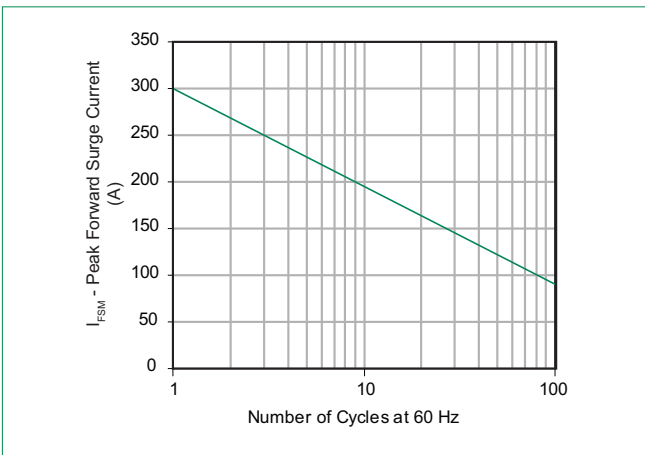
**Figure 5 - Typical Junction Capacitance**



**Figure 6 - Steady State Power Derating Curve**

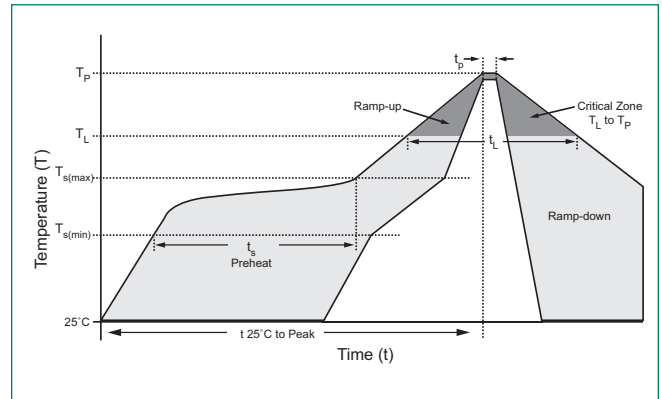


**Figure 7 - Maximum Non-Repetitive Peak Forward Surge Current Uni-Directional only**



### Soldering Parameters

Reflow Condition	Lead-free assembly	
Pre Heat	- Temperature Min ( $T_{s(min)}$ )	150°C
	- Temperature Max ( $T_{s(max)}$ )	200°C
	- Time (min to max) ( $t_s$ )	60 – 120 secs
Average ramp up rate (Liquidus Temp ( $T_L$ ) to peak)	3°C/second max	
$T_{s(max)}$ to $T_L$ - Ramp-up Rate	3°C/second max	
Reflow	- Temperature ( $T_L$ ) (Liquidus)	217°C
	- Time (min to max) ( $t_s$ )	60 – 150 seconds
Peak Temperature ( $T_p$ )	260 <sup>+0/-5</sup> °C	
Time within 5°C of actual peak Temperature ( $t_p$ )	30 seconds max	
Ramp-down Rate	6°C/second max	
Time 25°C to peak Temperature ( $T_p$ )	8 minutes max.	
Do not exceed	260°C	



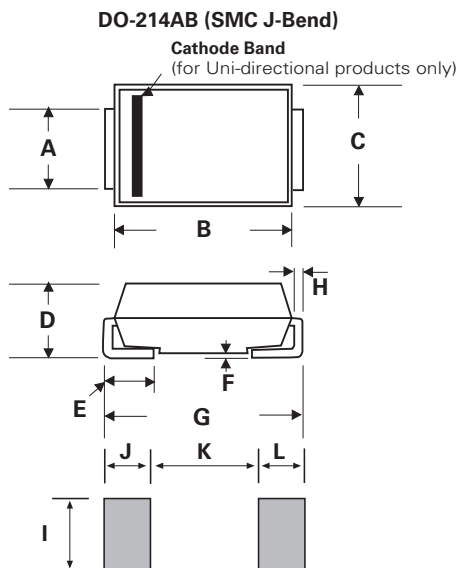
### Physical Specifications

<b>Weight</b>	0.007 ounce, 0.21 grams
<b>Case</b>	JEDEC DO214AB. Molded plastic body over glass passivated junction
<b>Polarity</b>	Color band denotes positive end (cathode) except Bidirectional.
<b>Terminal</b>	Matte Tin-plated leads, Solderable per JESD22-B102

### Environmental Specifications

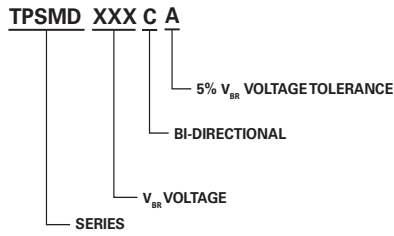
<b>High Temp. Storage</b>	JESD22-A103
<b>HTRB</b>	JESD22-A108
<b>Temperature Cycling</b>	JESD22-A104
<b>MSL</b>	JEDEC-J-STD-020, Level 1
<b>H3TRB</b>	JESD22-A101
<b>RSH</b>	JESD22-A111

### Dimensions

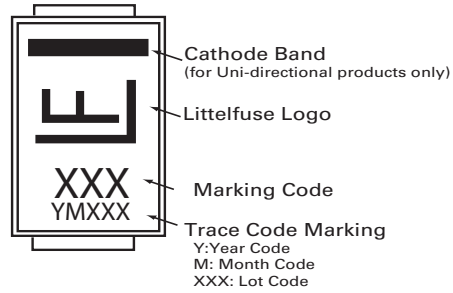


Dimensions	Inches		Millimeters	
	Min	Max	Min	Max
A	0.114	0.126	2.900	3.200
B	0.260	0.280	6.600	7.110
C	0.220	0.245	5.590	6.220
D	0.079	0.103	2.060	2.620
E	0.030	0.060	0.760	1.520
F	-	0.008	-	0.203
G	0.305	0.320	7.750	8.130
H	0.006	0.012	0.152	0.305
I	0.129	-	3.300	-
J	0.094	-	2.400	-
K	-	0.165	-	4.200
L	0.094	-	2.400	-

**Part Numbering System**



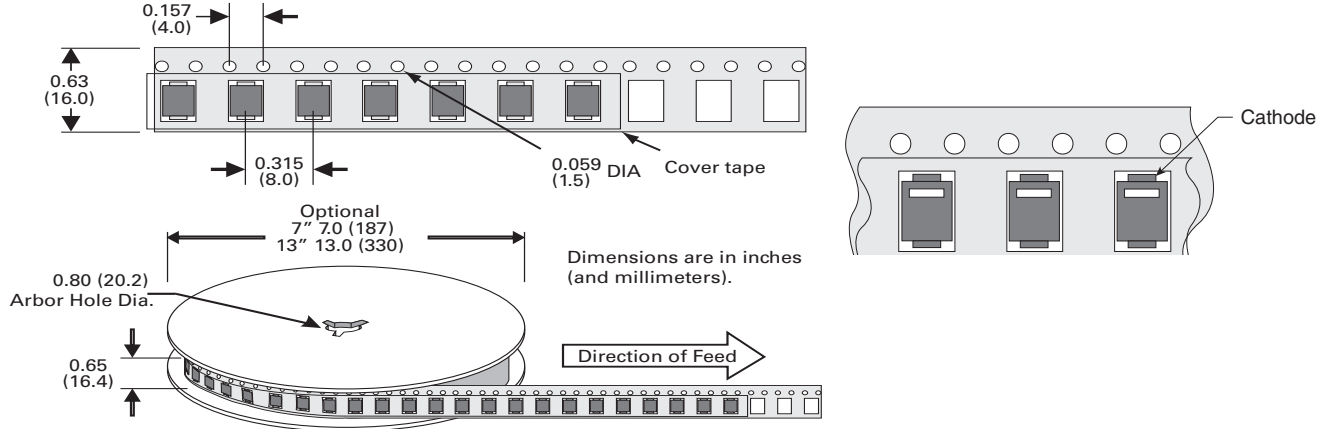
**Part Marking System**



**Packaging Options**

Part number	Component Package	Quantity	Packaging Option	Packaging Specification
TPSMDxxxXX	DO-214AB	3000	Tape & Reel - 16mm tape / 13" reel	EIA STD RS-481
TPSMDxxxXX-T7	DO-214AB	500	Tape & Reel - 16mm tape / 7" reel	EIA STD RS-481

**Tape and Reel Specification**



单击下面可查看定价，库存，交付和生命周期等信息

[>>Littelfuse\(美国力特\)](#)