

FEATURES

- Low Cost
- Rail-to-Rail Input and Output
0.8mV Typical V_{OS}
- Unity Gain Stable
- Gain-Bandwidth Product: 1MHz
- Very Low Input Bias Current: 10pA
- Supply Voltage Range: 2.1V to 5.5V
- Input Voltage Range:
-0.1V to +5.6V with $(V_{DD} - V_{SS}) = 5.5V$
- Low Supply Current: 40 μ A/Amplifier
- Small Packaging
MD1321 Available in SOT-23-5
MD1322 Available in SOIC-8

APPLICATIONS

- ASIC Input or Output Amplifier
- Sensor Interface
- Piezoelectric Transducer Amplifier
- Medical Instrumentation
- Mobile Communication
- Audio Output
- Portable Systems
- Smoke Detectors
- Notebook PC
- PCMCIA Cards
- Battery-Powered Equipment
- DSP Interface

PIN CONFIGURATIONS (TOP VIEW)

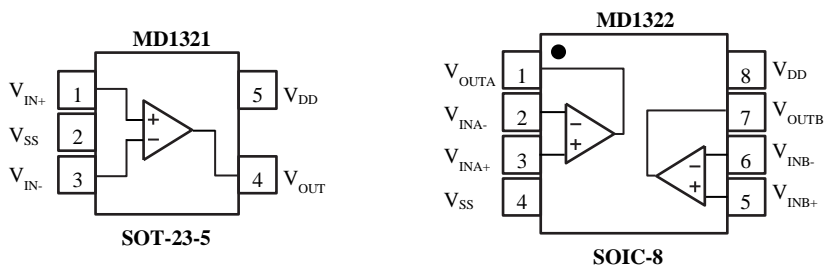

PRODUCT DESCRIPTION

The MD1321 (single), MD1322 (dual) are low cost, rail-to-rail input and output voltage feedback amplifiers. They have a wide input common mode voltage range and output voltage swing, and take the minimum operating supply voltage down to 2.1V. The maximum recommended supply voltage is 5.5V. It is specified over the extended -40 $^{\circ}$ C to +85 $^{\circ}$ C temperature range.

The MD1321/2 provide 1MHz bandwidth at a low current consumption of 40 μ A per amplifier. Very low input bias currents of 10pA enable MD1321/2 to be used for integrators, photodiode amplifiers, and piezoelectric sensors. Rail-to-rail input and output are useful to designers for buffering ASIC in single-supply systems.

Applications for this series of amplifiers include safety monitoring, portable equipment, battery and power supply control, and signal conditioning and interfacing for transducers in very low power systems.

The MD1321 is available in the Green SOT-23-5 Package. The MD1322 comes in the Green SOIC-8 package.

ORDER INFORMATION

MODEL	ORDER NUMBER	PACKAGE DESCRIPTION	PACKAGE OPTION	MARKING INFORMATION
MD1321	--	SOT23-5	Tape and Reel, 2500	--
MD1322	--	SOIC-8	Tape and Reel, 2500	--

ABSOLUTE MAXIMUM RATINGS

Supply Voltage, V_{DD} to V_{SS}	6V	Package Thermal Resistance @ $T_A = +25^\circ\text{C}$	
Common Mode Input Voltage.....	$V_{SS} - 0.3\text{V}$ to $V_{DD} + 0.3\text{V}$	SOIC-8, θ_{JA}	125 $^\circ\text{C}/\text{W}$
Storage Temperature Range.....	-65 $^\circ\text{C}$ to +150 $^\circ\text{C}$	Lead Temperature (Soldering 10sec).....	260 $^\circ\text{C}$
Junction Temperature.....	150 $^\circ\text{C}$		
Operating Temperature Range.....	-40 $^\circ\text{C}$ to +85 $^\circ\text{C}$		

NOTE:

Stresses beyond those listed under “Absolute Maximum Ratings” may cause permanent damage to the device. These are stress ratings only, and functional operation of the device at these or any other conditions beyond those indicated in the operational sections of the specifications is not implied. Exposure to absolute maximum rating conditions for extended periods may affect device reliability.

ESD, Electrostatic Discharge Protection

Symbol	Parameter	Condition	Minimum Level	Unit
HBM	Human Body Model ESD		4	kV
MM	Machine Model ESD		300	V

ELECTRICAL CHARACTERISTICS

The • denotes the specifications which apply over the full operating temperature range, otherwise specifications are At $T_A=25^{\circ}\text{C}$, $V_{DD} = +5\text{V}$, $V_{SS} = \text{GND}$, $R_L = 100\text{k}\Omega$ connected to $V_{DD}/2$, and $V_{OUT} = V_{DD}/2$.

PARAMETER	SYMBOL	CONDITIONS	MIN	TYP	MAX	UNITS
INPUT CHARACTERISTICS						
Input Offset Voltage	V_{OS}	$V_{CM} = V_{DD}/2$		0.8	5	mV
		$V_{CM} = V_{DD}/2$	•		6.6	
Input Bias Current	I_B			10		pA
Input Offset Current	I_{OS}			10		pA
Input Offset Voltage Drift	$\Delta V_{OS}/\Delta T$			2		$\mu\text{V}/^{\circ}\text{C}$
Input Common Mode Voltage Range	V_{CM}	$V_{DD} = 5.5\text{V}$		-0.1-5.6		V
Common Mode Rejection Ratio	CMRR	$V_{DD} = 5.5\text{V}$, $V_{CM} = -0.1\text{V}$ to 4V		76		dB
Open-Loop Voltage Gain	A_{OL}	$R_L = 100\text{k}\Omega$, $V_{OUT} = 2.5\text{V}$		95		dB
		$R_L = 100\text{k}\Omega$, $V_{OUT} = +0.2\text{V}$ to $+4.8\text{V}$		93		dB
OUTPUT CHARACTERISTICS						
Output Voltage Swing from Rail	V_{OH}	$R_L = 100\text{k}\Omega$		4.980	4.995	V
	V_{OL}	$R_L = 100\text{k}\Omega$		25	5	mV
	V_{OH}	$R_L = 10\text{k}\Omega$		4.970	4.994	V
	V_{OL}	$R_L = 10\text{k}\Omega$		35	6	mV
Output Current	I_{SOURCE}	$R_L = 10\Omega$ to $V_{DD}/2$		40		mA
	I_{SINK}			40		
POWER SUPPLY						
Operating Voltage Range				2.1		V
			•	2.5	5.5	V
Power Supply Rejection Ratio	PSRR	$V_{DD} = +2.5\text{V}$ to $+5.5\text{V}$, $V_{CM} = +0.5\text{V}$		85		dB
Quiescent Current/Amplifier	I_Q			40		μA
			•	35	80	
DYNAMIC PERFORMANCE ($C_L = 100\text{pF}$)						
Gain-Bandwidth Product	GBP			1		MHz
Phase Margin	PM	$R_L = 100\text{k}\Omega$, $C_L = 100\text{pF}$		45		$^{\circ}$
Harmonic Distortion	HD2	$f = 10\text{kHz}$, $G = +1$, $R_L = 100\text{k}$, $V_{OUT} = 2V_{PP}$		>80		dBc
	HD3	$f = 10\text{kHz}$, $G = +1$, $R_L = 100\text{k}$, $V_{OUT} = 2V_{PP}$		>80		
Slew Rate	SR	$G = +1$, 2V Output Step		0.64		$\text{V}/\mu\text{s}$
Settling Time to 0.1%	t_s	$G = +1$, 2V Output Step		6		μs
Overload Recovery Time		$V_{IN} \cdot G = V_{DD}$		2.5		μs
NOISE PERFORMANCE						
Voltage Noise Density	e_n	$f = 1\text{kHz}$		30		$\text{nV}/\sqrt{\text{Hz}}$
		$f = 10\text{kHz}$		20		$\text{nV}/\sqrt{\text{Hz}}$

TYPICAL PERFORMANCE CHARACTERISTICS

At $T_A = +25^\circ\text{C}$, $V_{DD} = +5\text{V}$, $V_{SS} = \text{GND}$, and $R_L = 100\text{k}\Omega$ connected to $V_{DD}/2$, unless otherwise specified.

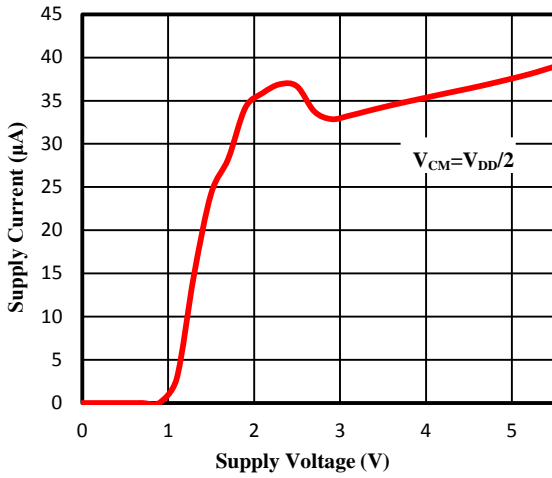

Figure 1. Supply Current vs. Supply Voltage

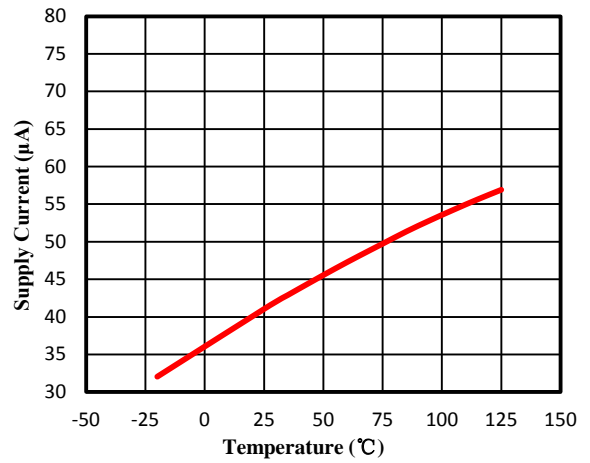

Figure 2. Supply Current vs. Temperature

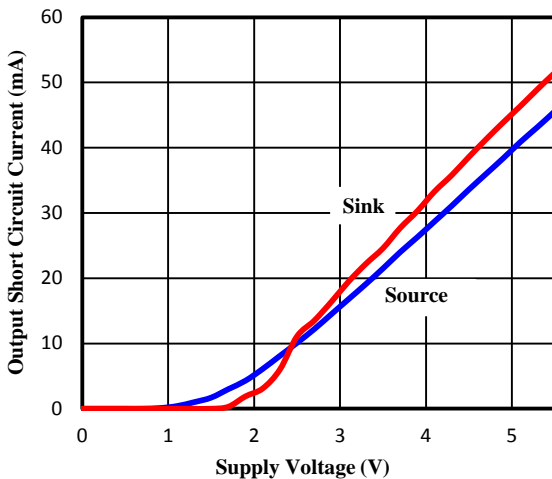

Figure 3. Output Short Circuit Current vs. Supply Voltage

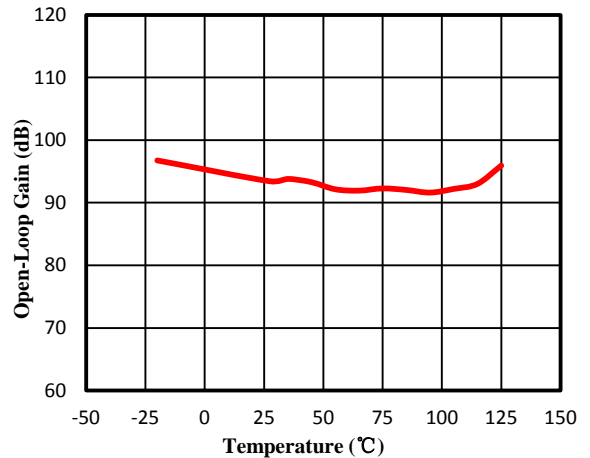

Figure 4. Open-Loop Gain vs. Temperature

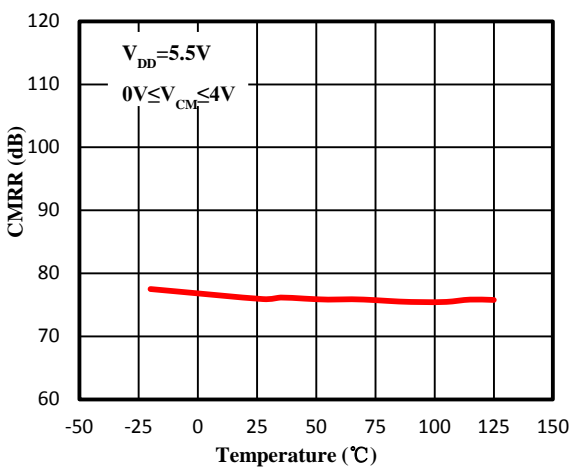

Figure 5. CMRR vs. Temperature

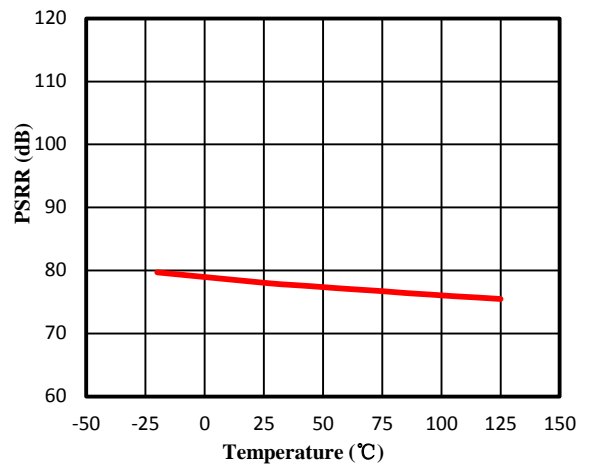

Figure 6. PSRR vs. Temperature

TYPICAL PERFORMANCE CHARACTERISTICS

At $T_A = +25^\circ\text{C}$, $V_{DD} = +5\text{V}$, $V_{SS} = \text{GND}$, and $R_L = 100\text{k}\Omega$ connected to $V_{DD}/2$, unless otherwise specified.

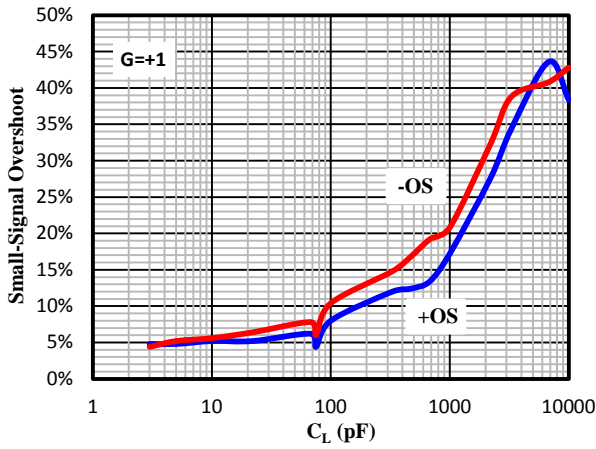

Figure 7. Small-Signal Overshoot vs. Load Capacitance

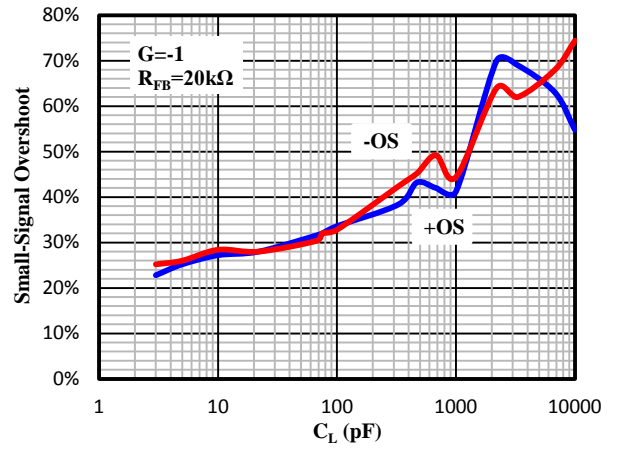

Figure 8. Small-Signal Overshoot vs. Load Capacitance

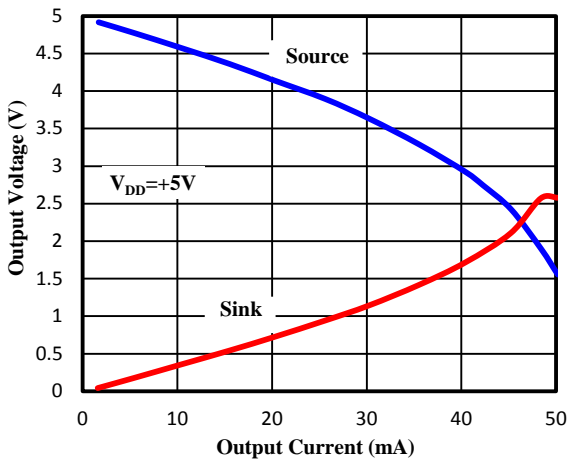

Figure 9. Output Voltage vs. Output Current

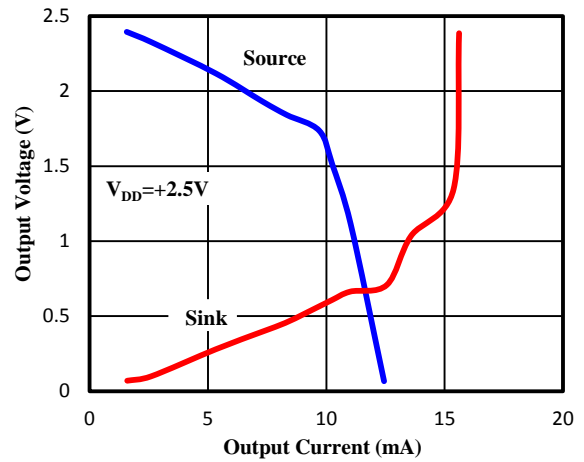

Figure 10. Output Voltage vs. Output Current

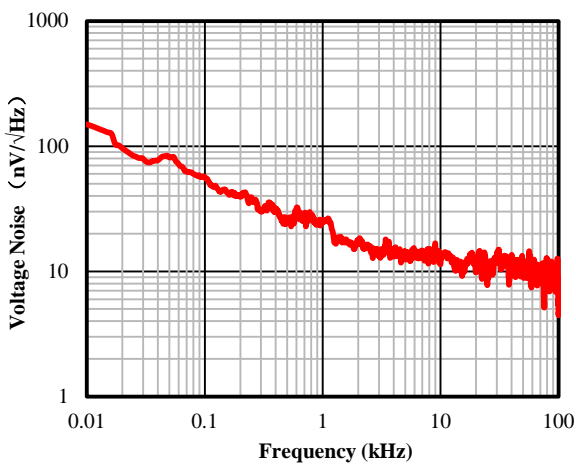

Figure 11. Input Voltage Noise Spectral Density vs. Frequency

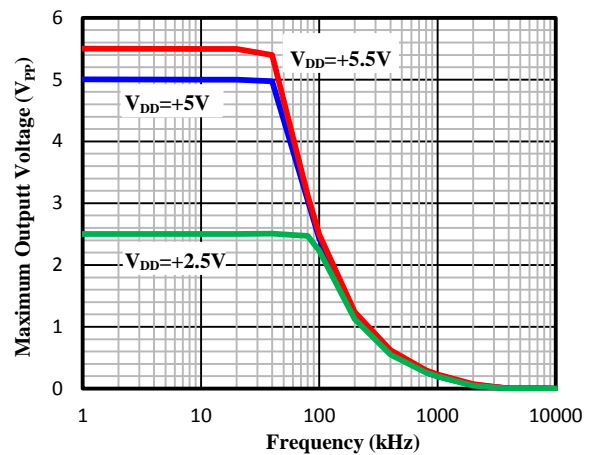

Figure 12. Maximum Output Voltage vs. Frequency

TYPICAL PERFORMANCE CHARACTERISTICS

At $T_A = +25^\circ\text{C}$, $V_{DD} = +5\text{V}$, $V_{SS} = \text{GND}$, and $R_L = 100\text{k}\Omega$ connected to $V_{DD}/2$, unless otherwise specified

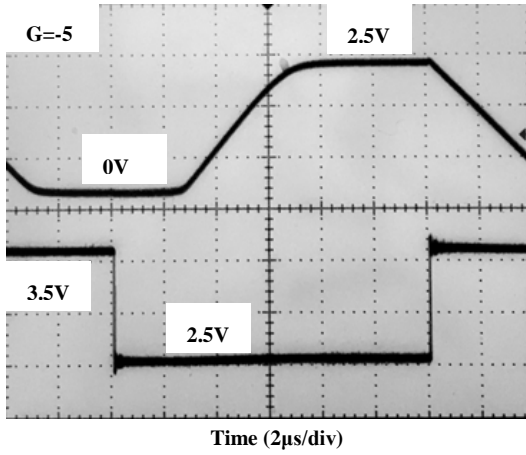

Figure 13. Positive Overload Recovery Time

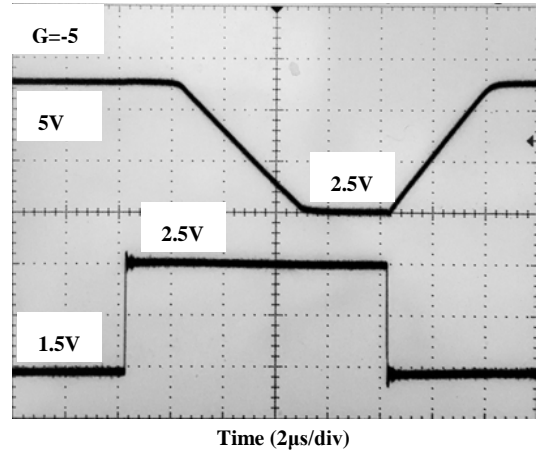

Figure 14. Negative Overload Recovery Time

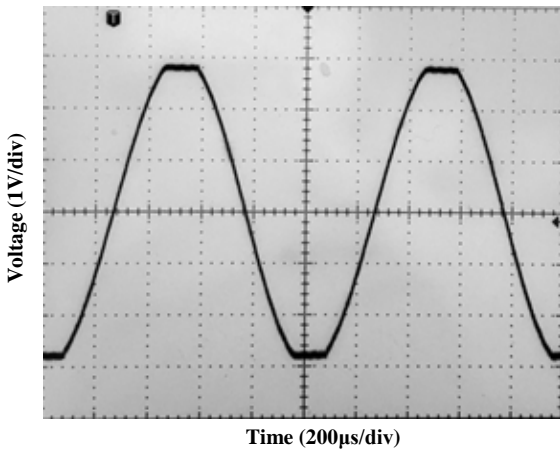

Figure 15. Phase Reversal

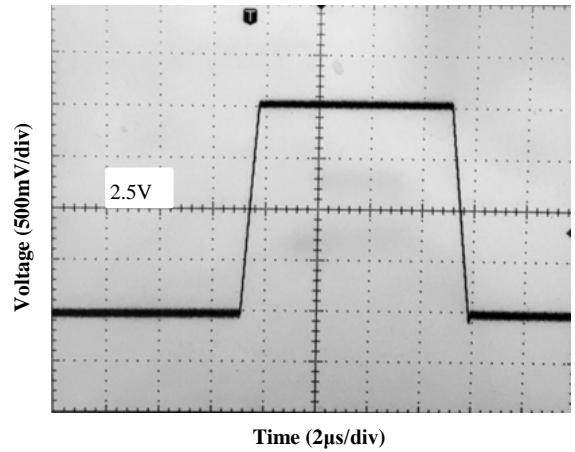

Figure 16. Large-Signal Step Response

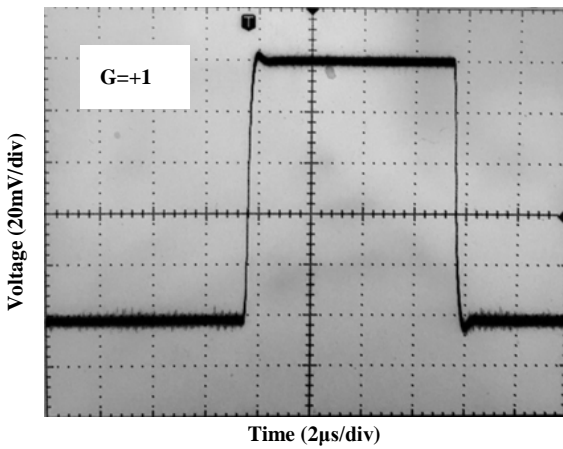

Figure 17. Small-Signal Step Response

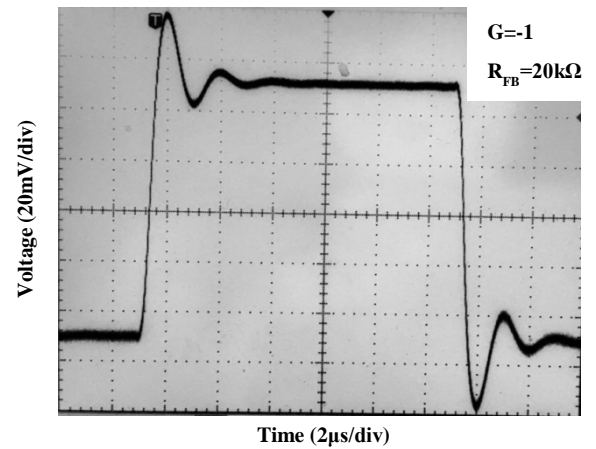

Figure 18. Small-Signal Step Response

TYPICAL PERFORMANCE CHARACTERISTICS

At $T_A = +25^\circ\text{C}$, $V_{DD} = +5\text{V}$, $V_{SS} = \text{GND}$, and $R_L = 100\text{k}\Omega$ connected to $V_{DD}/2$, unless otherwise specified.

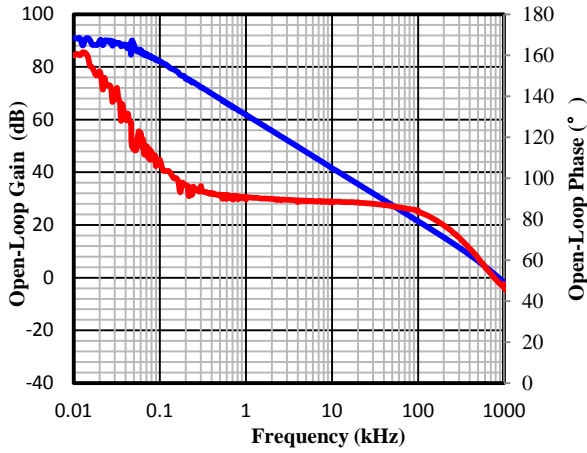

Figure 19. Gain and Phase vs. Frequency

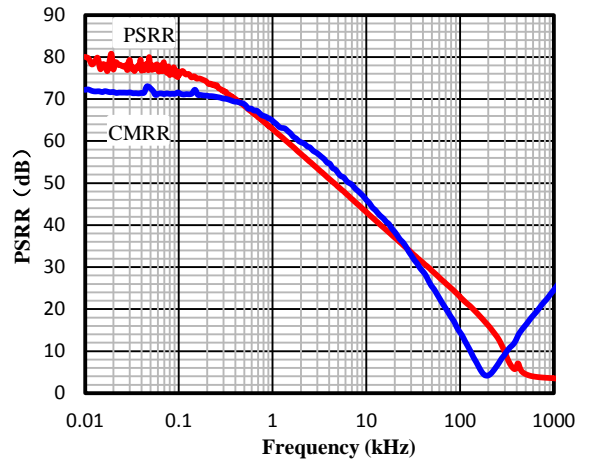

Figure 20. CMRR and PSRR vs. Frequency

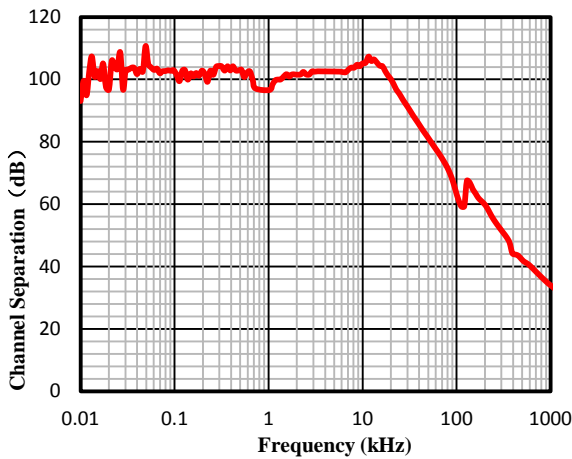

Figure 21. Channel Separation vs. Frequency

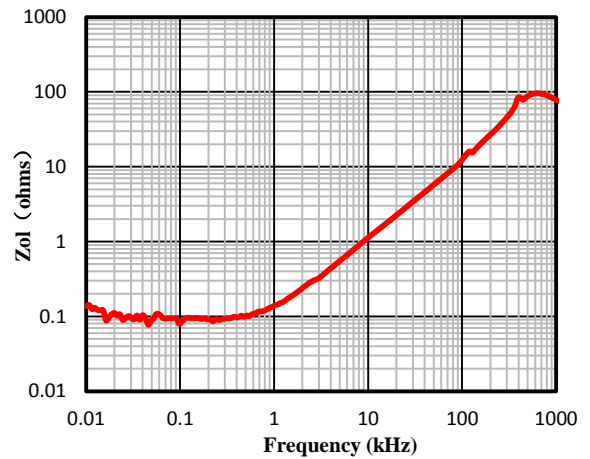

Figure 22. Zol vs. Frequency

MD1321/2

APPLICATION INFORMATION

MD1321/2 are CMOS, rail-to-rail input and output voltage feedback amplifiers designed for general purpose applications.

Operating Voltage

The MD1321/2 are specified over a power-supply range of +2.1V to +5.5V (±1.05V to ±2.75V), Supply voltages higher than 6V (absolute maximum) can permanently damage the amplifier.

Parameters that vary over supply voltage or temperature are shown in the typical characteristics section of this datasheet.

Rail-to-Rail Input

The input stage of the amplifiers is a true rail-to-rail architecture, allowing the input common-mode voltage range of the op amp to extend to both positive and negative supply rails. This maximizes the usable voltage range of the amplifier, an important feature for single-supply and low voltage applications. This rail-to-rail input range is achieved with a complementary input stage—an NMOS input differential pair in parallel with a PMOS differential pair. The NMOS pair is active at the upper end of the common-mode voltage range, typically $V_{DD} - 1.2V$ to 100mV above the positive supply, while the PMOS pair is active for inputs from 100mV below the negative supply to approximately $V_{DD} - 1.2V$.

Rail-to-Rail Output

A class AB output stage with common-source transistors is used to achieve rail-to-rail output. The maximum output voltage swing is proportional to the output current, and larger currents will limit how close the output voltage can get to the proximity of the output voltage to the supply rail. This is a characteristic of all rail-to-rail output amplifiers. See the typical performance characteristic Figure 9, Output Voltage Swing vs. Output Current.

Capacitive Loads

The MD1321/2 op amps can directly drive large capacitive loads. As the load capacitance increases, the feedback loop's phase margin decreases and the closed-loop's bandwidth is reduced. This produces gain peaking in the frequency response, with overshoot and ringing in the step response. While a op amp in unity gain configuration ($G = +1$ V/V) is most susceptible to the effects of capacitive loading.

When driving large capacitive loads with the MD1321/2 amplifiers (e.g., > 100pF when $G = +1$ V/V), a small series resistor at the output (R_{ISO} in Figure 23) improves the feedback

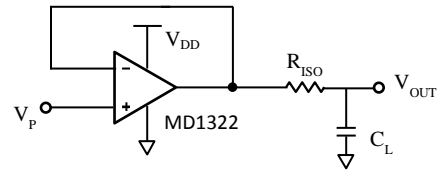

Figure 23. Driving Large Capacitive Loads

loop's phase margin (stability) by making the output load resistive at higher frequencies.

PCB Surface Leakage

In Applications where low input bias current is critical, PCB board surface leakage effects need to be considered. Surface leakage is caused by humidity, dust or other contamination on the board. Under low humidity conditions, a typical resistance between nearby traces is $10^{12} \Omega$. A 5V difference would cause 5pA of current to flow; which is similar to the MD1321/2 op amps' bias current at +25°C (±10pA, typical).

The best way to reduce surface leakage is to use a guard ring around sensitive pins (or traces). The guard ring is biased at the same voltage as the sensitive pin. An example of this type of layout is shown in Figure 24.

1. Non-inverting Gain and Unity-Gain Buffer:
 - a) Connect the non-inverting pin (V_{IN+}) to the input with a wire that does not touch the PCB surface.
 - b) Connect the guard ring to the inverting input pin (V_{IN-}). This biases the guard ring to the Common Mode input voltage.
2. Inverting Gain and Transimpedance Gain Amplifiers (convert current to voltage, such as photo detectors):
 - a) Connect the guard ring to the non-inverting input pin (V_{IN+}). This biases the guard ring to the same reference voltage as the op amp (e.g., $V_{DD}/2$ or ground).
 - b) Connect the inverting pin (V_{IN-}) to the input with a wire that does not touch the PCB surface.

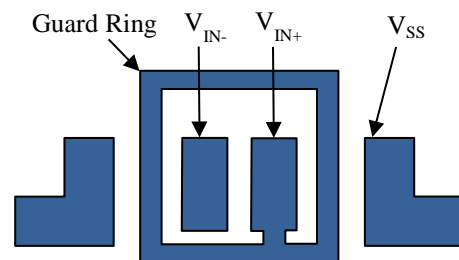

Figure 24. Example Guard Ring Layout for Inverting Gain

TYPICAL APPLICATION

Differential Amplifier

The circuit shown in Figure 25 performs the difference function. If the resistor ratios are equal to ($R_4 / R_3 = R_2 / R_1$), then $V_{OUT} = (V_P - V_N) \times R_2 / R_1 + V_{REF}$.

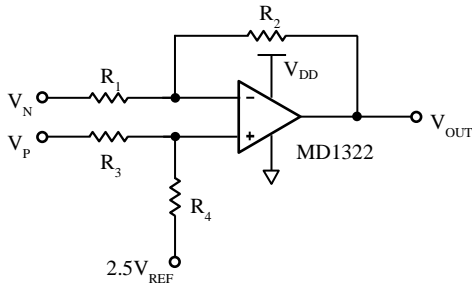

Figure 25. Differential Amplifier

Photodiode Application

The MD1321/2 have very high impedance with an input bias current typically around 10 pA. This characteristic allows the MD1321/2 op amp to be used in photodiode applications and other applications that require high input impedance. Note that the MD1321/2 have significant voltage offset that can be removed by capacitive coupling or software calibration.

Figure 26 illustrates a photodiode or current measurement application. The feedback resistor is limited to 10 MΩ to avoid

excessive output offset. In addition, a resistor is not needed on the noninverting input to cancel bias current offset because the bias current-related output offset is not significant when compared to the voltage offset contribution. For best performance, follow the standard high impedance layout techniques, which include the following:

- Shielding the circuit.
- Cleaning the circuit board.
- Putting a trace connected to the noninverting input around the inverting input.
- Using separate analog and digital power supplies.

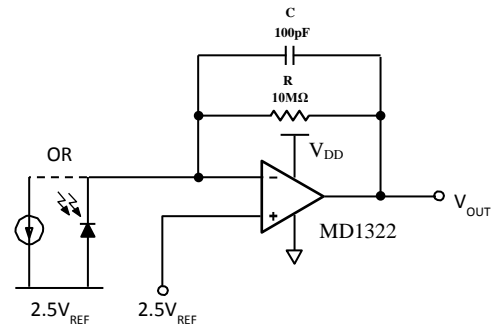
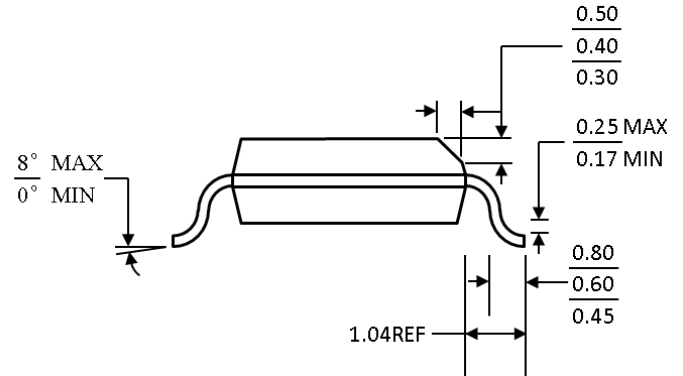
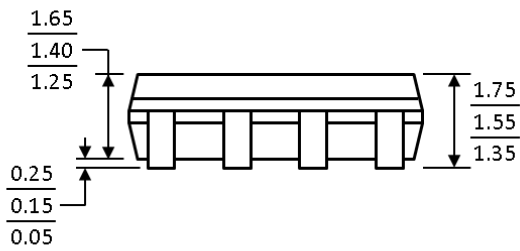
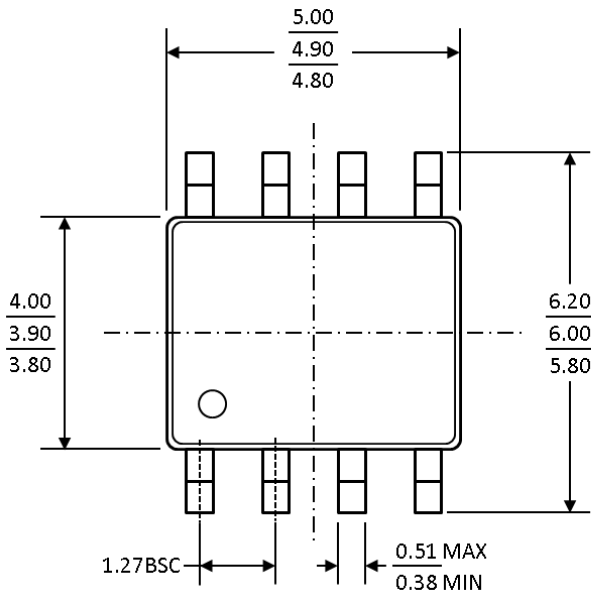

Figure 26. High Input Impedance Application—Photodiode Amplifier

PACKAGE OUTLINE DIMENSIONS



COMPLIANT TO JEDEC STANDARD MS-012-AA

Figure 27 8-Lead Small Outline Package [SOIC]

Dimensions shown in millimeters

PACKAGE OUTLINE DIMENSIONS

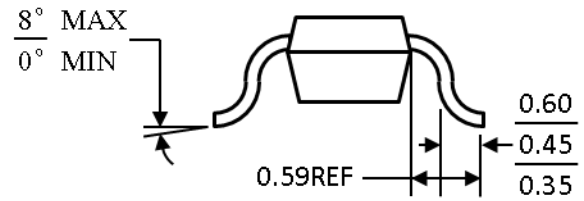
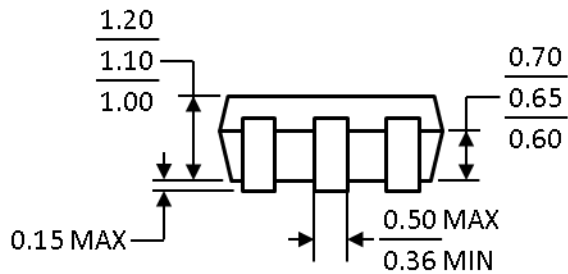
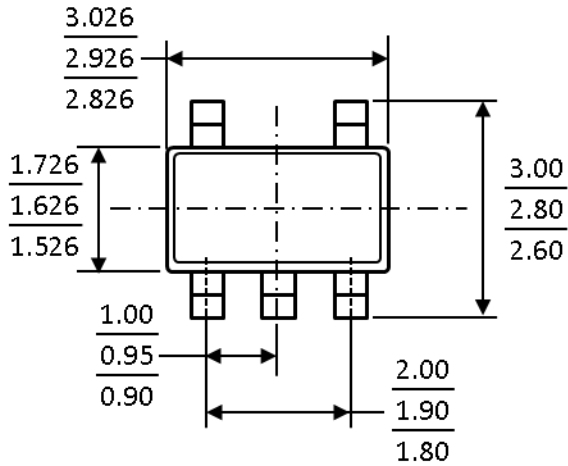

COMPLIANT TO JEDEC STANDARD MO-178-AA

Figure 28 5-Lead Small Outline Transistor Package [SOT-23]

Dimensions shown in millimeters

单击下面可查看定价，库存，交付和生命周期等信息

[>>MingDa\(明达微\)](#)