



2SD1816

NPN PLANAR TRANSISTOR

HIGH CURRENT SWITCHING APPLICATIONS

FEATURES

- * Low collector-to-emitter saturation voltage
- * Good linearity of h_{FE}
- * Small and slim package facilitating compactness of sets.
- * High f_T
- * Fast switching speed

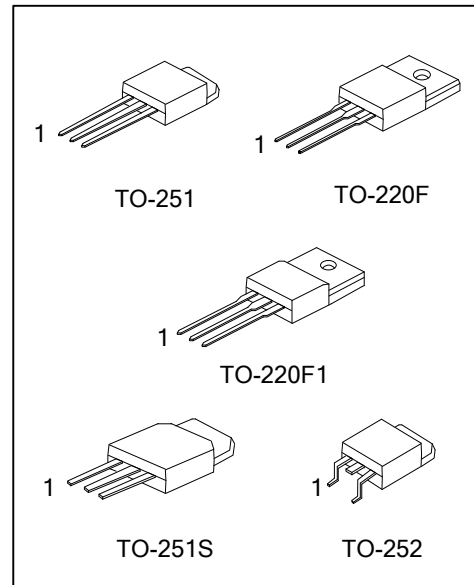

ORDERING INFORMATION

Ordering Number		Package	Pin Assignment			Packing
Lead Free	Halogen Free		1	2	3	
2SD1816L-x-TF1-T	2SD1816G-x-TF1-T	TO-220F1	B	C	E	Tube
2SD1816L-x-TF3-T	2SD1816G-x-TF3-T	TO-220F	B	C	E	Tube
2SD1816L-x-TM3-T	2SD1816G-x-TM3-T	TO-251	B	C	E	Tube
2SD1816L-x-TMS-T	2SD1816G-x-TMS-T	TO-251S	B	C	E	Tube
2SD1816L-x-TN3-R	2SD1816G-x-TN3-R	TO-252	B	C	E	Tape Reel

Note: Pin assignment: B: Base C: Collector E: Emitter

<p>2SD1816G-x-TF3-T</p>	<p>(1) T: Tube, R: Tape Reel (2) TF1: TO-220F1, TF3: TO-220F, TM3: TO-251, TMS: TO-251S, TN3: TO-252 (3) x: refer to Classification of h_{FE1} (4) G: Halogen Free and Lead Free, L: Lead Free</p>
-------------------------	--

MARKING

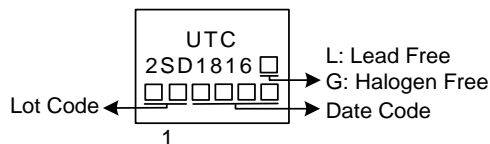

■ ABSOLUTE MAXIMUM RATINGS (T_A=25°C, unless otherwise specified)

PARAMETER		SYMBOL	RATINGS	UNIT
Collector-Base Voltage		V _{CBO}	120	V
Collector-Emitter Voltage		V _{CEO}	100	V
Emitter-Base Voltage		V _{EBO}	6	V
Collector Current	DC	I _C	4	A
	PULSE(Note 2)		8	A
Collector Power Dissipation	TO-251/TO-251S	P _D	1	W
	TO-252			
	TO-220F/TO-220F1		2	W
Junction Temperature		T _J	+150	°C
Storage Temperature		T _{STG}	-40 ~ +150	°C

Notes: 1. Absolute maximum ratings are those values beyond which the device could be permanently damaged. Absolute maximum ratings are stress ratings only and functional device operation is not implied.
 2. Duty=1/2, Pw=20ms.

■ ELECTRICAL CHARACTERISTICS (T_A=25°C, unless otherwise specified)

PARAMETER	SYMBOL	TEST CONDITIONS	MIN	TYP	MAX	UNIT
Collector Base Breakdown Voltage	BV _{CBO}	I _C = 10μA, I _E = 0	120			V
Collector Emitter Breakdown Voltage	BV _{CEO}	I _C = 1mA, R _B = ∞	100			V
Emitter Base Breakdown Voltage	BV _{EBO}	I _E = 10μA, I _C = 0	6			V
Base-Emitter Saturation Voltage	V _{BE(SAT)}	I _C = 2A, I _B = 0.2A		0.9	1.2	V
Collector-Emitter Saturation Voltage	V _{CE(SAT)}	I _C = 2A, I _B = 0.2A		150	400	mV
Collector Cut-Off Current	I _{CBO}	V _{CB} = 100 V, I _E = 0			1	μA
Emitter Cut-Off Current	I _{EBO}	V _{EB} = 4V, I _C = 0			1	μA
DC Current Transfer Ratio	h _{FE1}	V _{CE} = 5V, I _C = 0.5A	70		560	
	h _{FE2}	V _{CE} = 5V, I _C = 3A	40			
Transition Frequency	f _T	V _{CE} = 10V, I _C = 0.5A		180		MHz
Output Capacitance	C _{ob}	V _{CB} = 10V, I _E = 0A, f = 1MHz		40		pF
Turn-on Time	t _{ON}	See test circuit		100		ns
Storage Time	t _{STG}	See test circuit		900		ns
Fall Time	t _F	See test circuit		50		ns

■ CLASSIFICATION of h_{FE1}

RANK	Q	R	S	T	H
RANGE	70 - 140	100 - 200	140 - 280	200 - 400	270 - 560

■ TEST CIRCUIT

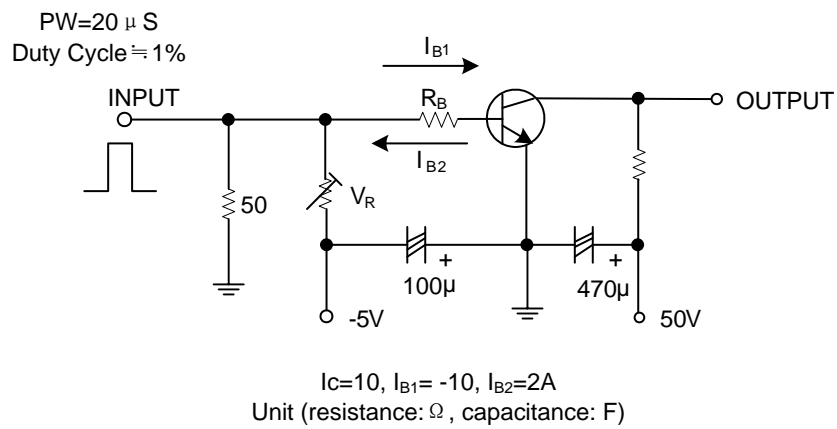

TYPICAL CHARACTERISTICS

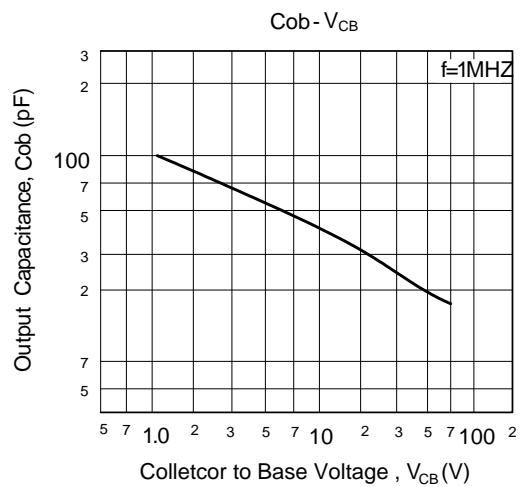
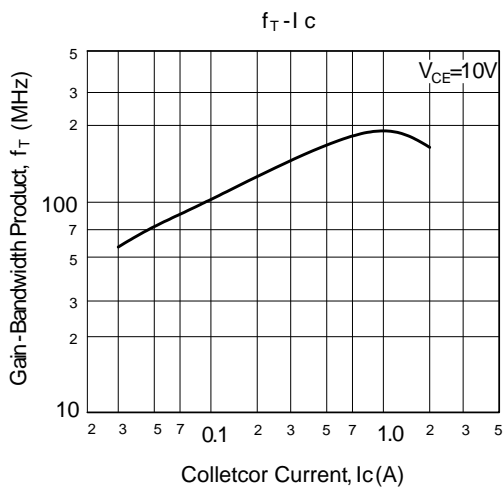
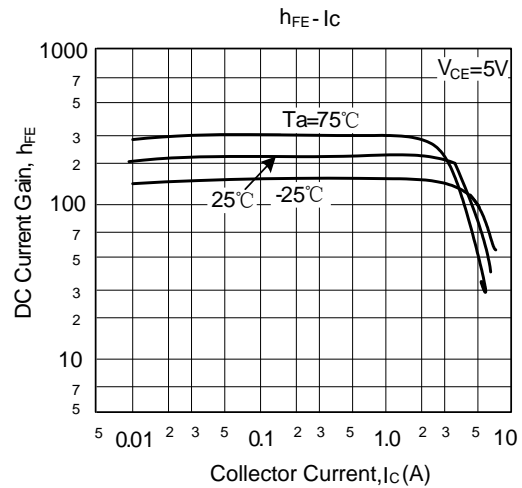
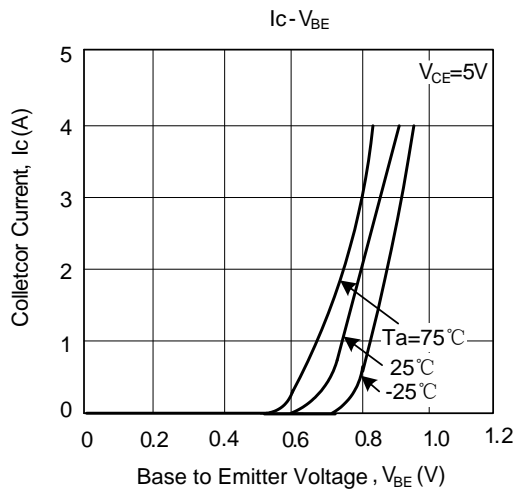
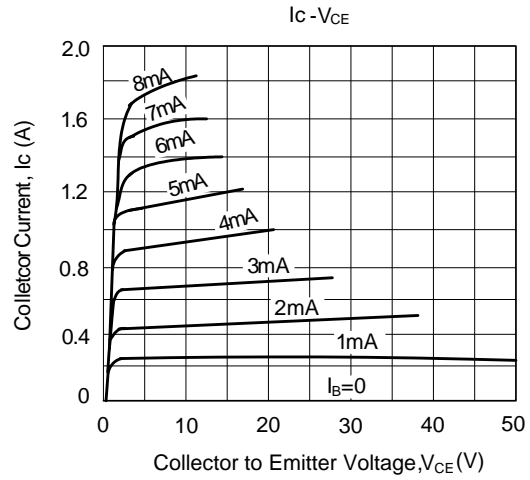
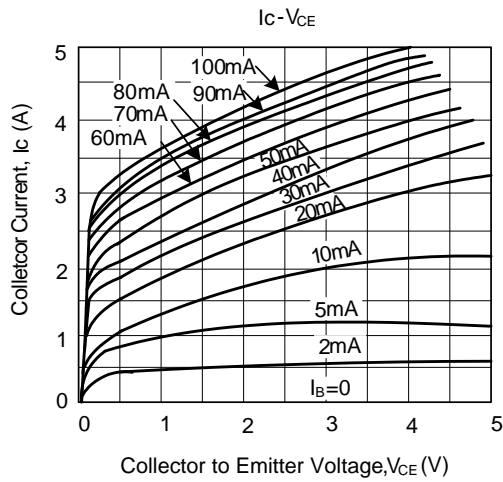

■ TYPICAL CHARACTERISTICS (Cont.)

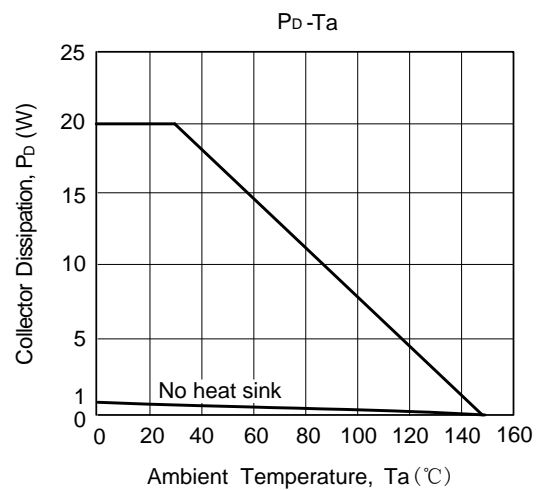
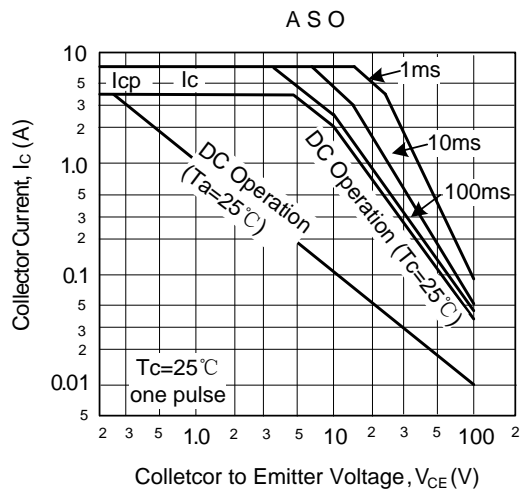
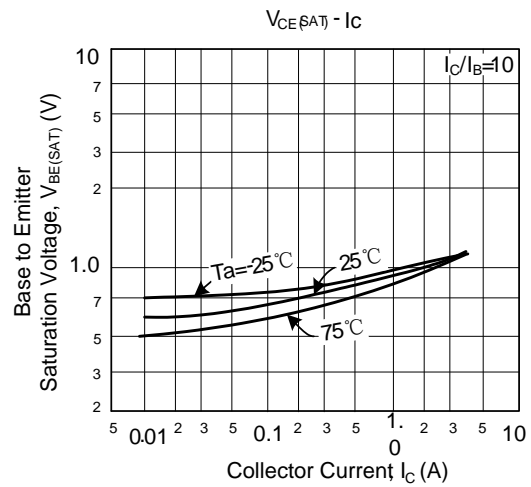
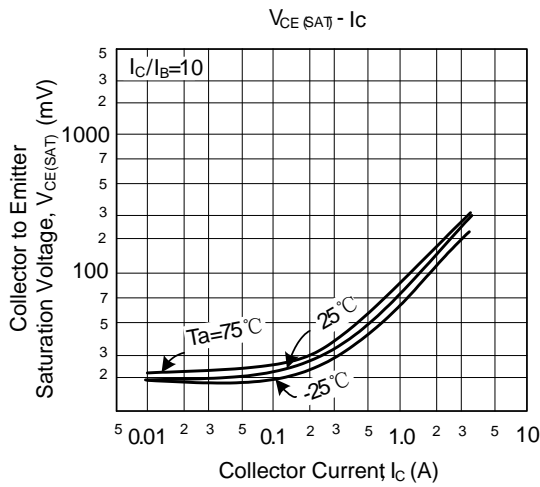

UTC assumes no responsibility for equipment failures that result from using products at values that exceed, even momentarily, rated values (such as maximum ratings, operating condition ranges, or other parameters) listed in products specifications of any and all UTC products described or contained herein. UTC products are not designed for use in life support appliances, devices or systems where malfunction of these products can be reasonably expected to result in personal injury. Reproduction in whole or in part is prohibited without the prior written consent of the copyright owner. UTC reserves the right to make changes to information published in this document, including without limitation specifications and product descriptions, at any time and without notice. This document supersedes and replaces all information supplied prior to the publication hereof.

单击下面可查看定价，库存，交付和生命周期等信息

[>>UTC\(友顺\)](#)