

General Description

These N-Channel enhancement mode power field effect transistors are using trench DMOS technology. This advanced technology has been especially tailored to minimize on-state resistance, provide superior switching performance, and withstand high energy pulse in the avalanche and commutation mode. These devices are well suited for high efficiency fast switching applications.

BVDSS	RDSON	ID
100V	9.2mΩ	12A

Features

- 100V, 12A, $R_{DS(ON)} = 9.2m\Omega @ V_{GS} = 10V$
- Improved dv/dt capability
- Fast switching
- 100% EAS Guaranteed
- Green Device Available

SOP8 Pin Configuration

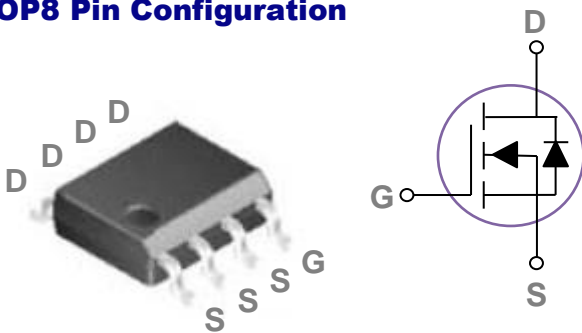

Applications

- Networking
- Load Switch
- LED applications
- Quick Charger

Absolute Maximum Ratings $T_c=25^\circ\text{C}$ unless otherwise noted

Symbol	Parameter	Rating	Units
V_{DS}	Drain-Source Voltage	100	V
V_{GS}	Gate-Source Voltage	+20 / -12	V
I_D	Drain Current – Continuous ($T_c=25^\circ\text{C}$) (Chip Limitation)	12	A
	Drain Current – Continuous ($T_c=100^\circ\text{C}$) (Chip Limitation)	7.6	A
I_{DM}	Drain Current – Pulsed ¹	48	A
EAS	Single Pulse Avalanche Energy ²	211	mJ
IAS	Single Pulse Avalanche Current ²	65	A
V_{SPIKE}	V_{DS} spike voltage ($\leq 100ns$) ⁵	120	V
P_D	Power Dissipation ($T_c=25^\circ\text{C}$)	5	W
	Power Dissipation – Derate above 25°C	0.04	W/ $^\circ\text{C}$
T_{STG}	Storage Temperature Range	-50 to 150	$^\circ\text{C}$
T_J	Operating Junction Temperature Range	-50 to 150	$^\circ\text{C}$

Thermal Characteristics

Symbol	Parameter	Typ.	Max.	Unit
$R_{\theta JA}$	Thermal Resistance Junction to ambient	---	62	$^\circ\text{C}/\text{W}$
$R_{\theta JC}$	Thermal Resistance Junction to Case	---	25	$^\circ\text{C}/\text{W}$

Electrical Characteristics (T_J=25 °C, unless otherwise noted)
Off Characteristics

Symbol	Parameter	Conditions	Min.	Typ.	Max.	Unit
BV _{DSS}	Drain-Source Breakdown Voltage	V _{GS} =0V, I _D =250uA	100	---	---	V
ΔBV _{DSS} /ΔT _J	BV _{DSS} Temperature Coefficient	Reference to 25°C, I _D =1mA	---	0.054	---	V/°C
I _{DSS}	Drain-Source Leakage Current	V _{DS} =100V, V _{GS} =0V, T _J =25°C	---	---	1	uA
		V _{DS} =80V, V _{GS} =0V, T _J =125°C	---	---	10	uA
I _{GSS}	Gate-Source Leakage Current	V _{GS} =+20V, V _{DS} =0V	---	---	100	nA

On Characteristics

R _{DS(ON)}	Static Drain-Source On-Resistance	V _{GS} =10V, I _D =8.5A	---	7.6	9.2	mΩ
		V _{GS} =10V, I _D =8.5A(T _J =125°C)	---	12.5	---	mΩ
		V _{GS} =4.5V, I _D =4A	---	10.8	14	mΩ
V _{GS(th)}	Gate Threshold Voltage	V _{GS} =V _{DS} , I _D =250uA	1.2	1.6	2.5	V
ΔV _{GS(th)}	V _{GS(th)} Temperature Coefficient		---	-5.5	---	mV/°C
g _{fs}	Forward Transconductance	V _{DS} =10V, I _D =3A	---	11	---	S

Dynamic and switching Characteristics

Q _g	Total Gate Charge ^{3, 4}	V _{DS} =50V, V _{GS} =10V, I _D =8.5A	---	37.8	76	nC
Q _{gs}	Gate-Source Charge ^{3, 4}		---	7.8	16	
Q _{gd}	Gate-Drain Charge ^{3, 4}		---	8.4	17	
T _{d(on)}	Turn-On Delay Time ^{3, 4}	V _{DD} =50V, V _{GS} =10V, R _G =6Ω I _D =1A	---	14.6	30	ns
T _r	Rise Time ^{3, 4}		---	21.5	44	
T _{d(off)}	Turn-Off Delay Time ^{3, 4}		---	54	108	
T _f	Fall Time ^{3, 4}		---	84.3	168	
C _{iss}	Input Capacitance	V _{DS} =50V, V _{GS} =0V, F=1MHz	---	2250	4500	pF
C _{oss}	Output Capacitance		---	410	820	
C _{rss}	Reverse Transfer Capacitance		---	25	50	
R _g	Gate resistance	V _{GS} =0V, V _{DS} =0V, F=1MHz	---	1.43	---	Ω

Drain-Source Diode Characteristics and Maximum Ratings

Symbol	Parameter	Conditions	Min.	Typ.	Max.	Unit
I _S	Continuous Source Current	V _G =V _D =0V, Force Current	---	---	12	A
I _{SM}	Pulsed Source Current		---	---	24	A
V _{SD}	Diode Forward Voltage	V _{GS} =0V, I _S =1A, T _J =25°C	---	---	1	V
t _{rr}	Reverse Recovery Time	V _{GS} =0V, I _S =5A, di/dt=100A/μs T _J =25°C	---	47.6	---	nS
Q _{rr}	Reverse Recovery Charge		---	68.3	---	nC

Note :

1. Repetitive Rating : Pulsed width limited by maximum junction temperature.
2. V_{DD}=50V, V_{GS}=10V, L=0.1mH, I_{AS}=65A., R_G=25Ω, Starting T_J=25°C.
3. The data tested by pulsed, pulse width ≤ 300us, duty cycle ≤ 2%.
4. Essentially independent of operating temperature.
5. The spike duty cycle 1% max., limited by T_{J(max)}=125°C

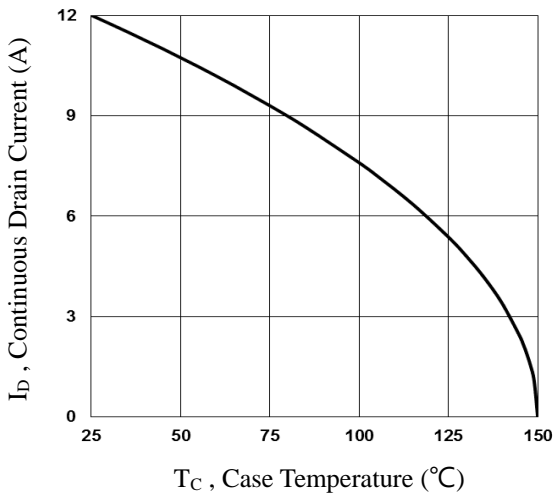

Fig.1 Continuous Drain Current vs. T_C

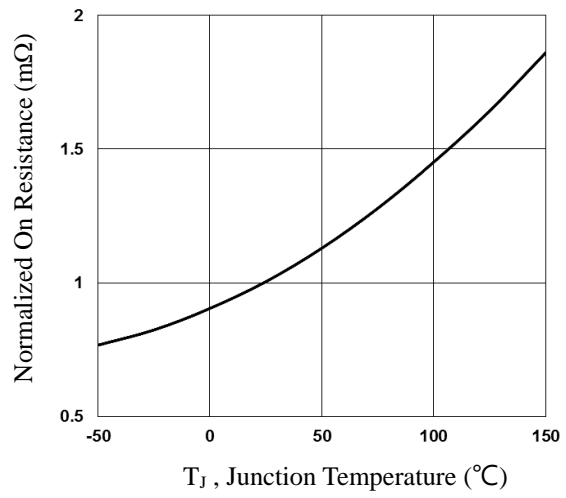

Fig.2 Normalized $R_{DS(on)}$ vs. T_J

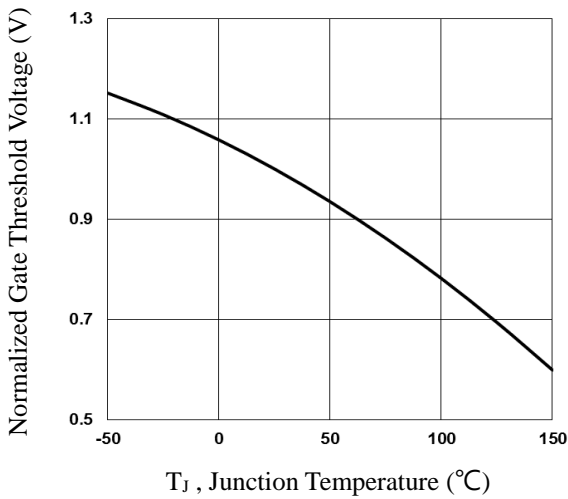

Fig.3 Normalized V_{th} vs. T_J

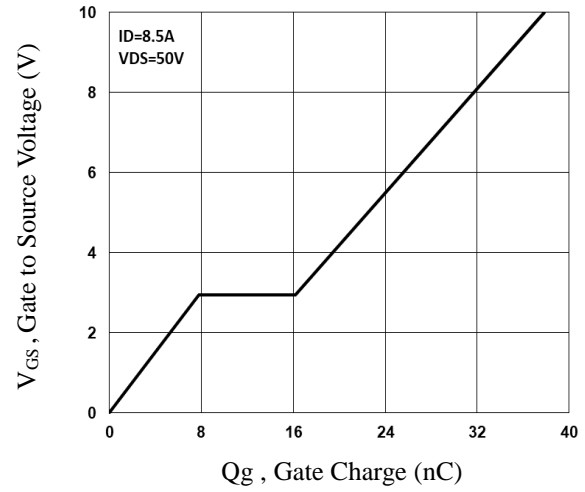

Fig.4 Gate Charge Characteristics

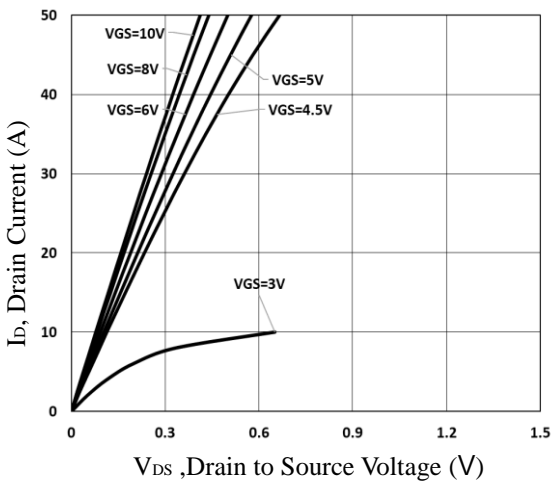

Fig.5 Typical Output Characteristics

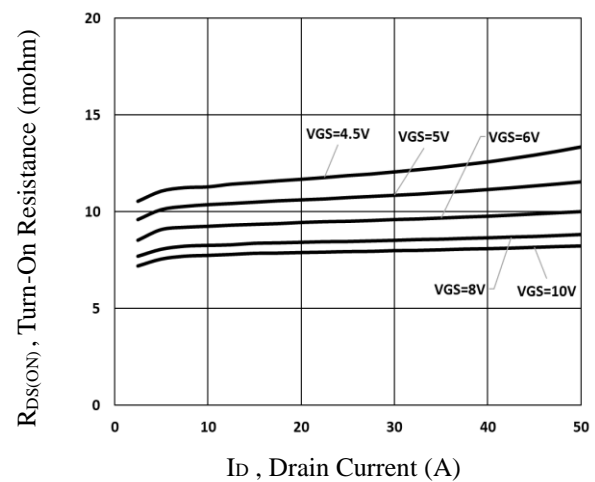

Fig.6 Turn-On Resistance vs. I_D

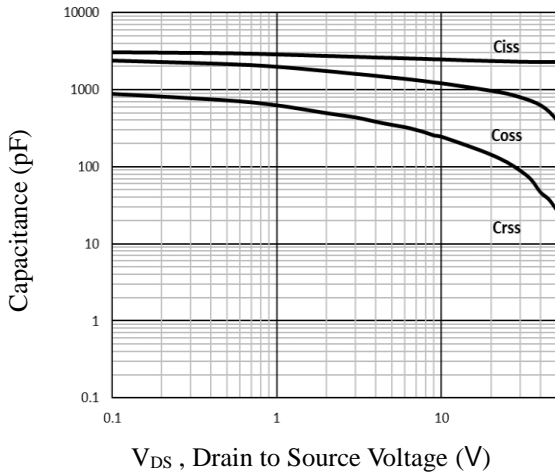

Fig.7 Capacitance Characteristics

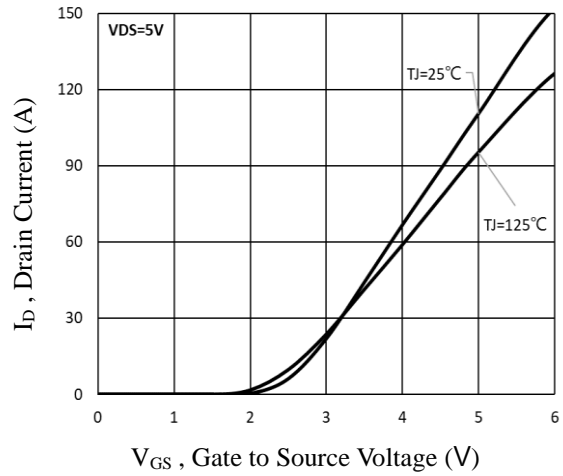

Fig.8 Transfer Characteristics

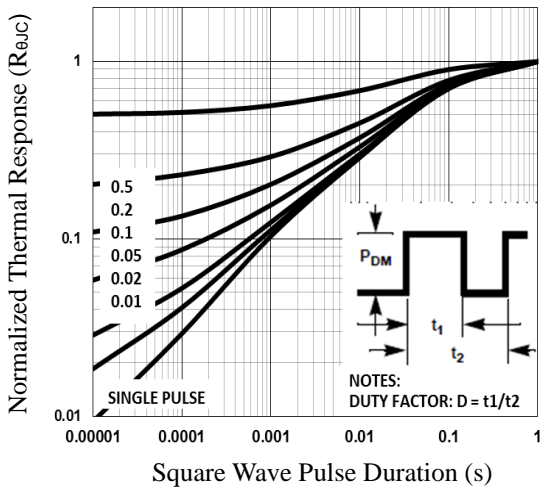

Fig.9 Normalized Transient Impedance

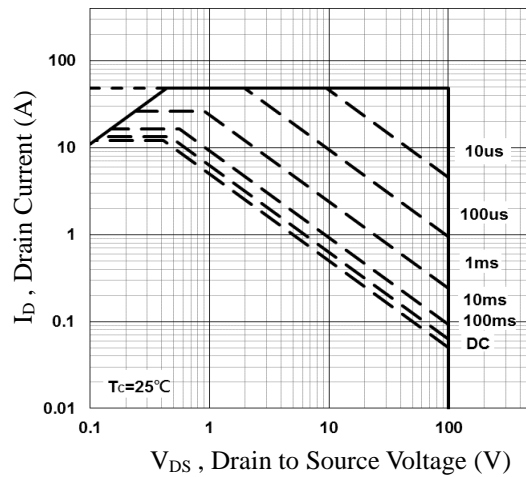

Fig.10 Maximum Safe Operation Area

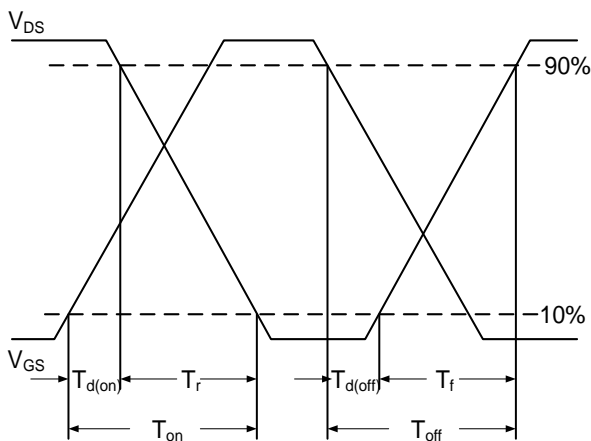

Fig.11 Switching Time Waveform

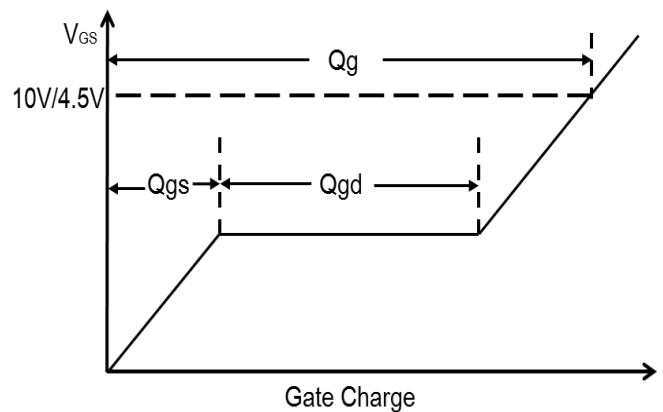
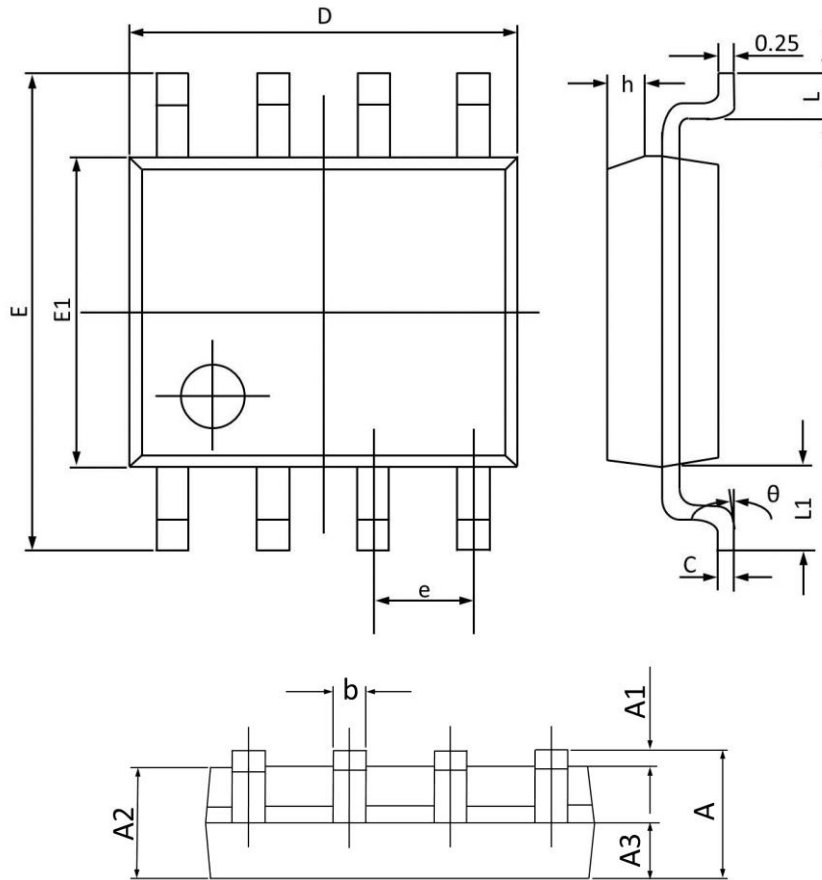

Fig.12 Gate Charge Waveform

SOP8 PACKAGE INFORMATION



Symbol	Dimensions In Millimeters		Dimensions In Inches	
	Min	Max	Min	Max
A	1.350	1.750	0.053	0.069
A1	0.100	0.250	0.004	0.010
A2	1.250	1.650	0.049	0.065
A3	0.500	0.700	0.020	0.028
b	0.380	0.510	0.015	0.020
c	0.170	0.260	0.007	0.010
D	4.700	5.100	0.185	0.201
E	5.800	6.200	0.228	0.244
E1	3.700	4.100	0.146	0.161
e	1.270(BSC)		0.050(BSC)	
h	0.250	0.500	0.010	0.020
L	0.400	0.800	0.016	0.031
L1	1.050(BSC)		0.041(BSC)	
θ	0°	8°	0°	8°

单击下面可查看定价，库存，交付和生命周期等信息

[>>Potens\(博盛\)](#)