

NPN Silicon AF Transistor

- For general AF applications
- High collector current
- High current gain
- Low collector-emitter saturation voltage
- Complementary types:
BC807.../W, BC808.../W (PNP)
- Pb-free (RoHS compliant) package ¹⁾
- Qualified according AEC Q101

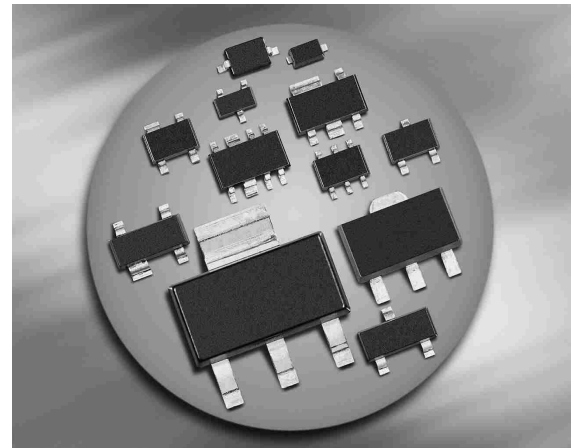

Type	Marking	Pin Configuration						Package
		1 = B	2 = E	3 = C	-	-	-	
BC817-16	6As	1 = B	2 = E	3 = C	-	-	-	SOT23
BC817K-16*	6As	1 = B	2 = E	3 = C	-	-	-	SOT23
BC817-25	6Bs	1 = B	2 = E	3 = C	-	-	-	SOT23
BC817K-25*	6Bs	1 = B	2 = E	3 = C	-	-	-	SOT23
BC817-25W	6Bs	1 = B	2 = E	3 = C	-	-	-	SOT323
BC817K-25W*	6Bs	1 = B	2 = E	3 = C	-	-	-	SOT323
BC817-40	6Cs	1 = B	2 = E	3 = C	-	-	-	SOT23
BC817K-40*	6Cs	1 = B	2 = E	3 = C	-	-	-	SOT23
BC817-40W	6Cs	1 = B	2 = E	3 = C	-	-	-	SOT323
BC817K-40W*	6Cs	1 = B	2 = E	3 = C	-	-	-	SOT323
BC818-16W	6Es	1 = B	2 = E	3 = C	-	-	-	SOT323
BC818K-16W*	6Es	1 = B	2 = E	3 = C	-	-	-	SOT323
BC818-25	6Fs	1 = B	2 = E	3 = C	-	-	-	SOT23
BC818K-25*	6Fs	1 = B	2 = E	3 = C	-	-	-	SOT23
BC818-40	6Gs	1 = B	2 = E	3 = C	-	-	-	SOT23
BC818K-40*	6Gs	1 = B	2 = E	3 = C	-	-	-	SOT23

* Shrinked chip version

¹⁾Pb-containing package may be available upon special request

Maximum Ratings

Parameter	Symbol	Value	Unit	
Collector-emitter voltage BC817... BC818...	V_{CEO}	45 25	V	
Collector-base voltage BC817... BC818...	V_{CBO}	50 30		
Emitter-base voltage	V_{EBO}	5		
Collector current	I_C	500	mA	
Peak collector current	I_{CM}	1000		
Base current	I_B	100		
Peak base current	I_{BM}	200		
Total power dissipation- $T_S \leq 79\text{ °C}$, BC817, BC818 $T_S \leq 115\text{ °C}$, BC817K, BC818K $T_S \leq 130\text{ °C}$, BC817W/KW, BC818...W/KW	P_{tot}	330 500 250	mW	
Junction temperature	T_j	150		°C
Storage temperature	T_{stg}	-65 ... 150		

Thermal Resistance

Parameter	Symbol	Value	Unit
Junction - soldering point ¹⁾ BC817, BC818 BC817K, BC818K BC817W/KW, BC818W/KW	R_{thJS}	≤ 215 ≤ 70 ≤ 80	K/W

¹For calculation of R_{thJA} please refer to Application Note Thermal Resistance

Electrical Characteristics at $T_A = 25^\circ\text{C}$, unless otherwise specified

Parameter	Symbol	Values			Unit
		min.	typ.	max.	
DC Characteristics					
Collector-emitter breakdown voltage $I_C = 10\text{ mA}$, $I_B = 0$, BC817... $I_C = 10\text{ mA}$, $I_B = 0$, BC818...	$V_{(BR)CEO}$	45 25	- -	- -	V
Collector-base breakdown voltage $I_C = 10\text{ }\mu\text{A}$, $I_E = 0$, BC817... $I_C = 10\text{ }\mu\text{A}$, $I_E = 0$, BC818...	$V_{(BR)CBO}$	50 30	- -	- -	-
Emitter-base breakdown voltage $I_E = 10\text{ }\mu\text{A}$, $I_C = 0$	$V_{(BR)EBO}$	5	-	-	V
Collector-base cutoff current $V_{CB} = 25\text{ V}$, $I_E = 0$ $V_{CB} = 25\text{ V}$, $I_E = 0$, $T_A = 150^\circ\text{C}$	I_{CBO}	- -	- -	0.1 50	μA
Emitter-base cutoff current $V_{EB} = 4\text{ V}$, $I_C = 0$	I_{EBO}	-	-	100	nA
DC current gain ¹⁾ $I_C = 100\text{ mA}$, $V_{CE} = 1\text{ V}$, $h_{FE}\text{-grp.16}$ $I_C = 100\text{ mA}$, $V_{CE} = 1\text{ V}$, $h_{FE}\text{-grp.25}$ $I_C = 100\text{ mA}$, $V_{CE} = 1\text{ V}$, $h_{FE}\text{-grp.40}$ $I_C = 300\text{ mA}$, $V_{CE} = 1\text{ V}$, $h_{FE}\text{-grp.16}^{2)}$ $I_C = 300\text{ mA}$, $V_{CE} = 1\text{ V}$, $h_{FE}\text{-grp.25}^{2)}$ $I_C = 300\text{ mA}$, $V_{CE} = 1\text{ V}$, $h_{FE}\text{-grp.40}^{2)}$ $I_C = 500\text{ mA}$, $V_{CE} = 1\text{ V}$, all $h_{FE}\text{-grps.}^{3)}$	h_{FE}	100 160 250 60 100 170 40	160 250 350 - - - -	250 400 630 - - - -	-
Collector-emitter saturation voltage ¹⁾ $I_C = 500\text{ mA}$, $I_B = 50\text{ mA}$	V_{CEsat}	-	-	0.7	V
Base emitter saturation voltage ¹⁾ $I_C = 500\text{ mA}$, $I_B = 50\text{ mA}$	V_{BEsat}	-	-	1.2	

¹⁾Pulse test: $t < 300\mu\text{s}$; $D < 2\%$
²⁾For all BC817 and BC818 subtypes

³⁾For all BC817K and BC818K subtypes

Electrical Characteristics at $T_A = 25^\circ\text{C}$, unless otherwise specified

Parameter	Symbol	Values			Unit
		min.	typ.	max.	
AC Characteristics					
Transition frequency $I_C = 50\text{ mA}$, $V_{CE} = 5\text{ V}$, $f = 100\text{ MHz}$	f_T	-	170	-	MHz
Collector-base capacitance $V_{CB} = 10\text{ V}$, $f = 1\text{ MHz}^1$ $V_{CB} = 10\text{ V}$, $f = 1\text{ MHz}^2$	C_{cb}	-	6 3	-	pF
Emitter-base capacitance $V_{EB} = 0.5\text{ V}$, $f = 1\text{ MHz}^1$ $V_{EB} = 0.5\text{ V}$, $f = 1\text{ MHz}^2$	C_{eb}	-	60 40	-	

¹For all BC817 and BC818 subtypes

²For all BC817K and BC818K subtypes

DC current gain $h_{FE} = f(I_C)$

$V_{CE} = 1\text{ V}$

$h_{FE}\text{-grp.16}$

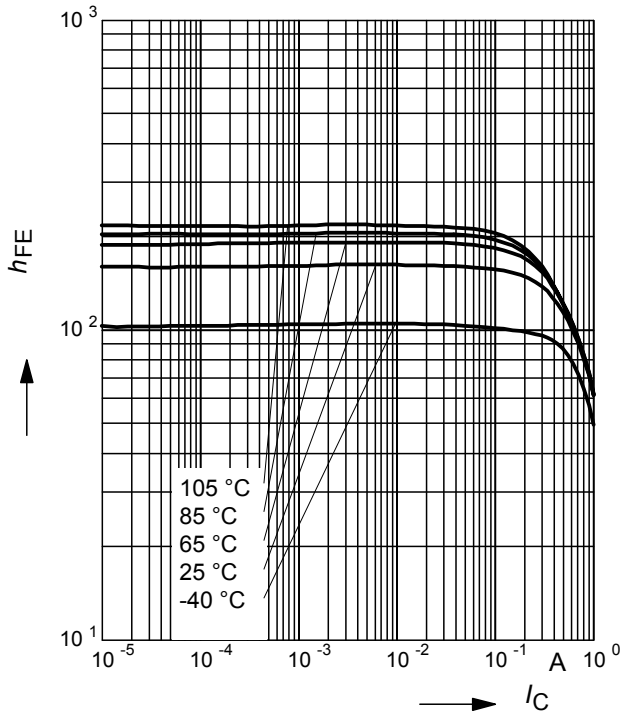

DC current gain $h_{FE} = f(I_C)$

$V_{CE} = 1\text{ V}$

$h_{FE}\text{-grp.25}$

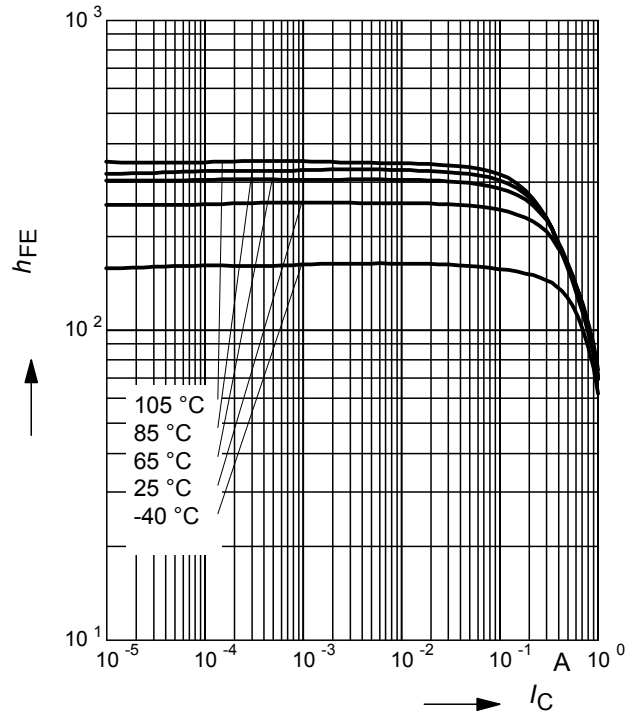

DC current gain $h_{FE} = f(I_C)$

$V_{CE} = 1\text{ V}$

$h_{FE}\text{-grp.40}$

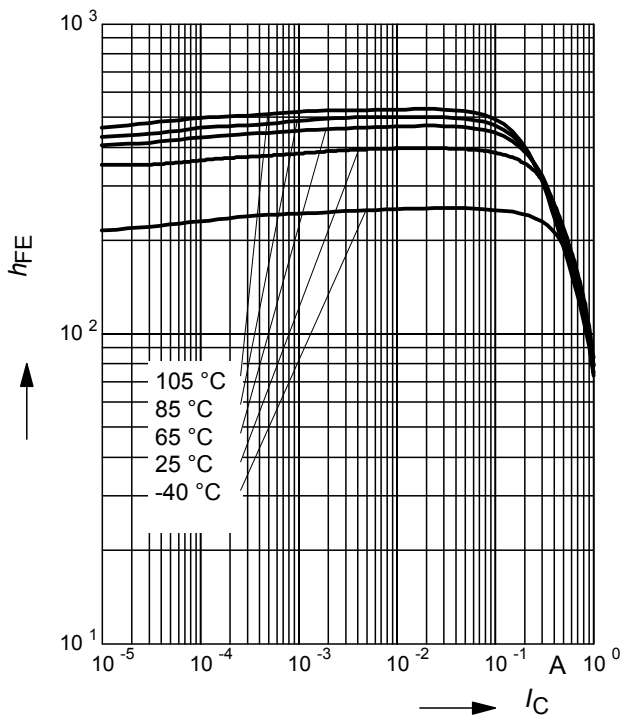

Collector-emitter saturation voltage

$I_C = f(V_{CEsat}), h_{FE} = 10$

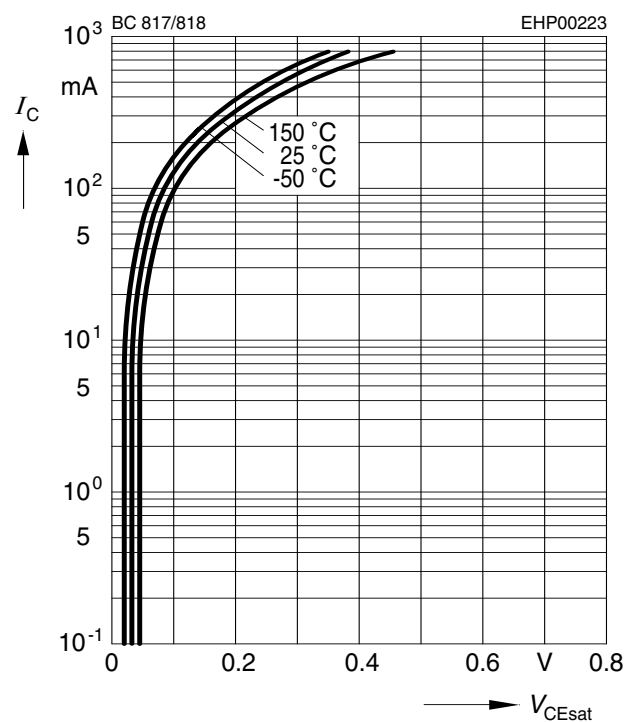

Base-emitter saturation voltage

$I_C = f(V_{BEsat}), h_{FE} = 10$

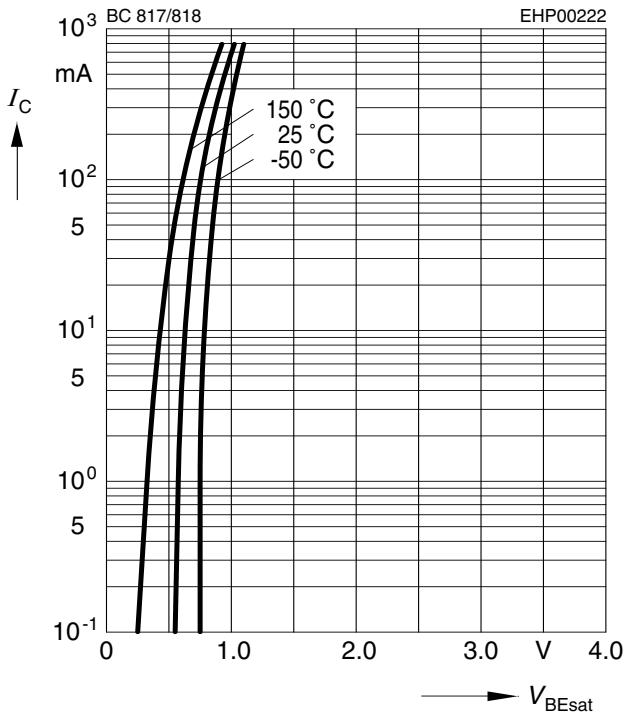

Collector cutoff current $I_{CBO} = f(T_A)$

$V_{CBO} = 25 V$

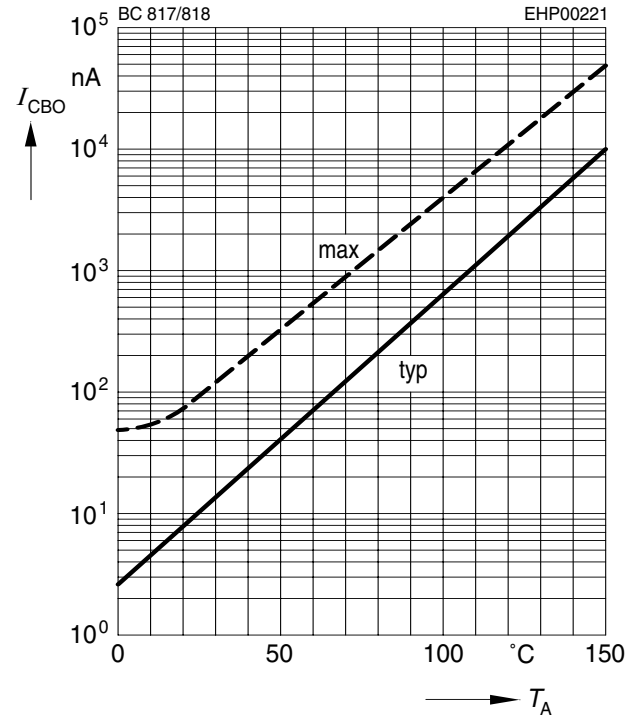

Transition frequency $f_T = f(I_C)$

$V_{CE} = \text{parameter in V}, f = 2 \text{ GHz}$

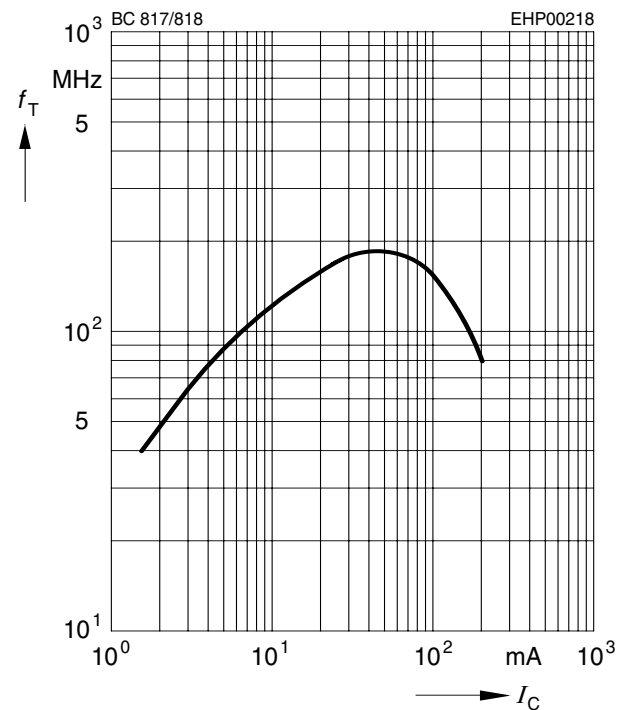

Collector-base capacitance $C_{cb} = f(V_{CB})$

Emitter-base capacitance $C_{eb} = f(V_{EB})$

BC817, BC818: - - - , BC817K, BC818K: —

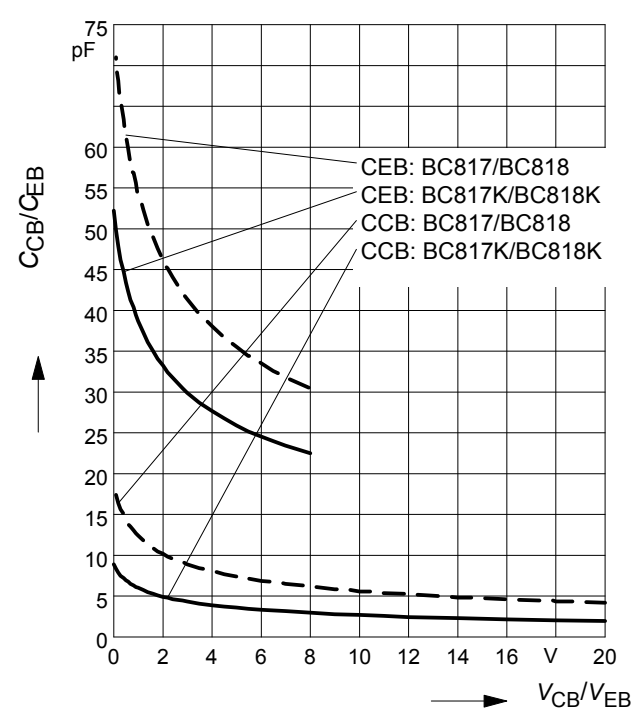

Total power dissipation $P_{tot} = f(T_S)$

BC817, BC818: - - - , BC817K, BC818K: —

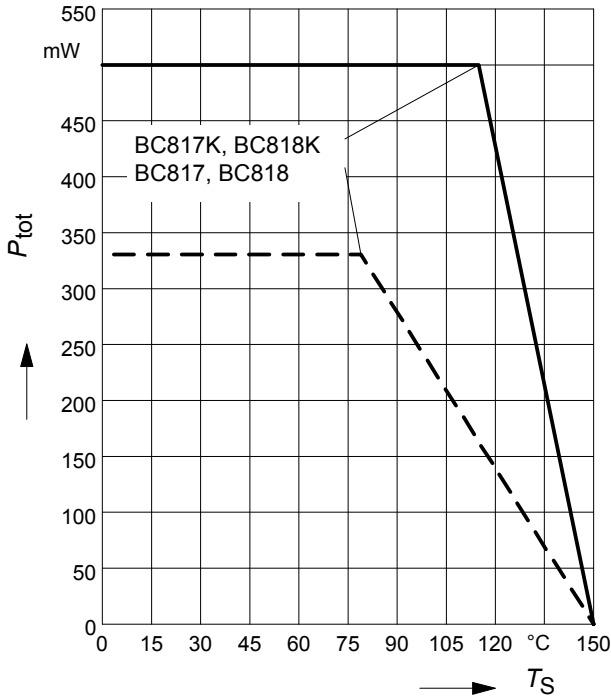

Total power dissipation $P_{tot} = f(T_S)$

BC817W/KW, BC818W/KW

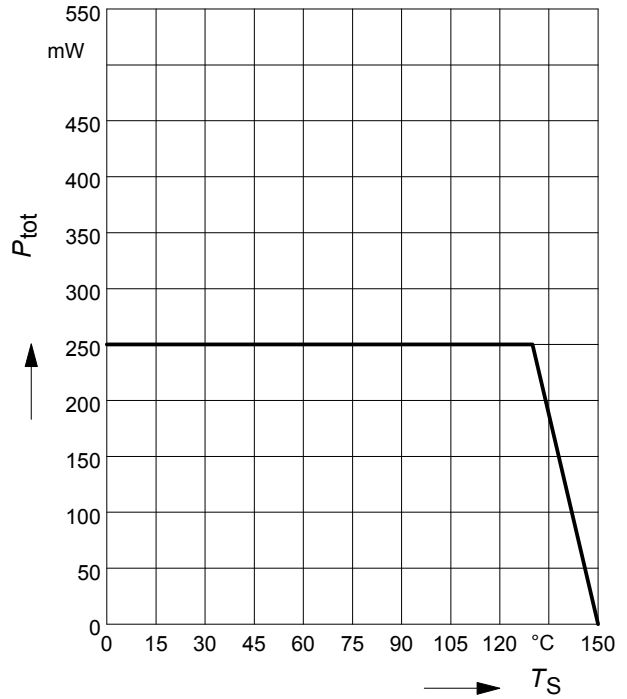

Permissible Pulse Load $R_{thJS} = f(t_p)$

BC817, BC818

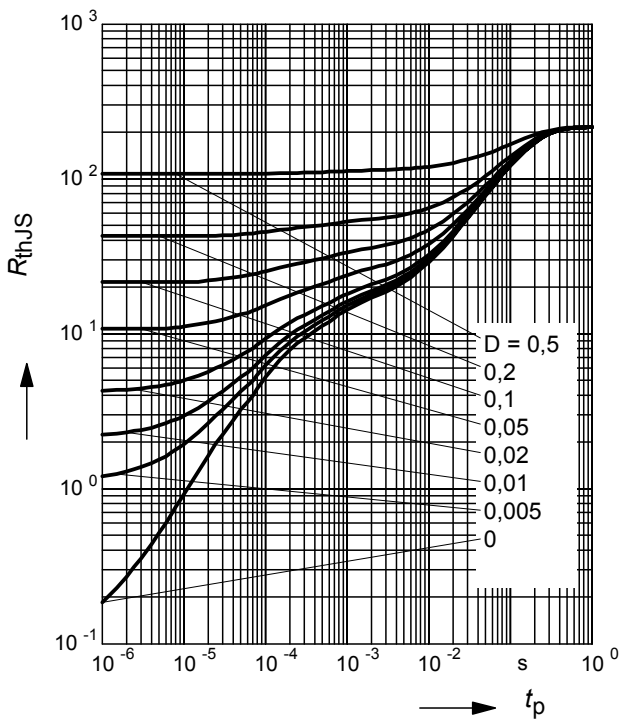

Permissible Pulse Load

$P_{totmax}/P_{totDC} = f(t_p)$

BC817, BC818

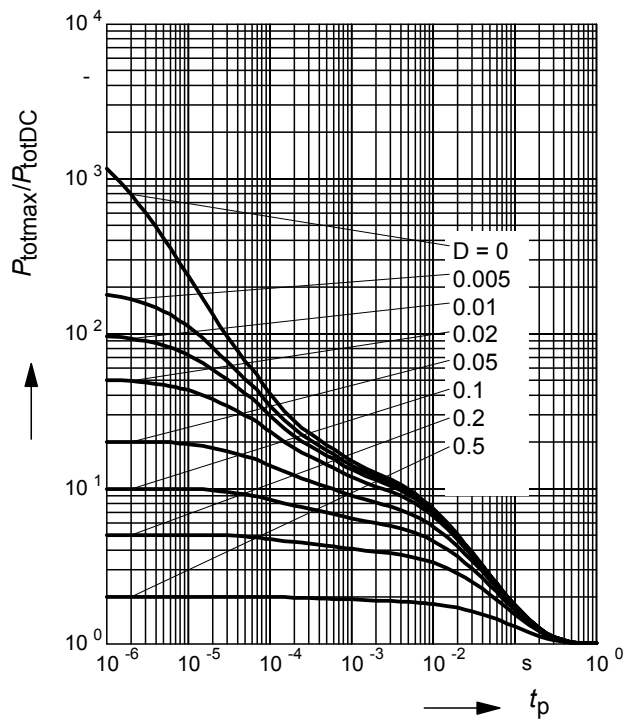

Permissible Pulse Load $R_{thJS} = f(t_p)$

BC817/K, BC818/K

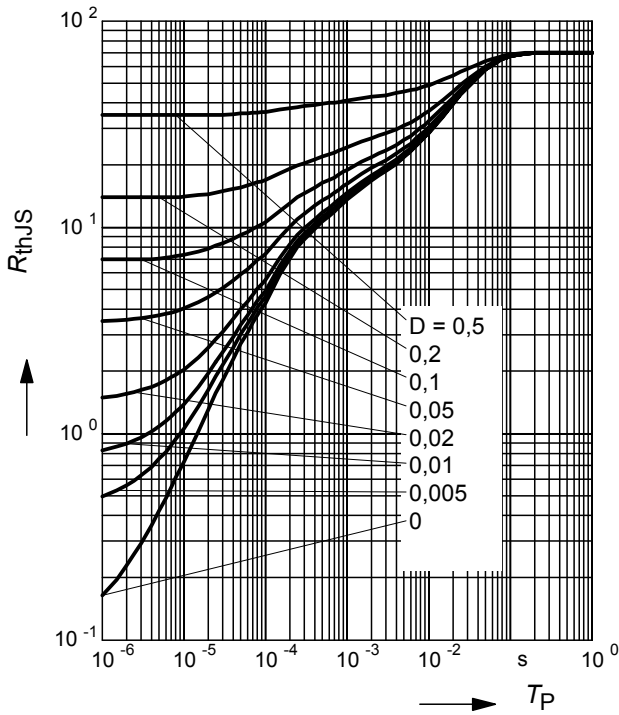

Permissible Pulse Load

$P_{totmax}/P_{totDC} = f(t_p)$

BC817K, BC818K

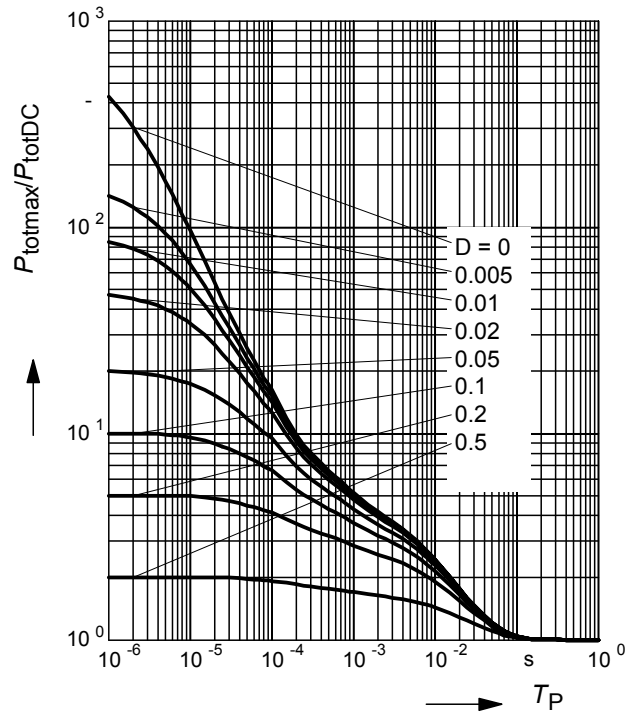

Permissible Puls Load $R_{thJS} = f(t_p)$

BC817W/KW, BC818W/KW

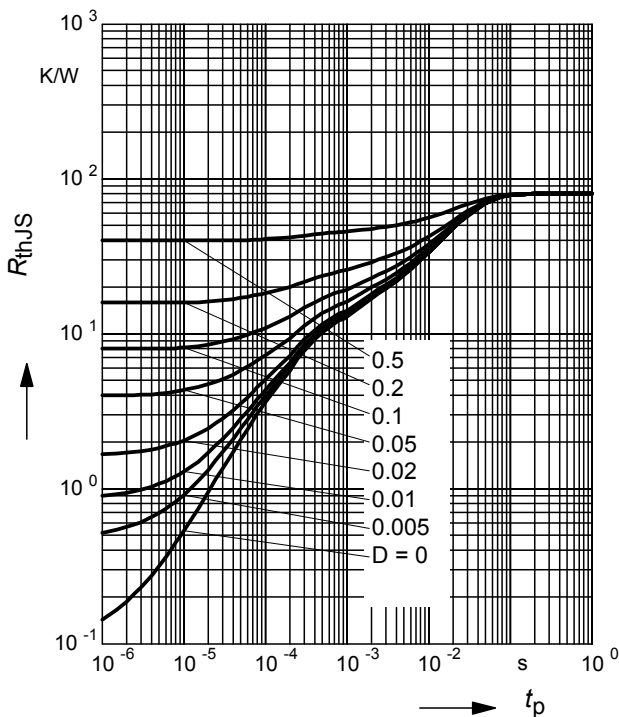

Permissible Pulse Load

$P_{totmax}/P_{totDC} = f(t_p)$

BC817W/KW, BC818W/KW

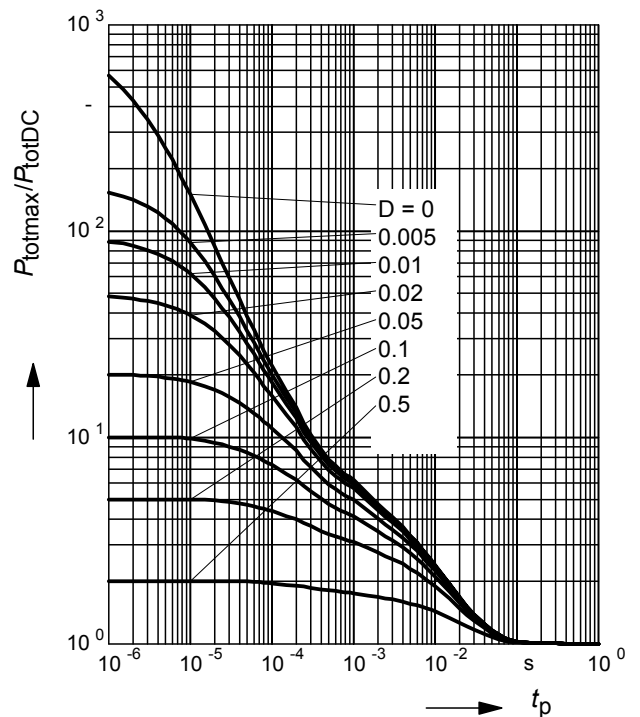

Package Outline

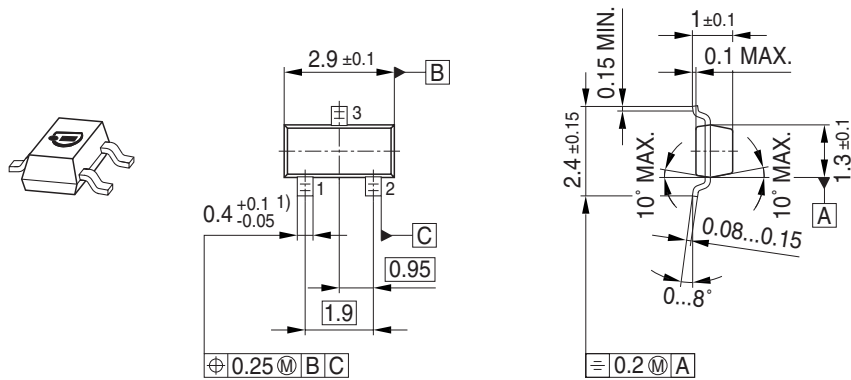

1) Lead width can be 0.6 max. in dambar area

Foot Print

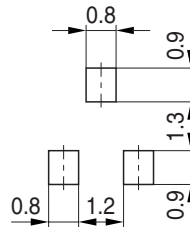

Marking Layout (Example)

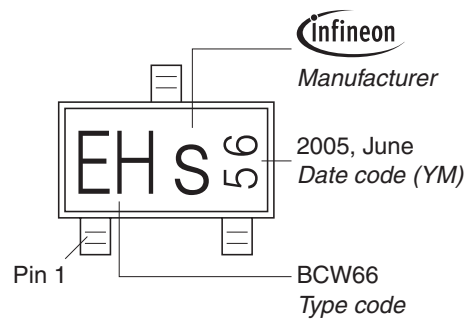

Standard Packing

Reel ϕ 180 mm = 3.000 Pieces/Reel
 Reel ϕ 330 mm = 10.000 Pieces/Reel

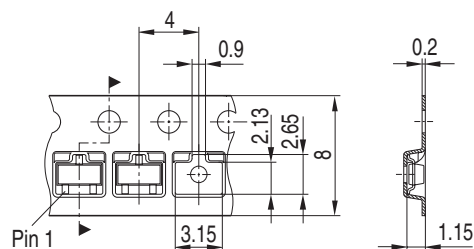

Package Outline

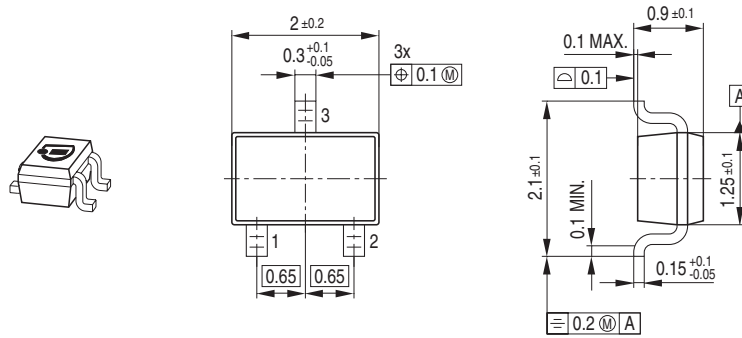

Foot Print

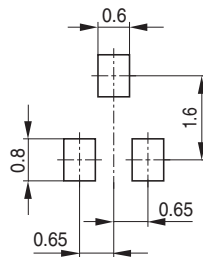

Marking Layout (Example)

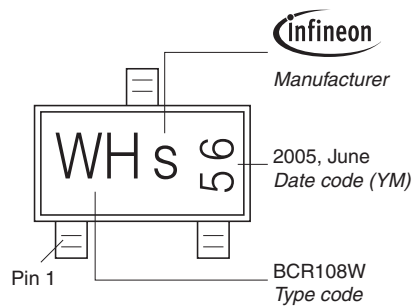

Standard Packing

Reel \varnothing 180 mm = 3.000 Pieces/Reel
 Reel \varnothing 330 mm = 10.000 Pieces/Reel

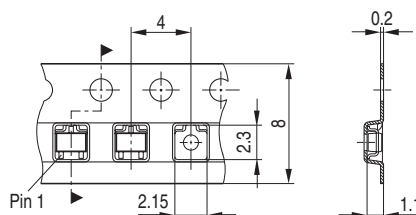

Edition 2006-02-01

Published by

Infineon Technologies AG

81726 München, Germany

© Infineon Technologies AG 2007.

All Rights Reserved.

Attention please!

The information given in this dokument shall in no event be regarded as a guarantee of conditions or characteristics ("Beschaffenheitsgarantie"). With respect to any examples or hints given herein, any typical values stated herein and/or any information regarding the application of the device, Infineon Technologies hereby disclaims any and all warranties and liabilities of any kind, including without limitation warranties of non-infringement of intellectual property rights of any third party.

Information

For further information on technology, delivery terms and conditions and prices please contact your nearest Infineon Technologies Office (www.infineon.com).

Warnings

Due to technical requirements components may contain dangerous substances. For information on the types in question please contact your nearest Infineon Technologies Office.

Infineon Technologies Components may only be used in life-support devices or systems with the express written approval of Infineon Technologies, if a failure of such components can reasonably be expected to cause the failure of that life-support device or system, or to affect the safety or effectiveness of that device or system.

Life support devices or systems are intended to be implanted in the human body, or to support and/or maintain and sustain and/or protect human life. If they fail, it is reasonable to assume that the health of the user or other persons may be endangered.

单击下面可查看定价，库存，交付和生命周期等信息

[>>Infineon Technologies\(英飞凌\)](#)