

## 4-CHANNEL LOW CAPACITANCE ESD PROTECTION DIODES ARRAY

### DESCRIPTIONS

The LRC099-04BT1G is a 4-channel ultra low capacitance rail clamp ESD protection diodes array. Each channel consists of a pair of ESD diodes that steer positive or negative ESD current to either the positive or negative rail. A zener diode is integrated in to the array between the positive and negative supply rails. In the typical applications, the negative rail pin (assigned as GND) is connected with system ground. The Positive ESD current is steered to the ground through an ESD diode and Zener diode and the positive ESD voltage is clamped to the zener voltage. The LRC099-04BT1G is idea to protect high speed data lines. Three package type is provided for easy PCB layout.

**LRC099-04BT1G**  
**S-LRC099-04BT1G**

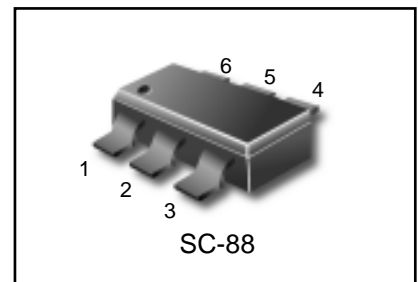

### FEATURES

- \* 4 channels of ESD protection;
- \* Provides ESD protection to IEC61000-4-2 level 4
  - $\pm 15$ kV air discharge
  - $\pm 8$ kV contact discharge;
- \* Channel I/O to GND capacitance: 0.9pF(Max)
- \* Channel I/O to I/O capacitance: 0.45pF(Max)
- \* Low clamping voltage;
- \* Low operating voltage;
- \* Improved zener structure;
- \* Optimized package for easy high speed data lines PCB layout;
- \* RoHS compliant.
- \* S- Prefix for Automotive and Other Applications Requiring Unique Site and Control Change Requirements; AEC-Q101 Qualified and PPAP Capable.

### APPLICATIONS

- \* HDMI / DVI ports;
- \* Display Port interface;
- \* 10M / 100M / 1G Ethernet;
- \* USB 2.0 interface;
- \* VGA interface
- \* Set-top box;
- \* Flat panel Monitors / TVs;
- \* PC / Note book

### ORDERING INFORMATION

| Part No.                         | Package | Marking | Material     | Shipping      |
|----------------------------------|---------|---------|--------------|---------------|
| LRC099-04BT1G<br>S-LRC099-04BT1G | SC-88   | C96     | Halogen Free | 3000Tape&Reel |

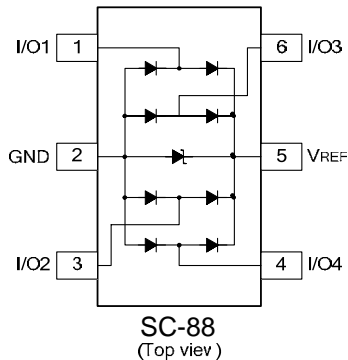
**LRC099-04BT1G , S-LRC099-04BT1G**
**PIN CONFIGURATION**

**ABSOLUTE MAXIMUM RATINGS**

| Characteristics                  | Symbol            | Ratings     | Unit         |
|----------------------------------|-------------------|-------------|--------------|
| Peak Pulse Power(8/20 $\mu$ s)   | P <sub>PP</sub>   | 150         | W            |
| Peak Pulse Current(8/20 $\mu$ s) | I <sub>PP</sub>   | 5           | A            |
| ESD per IEC 61000-4-2(Air)       | V <sub>ESD1</sub> | $\pm 15$ kV | kV           |
| ESD per IEC 61000-4-2(Contact)   | V <sub>ESD2</sub> | $\pm 8$ kV  | kV           |
| Operating Temperature Range      | T <sub>opr</sub>  | -55 ~ +125  | $^{\circ}$ C |
| Storage Temperature Range        | T <sub>stg</sub>  | -55 ~ +150  | $^{\circ}$ C |

**ELECTRICAL CHARACTERISTICS(T<sub>amb</sub>=25 $^{\circ}$ C)**

| Characteristics                          | Symbol           | Test Conditions   | Min. | Typ. | Max. | Unit    |
|--|------------------|---|------|------|------|---------|
| Reverse Working Voltage                  | V <sub>RWM</sub> | Any I/O pin to GND  |      |      | 5    | V       |
| Reverse Breakdown Voltage                | V <sub>BR</sub>  | I <sub>T</sub> =1mA;<br>Any I/O pin to GND  | 6    |      |      | V       |
| Reverse Leakage Current                  | I <sub>R</sub>   | V <sub>RWM</sub> =5V, T=25 $^{\circ}$ C;<br>Any I/O pin to GND                              |      |      | 1    | $\mu$ A |
| Positive Clamping Voltage                | V <sub>C1</sub>  | I <sub>PP</sub> =1A, t <sub>p</sub> =8/20 $\mu$ s;<br>Positive pulse;<br>Any I/O pin to GND |      | 8.5  | 12.0 | V       |
| Negative Clamping Voltage                | V <sub>C2</sub>  | I <sub>PP</sub> =1A, t <sub>p</sub> =8/20 $\mu$ s;<br>Negative pulse;<br>Any I/O pin to GND |      | 1.8  |      | V       |
| Junction Capacitance Between Channel     | C <sub>J1</sub>  | V <sub>R</sub> =0V, f=1MHz;<br>Between I/O pins   |      | 0.35 | 0.45 | pF      |
| Junction Capacitance Between I/O And GND | C <sub>J2</sub>  | V <sub>R</sub> =0V, f=1MHz;<br>Any I/O pin to GND   |      |      | 0.9  | pF      |

LRC099-04BT1G , S-LRC099-04BT1G

TYPICAL ELECTRICAL CHARACTERISTICS CURVE

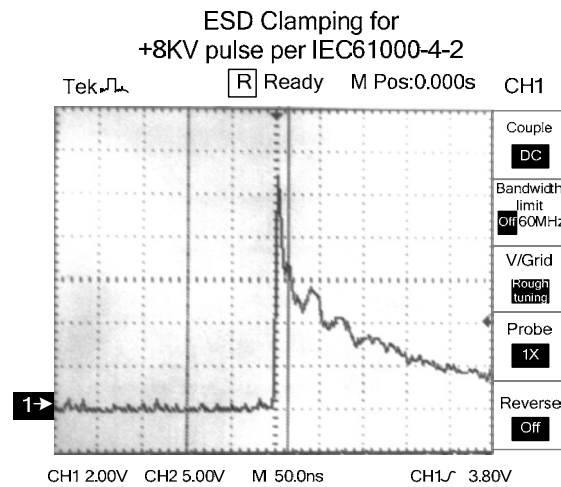
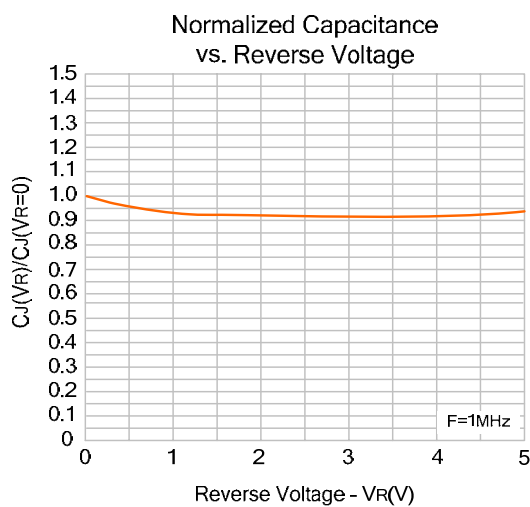
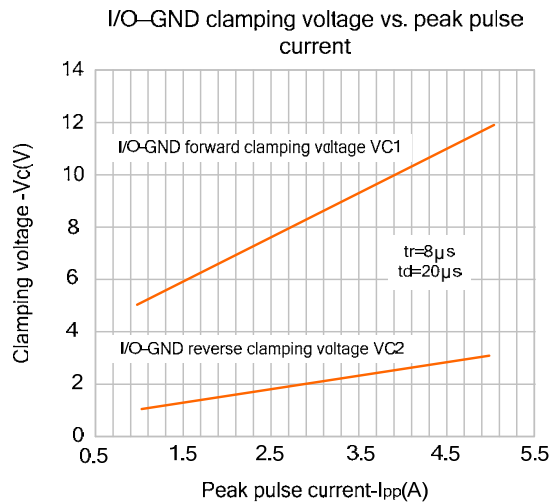
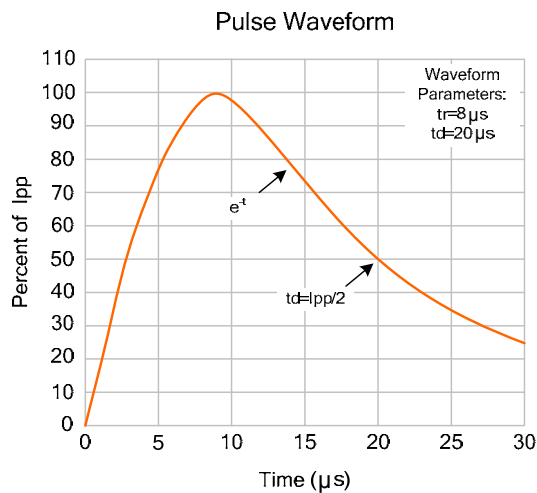
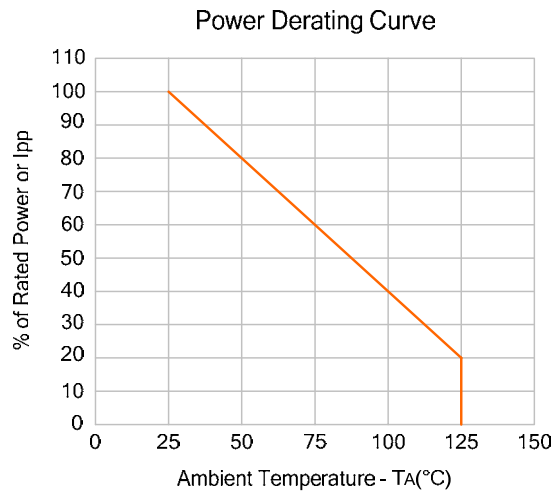
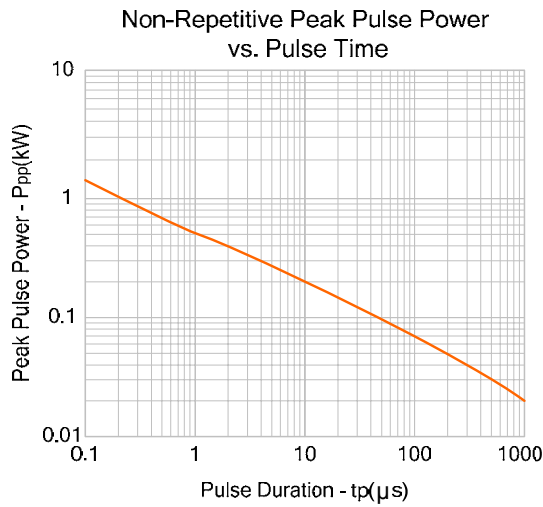

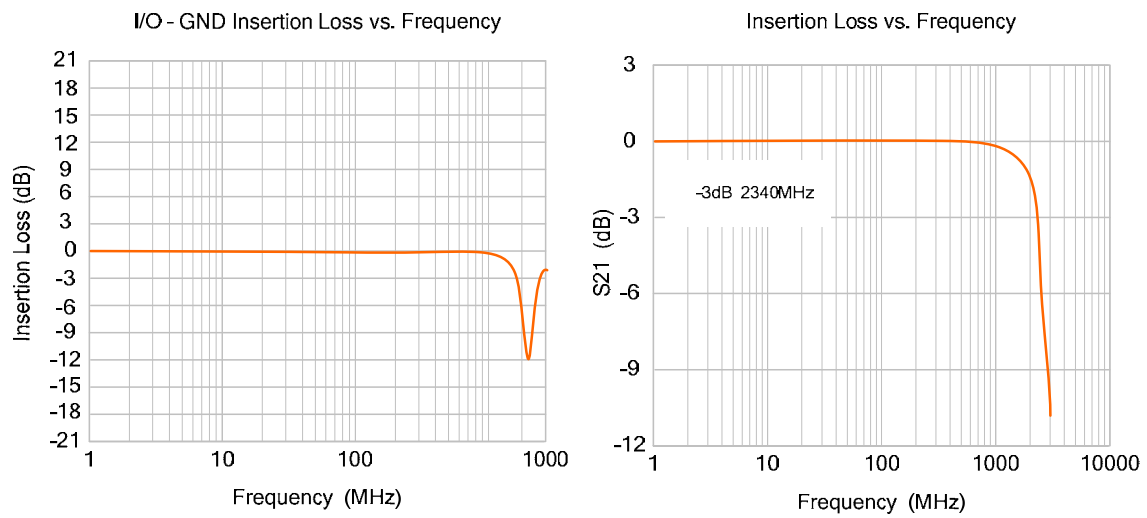
**LRC099-04BT1G , S-LRC099-04BT1G****TYPICAL ELECTRICAL CHARACTERISTICS CURVE**

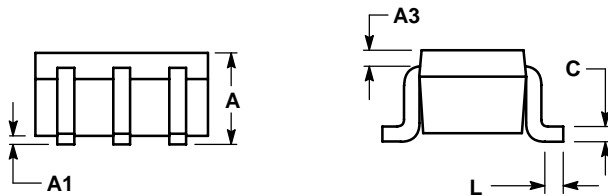
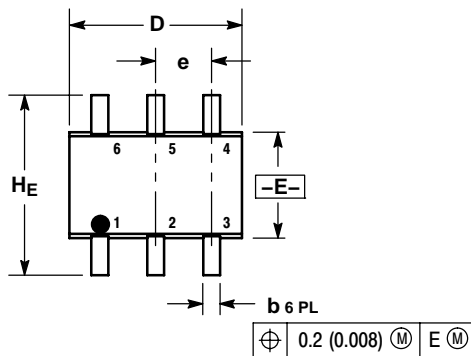
**LRC099-04BT1G , S-LRC099-04BT1G**
**SC-88/SOT-363**

**NOTES:**

1. DIMENSIONING AND TOLERANCING PER ANSI Y14.5M, 1982.
2. CONTROLLING DIMENSION: INCH.
3. 419B-01 OBSOLETE, NEW STANDARD 419B-02.

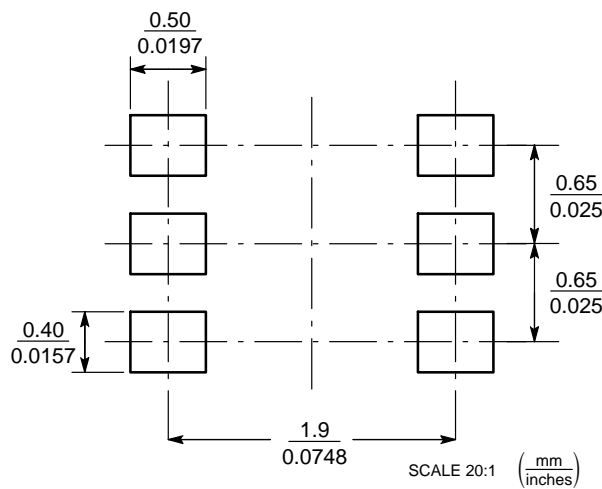
| DIM | MILLIMETERS |      |      | INCHES    |       |       |
|-----|-------------|------|------|-----------|-------|-------|
|     | MIN         | NOM  | MAX  | MIN       | NOM   | MAX   |
| A   | 0.80        | 0.95 | 1.10 | 0.031     | 0.037 | 0.043 |
| A1  | 0.00        | 0.05 | 0.10 | 0.000     | 0.002 | 0.004 |
| A3  | 0.20 REF    |      |      | 0.008 REF |       |       |
| b   | 0.10        | 0.21 | 0.30 | 0.004     | 0.008 | 0.012 |
| C   | 0.10        | 0.14 | 0.25 | 0.004     | 0.005 | 0.010 |
| D   | 1.80        | 2.00 | 2.20 | 0.070     | 0.078 | 0.086 |
| E   | 1.15        | 1.25 | 1.35 | 0.045     | 0.049 | 0.053 |
| e   | 0.65 BSC    |      |      | 0.026 BSC |       |       |
| L   | 0.10        | 0.20 | 0.30 | 0.004     | 0.008 | 0.012 |
| HE  | 2.00        | 2.10 | 2.20 | 0.078     | 0.082 | 0.086 |



单击下面可查看定价，库存，交付和生命周期等信息

[>>LRC\(乐山无线电\)](#)

[>>点击查看相关商品](#)