

---

## Sup/IRBuck™

### USER GUIDE FOR IR3847 EVALUATION BOARD

#### DESCRIPTION

The IR3847 is a synchronous buck converter, providing a compact, high performance and flexible solution in a small 5mmx6mm QFN package.

Key features offered by the IR3847 include internal Digital Soft Start, precision 0.6V reference voltage, Power Good, thermal protection, programmable switching frequency, Enable input, input under-voltage lockout for proper start-up, enhanced line/load regulation with feed forward, external frequency synchronization with smooth clocking, internal LDO, true differential remote sensing and pre-bias start-up.

A thermally compensated output over-current protection function is implemented by sensing the voltage developed across the on-resistance of the synchronous rectifier MOSFET for optimum cost and performance.

This user guide contains the schematic and bill of materials for the IR3847 evaluation board. The guide describes operation and use of the evaluation board itself. Detailed application information for IR3847 is available in the IR3847 data sheet.

---

#### BOARD FEATURES

- $V_{in} = +12V (+ 13.2V \text{ Max})$ , **No Vcc required.**
- $V_{out} = +1.2V @ 0-25A$
- $F_s = 600kHz$
- $L = 0.215\mu H$
- $C_{in} = 7 \times 22\mu F$  (ceramic 1206) +  $1 \times 330\mu F$  (electrolytic)
- $C_{out} = 10 \times 47\mu F$  (ceramic 0805)

**CONNECTIONS and OPERATING INSTRUCTIONS**

A well regulated +12V input supply should be connected to VIN+ and VIN-. A maximum of 25A load should be connected to VOUT+ and VOUT-. The inputs and output connections of the board are listed in Table I.

IR3847 needs only one input supply and internal LDO generates Vcc from Vin. If operation with external Vcc is required, then R33 should be removed and external Vcc can be applied between Vcc+ and Vcc- pins. Vin pin and Vcc pins should be shorted together for external Vcc operation by installing R35.

The board is configured for remote sensing. If local sense is desired, R8 should be uninstalled and R16 should be installed instead.

External Enable signal can be applied to the board via exposed Enable pad and *R18 should be removed for this purpose.*

**Table I. Connections**

Connection	Signal Name
VIN+	Vin (+12V)
VIN-	Ground of Vin
Vout+	Vout(+1.2V)
Vout-	Ground for Vout
Vcc+	Vcc Pin
Vcc-	Ground for Vcc input
Enable	Enable
PGood	Power Good Signal
AGnd	Analog ground

**LAYOUT**

The PCB is a 6-layer board. All of layers are 2 Oz. copper. The IR3847 and most of the passive components are mounted on the top side of the board.

Power supply decoupling capacitors and feedback components are located close to IR3847. The feedback resistors are connected to the output of the remote sense amplifier of the IR3847 and are located close to the IR3847. To improve efficiency, the circuit board is designed to minimize the length of the on-board power ground current path. Separate power ground and analog ground are used and may be connected together using a 0 ohm resistor at one of three possible locations. It is preferred to use one of R43 or R44.

**CONNECTIONS and OPERATING INSTRUCTIONS**

**LAYOUT**

The PCB is a 6-layer board. All of layers are 2 Oz. copper. The IR3847 and most of the passive components are mounted on the top side of the board.

Power supply decoupling capacitors and feedback components are located close to IR3847. The feedback resistors are connected to the output of the remote sense amplifier of the IR3847 and are located close to the IR3847. To improve efficiency, the circuit board is designed to minimize the length of the on-board power ground current path. Separate power ground and analog ground are used and may be connected together using a 0 ohm resistor at one of three possible locations. It is preferred to use one of R43 or R44.

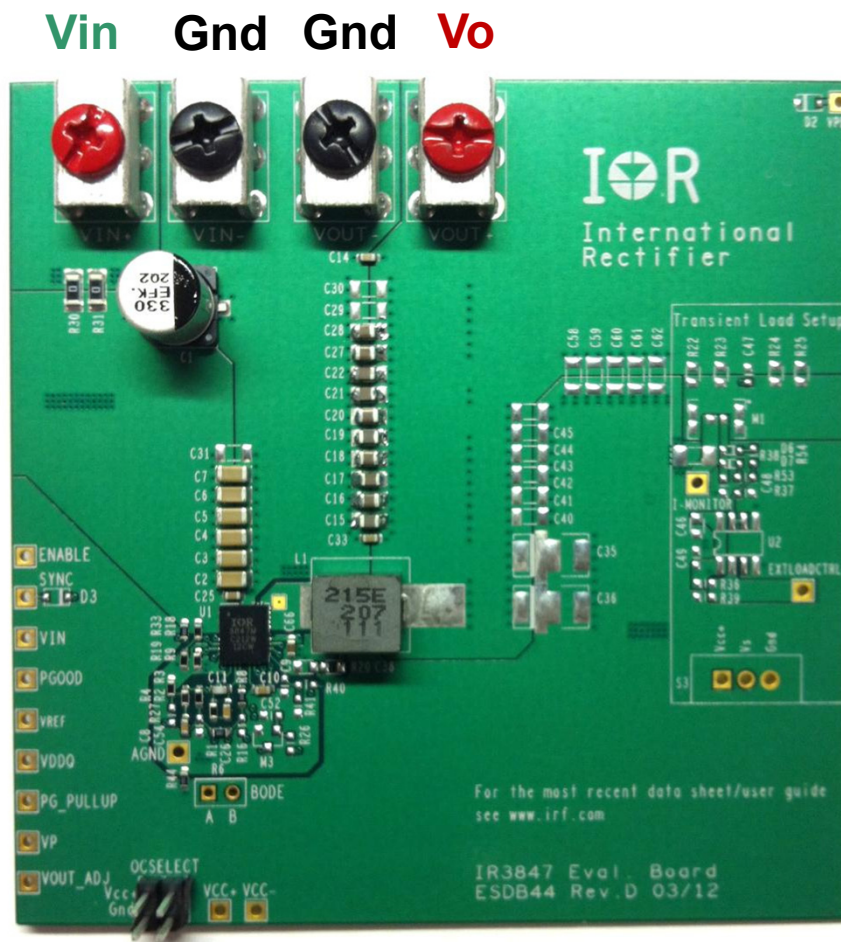

**Top View**

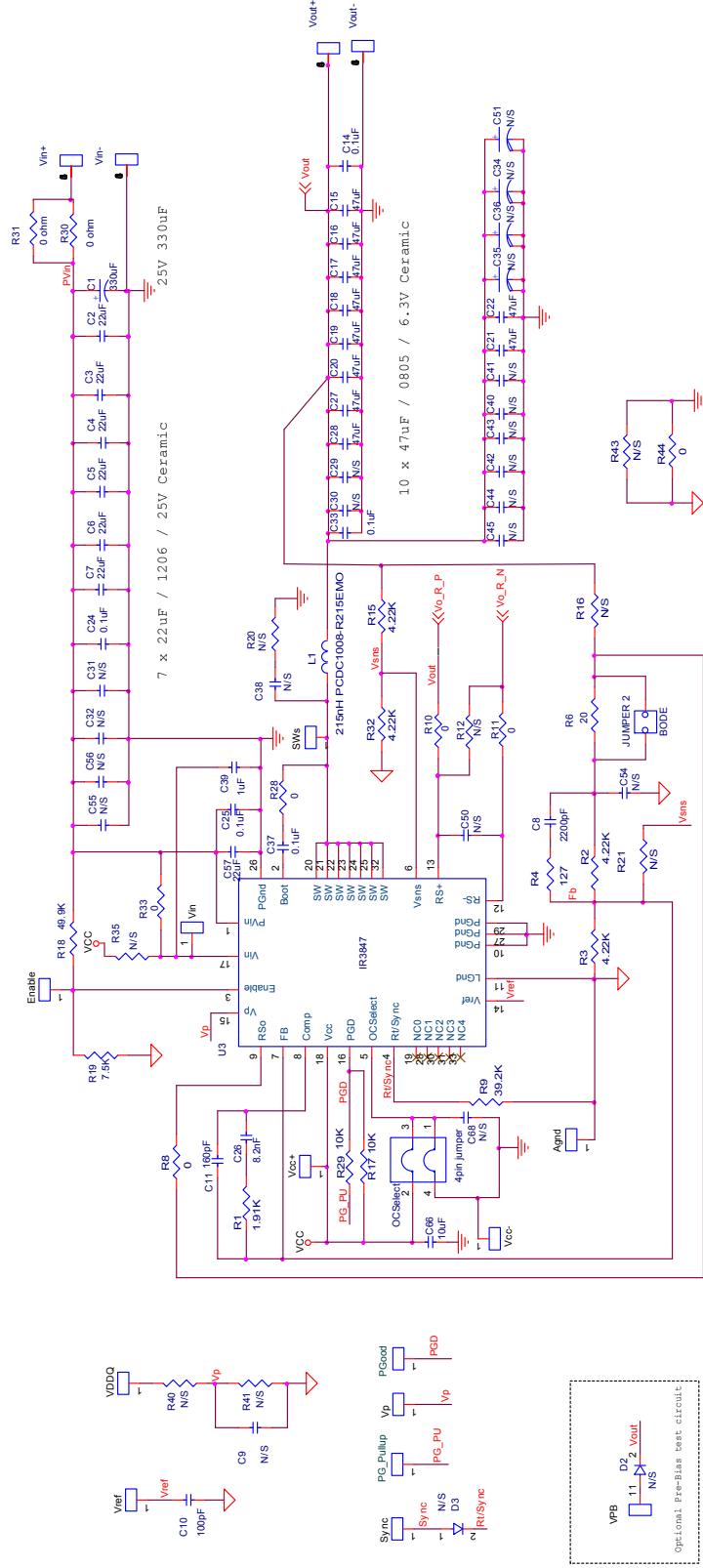

Single point of connection between Power Ground and Signal ( "analog" ) Ground

**Fig. 1: Schematic of the IR3847 evaluation board**

**Schematic for Transient Load set up**

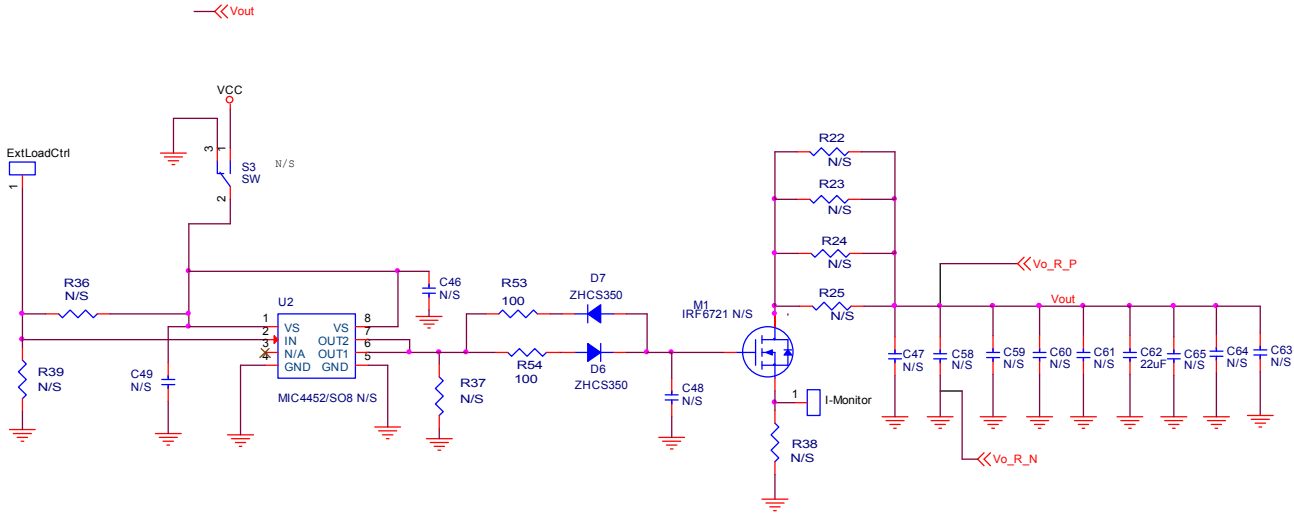

Optional transient load circuit

Bill of Materials

Item	Quantity	Part Reference	Value	Description	Manufacturer	Part Number
1	7	C2 C3 C4 C5 C6 C7 C57	22uF	1206, 25V, X5R, 10%	Murata	GRM31CR61E226KE15L
2	1	C1	330uF	SMD Electrolytic, Fsize, 25V, 20%	Panasonic	EEV-FK1E331P
3	6	C9 C14 C24 C25 C37 C33	0.1uF	0603, 25V, X7R, 10%	Murata	GRM188R71E104KA01D
4	1	C8	2200pF	2200pF,0603,50V,X7R	Murata	GRM188R71H222KA01D
5	1	C11	160pF	50V, 0603, NP0, 5%	Murata	GRM1885C1H161JA01D
6	10	C16 C17 C18 C19 C20 C27 C28 C29 C30 C36	47uF	0805, 6.3V, X5R, 20%	TDK	C2012X5R0J476M
7	1	C26	8.2nF	0603, 50V, X7R, 10%	Murata	GRM188R71H822KA01D
8	1	L1	0.215uH	0.215uH, DCR=0.29mohm	Cyntec	PCDC1008-R215EMO
9	1	R1	1.91K	0603,1/10W,1%	Panasonic	ERJ-3EKF1911V
10	1	R2	4.22K	0603,1/10W,1%	Panasonic	ERJ-3EKF4221V
11	1	R3	4.22K	0603,1/10W,1%	Panasonic	ERJ-3EKF4221V
12	1	R4	127	0603,1/10W,1%	Panasonic	ERJ-3EKF1270V
13	1	R6	20	0603,1/10 W,1%	Vishay/Dale	CRCW060320R0FKEA
14	1	R9	39.2K	0603,1/10 W,1%	Panasonic	ERJ-3EKF3922V
15	7	R8 R28 R10 R11 R44 R33 R34	0	0603,1/10 W,5%	Vishay/Dale	CRCW06030000Z0EA
16	1	C39	1uF	0603, X5R, 25V, 20%	TDK	C1608X5R1E105M
17	1	C66	10uF	0603, X5R, 10V, 20%	TDK	C1608X5R1A106M
18	2	R15 R32	4.22K	0603,1/10 W,1%	Panasonic	ERJ-3EKF4221V
19	2	R30 R31	0	1206,1/4 W, 5%	Yageo	RC1206JR-070RL
20	1	R18	49.9K	0603,1/10 W,1%	Panasonic	ERJ-3EKF4992V
21	1	R19	7.5K	0603,1/10 W,1%	Panasonic	ERJ-3EKF7501V
22	2	R17 R29	10K	0603,1/10 W,1%	Panasonic	ERJ-3EKF1002V
23	1	Jumper		PLUG 40 POS DBL ROW STR	Omron Electronics Inc.	XG8W-4041-ND
24	2	Vin+ Vout+	RED	SCREW TERMINAL	Keystone Electronics	8199-2
25	2	Vin- Vout-	BLACK	SCREW TERMINAL	Keystone Electronics	8199-3
26	1	U1	IR3847	IR3847 5mm X6mm	International Rectifier	IR3847MPBF

## TYPICAL OPERATING WAVEFORMS

$V_{in}=12.0V$ ,  $V_o=1.2V$ ,  $I_o=0A-25A$ ,  $F_{sw}=600kHz$ , Room Temperature, No air flow

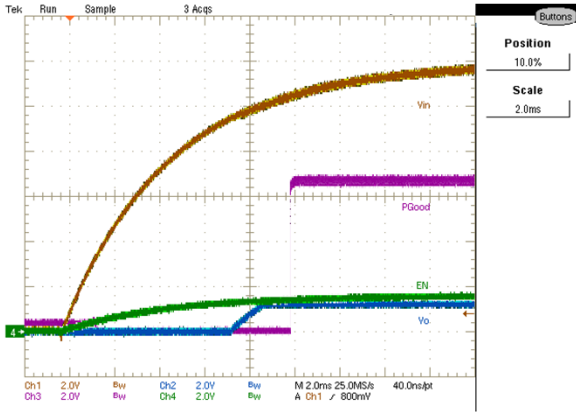

Fig. 2: Start up at 25A Load  
Ch<sub>1</sub>:V<sub>in</sub>, Ch<sub>2</sub>:V<sub>o</sub>, Ch<sub>3</sub>:PGood, Ch<sub>4</sub>:Enable

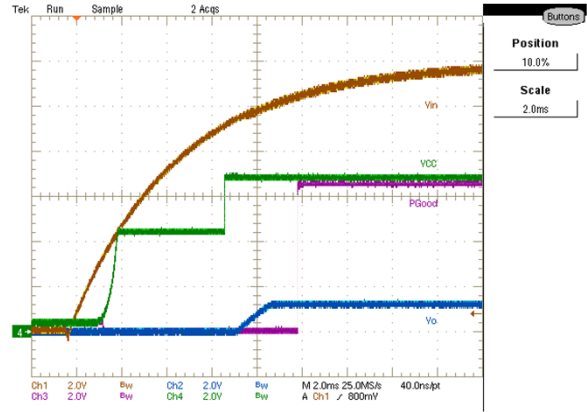

Fig. 3: Start up at 25A Load  
Ch<sub>1</sub>:V<sub>in</sub>, Ch<sub>2</sub>:V<sub>o</sub>, Ch<sub>3</sub>:PGood, Ch<sub>4</sub>:V<sub>cc</sub>

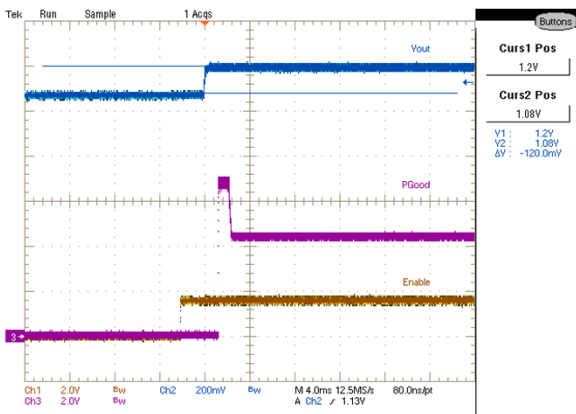

Fig. 4: Start up with 1.08V Pre Bias, 0A Load  
Ch<sub>1</sub>:Enable, Ch<sub>2</sub>:V<sub>out</sub>, Ch<sub>3</sub>:PGood

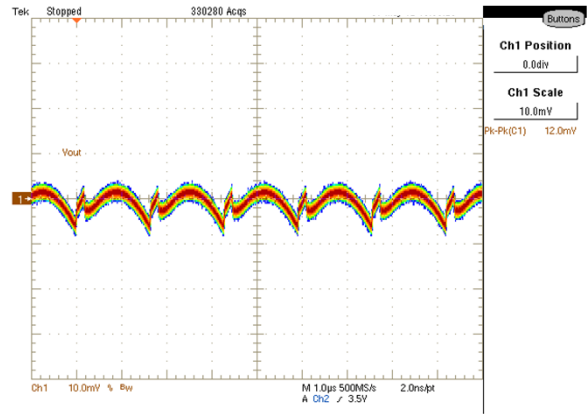

Fig. 5: Output Voltage Ripple, 25A load  
Ch<sub>1</sub>: V<sub>out</sub>

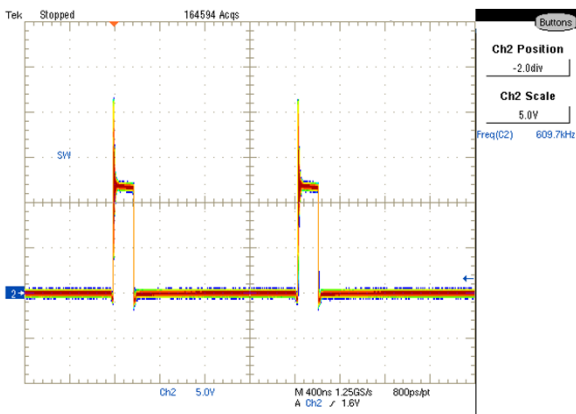

Fig. 6: Inductor node at 25A load  
Ch<sub>2</sub>:LX

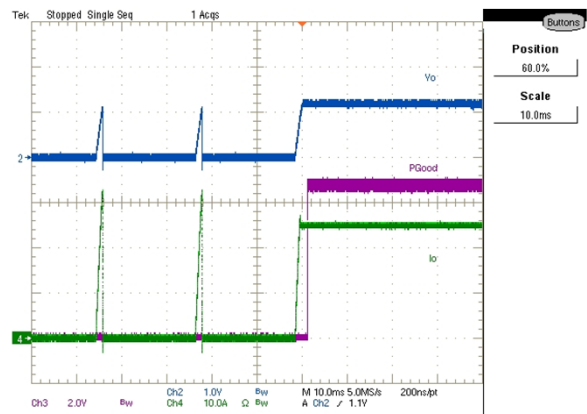

Fig. 7: Short (Hiccup) Recovery  
Ch<sub>2</sub>:V<sub>out</sub>, Ch<sub>3</sub>:PGood, Ch<sub>4</sub>:I<sub>out</sub>

**TYPICAL OPERATING WAVEFORMS**

Vin=12.0V, Vo=1.2V, Io=2.5A-12.5A, Fsw=600kHz, Room Temperature, No air flow

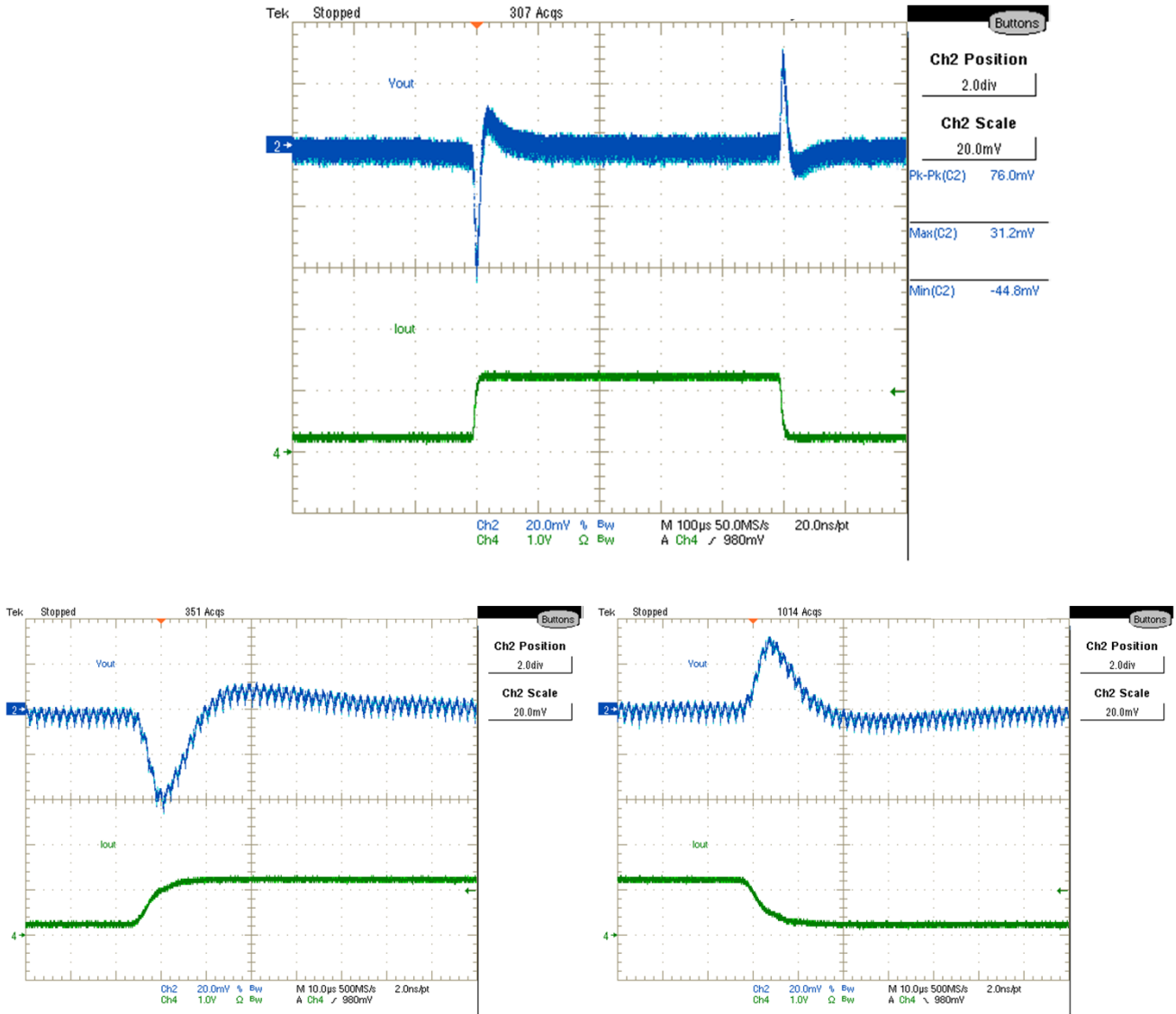

Fig. 8: Transient Response, 2.5A to 12.5A step (2.5A/us)  
 Ch<sub>2</sub>:Vout, Ch<sub>4</sub>:Iout(10A/V)



**TYPICAL OPERATING WAVEFORMS**

$V_{in}=12.0V$ ,  $V_o=1.2V$ ,  $I_o=15A-25A$ ,  $F_{sw}=600kHz$ , Room Temperature, No air flow

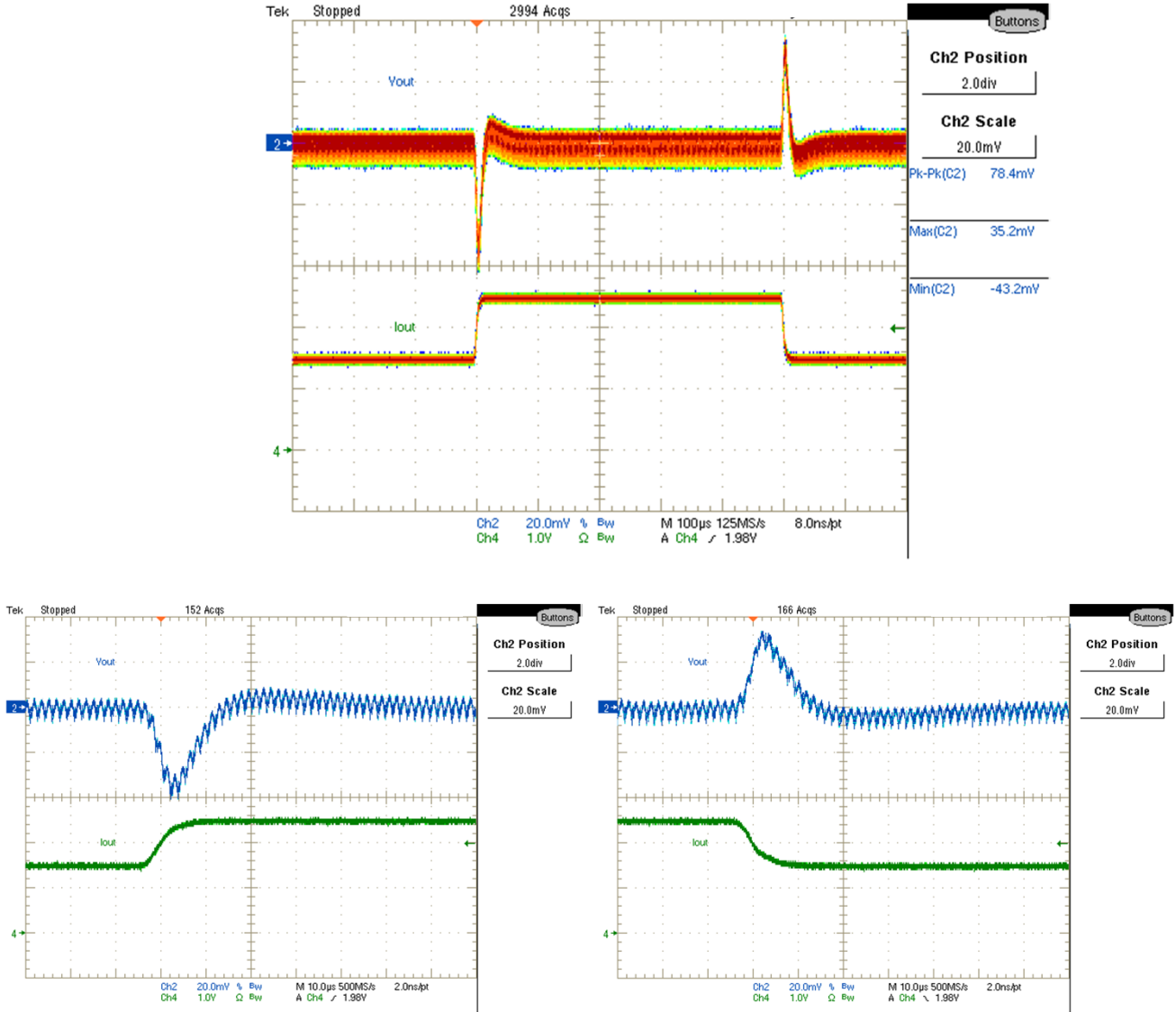

Fig. 9: Transient Response, 15A to 25A step (2.5A/us)  
 Ch<sub>2</sub>:Vout, Ch<sub>4</sub>:Iout(10A/V)

**TYPICAL OPERATING WAVEFORMS**

Vin=12.0V, Vo=1.2V, Io=0A-25A, Fsw=600kHz, Room Temperature, No air flow

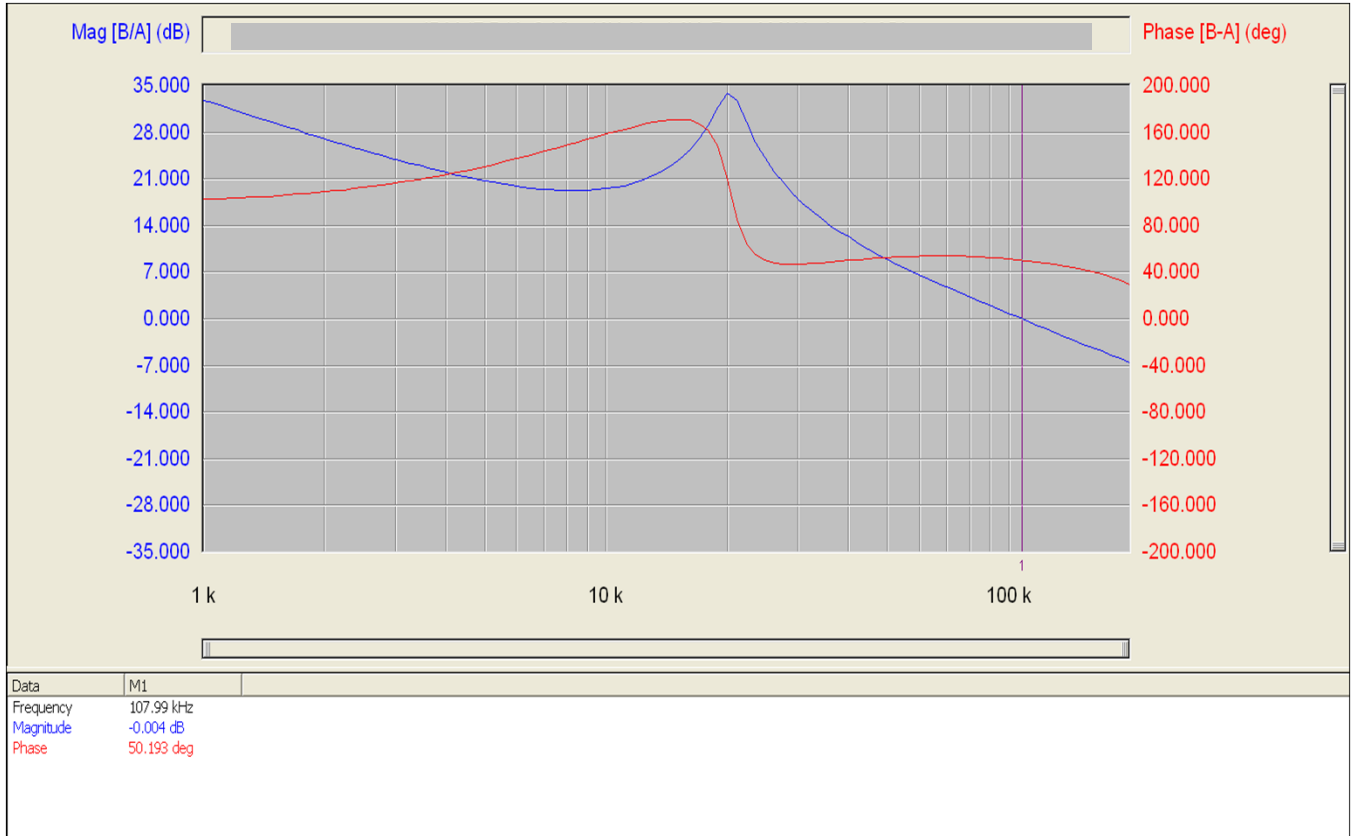

Fig. 10: Bode Plot at 25A load: Fo = 108.0kHz; Phase Margin = 50.2°

TYPICAL OPERATING WAVEFORMS

$V_{in}=12.0V$ ,  $V_o=1.2V$ ,  $I_o=0A-25A$ ,  $F_{sw}=600kHz$ , Room Temperature, No air flow

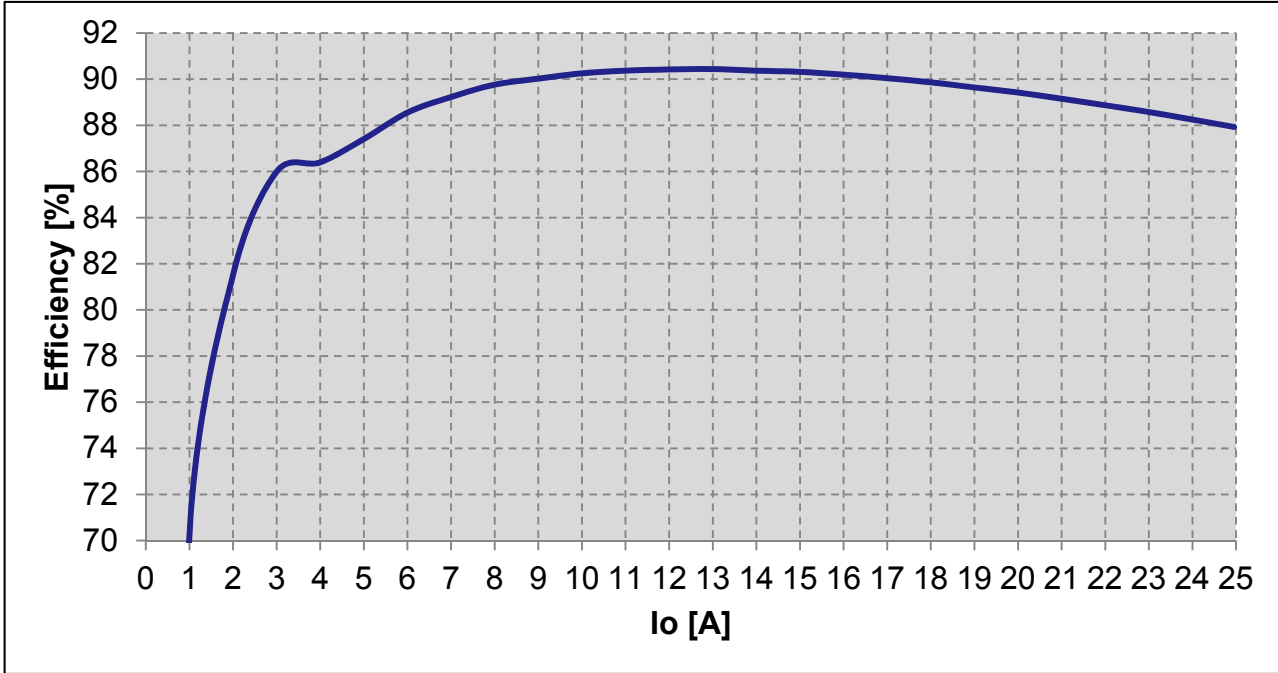

Fig.11: Efficiency versus load current

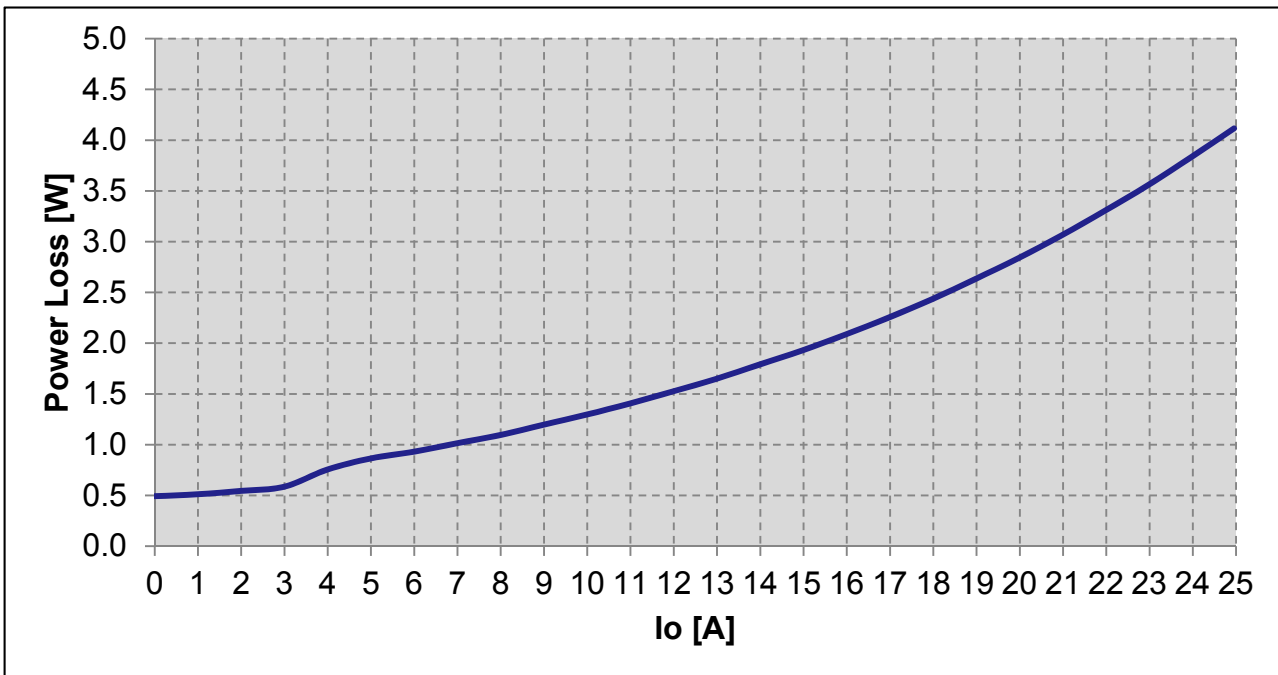

Fig.12: Power loss versus load current

THERMAL IMAGES

Vin=12.0V, Vo=1.2V, Io=0A-25A, Fsw=600kHz, Room Temperature, No air flow

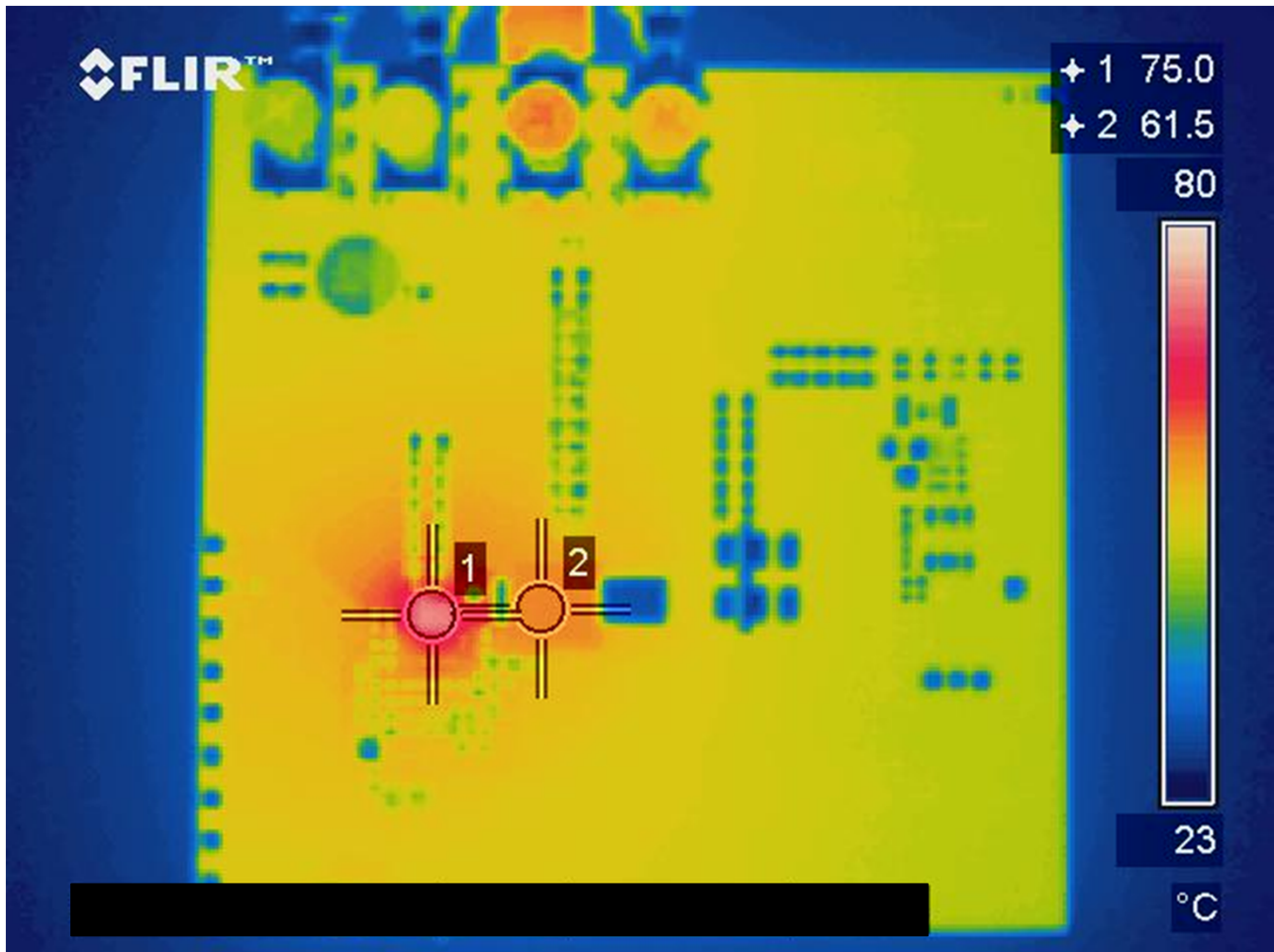

Fig. 13: Thermal Image of the board at 25A load  
Test point 1 is IR3847: 75°C  
Test point 2 is inductor: 61.5°C

International  
**IOR**Rectifier

**IR WORLD HEADQUARTERS:** 233 Kansas St., El Segundo, California 90245, USA Tel: (310) 252-7105  
TAC Fax: (310) 252-7903

Visit us at [www.irf.com](http://www.irf.com) for sales contact information  
*Data and specifications subject to change without notice. 10/11*

单击下面可查看定价，库存，交付和生命周期等信息

[>>Infineon Technologies\(英飞凌\)](#)