

SODZ ***A -SH Series

GLASS PASSIVATED JUNCTION Zener voltage regulator diodes

1.0 Watt Steady State

Feature

- * 1 W SOD-123-FL
- * Zener voltage regulator diodes
- * Plastic package has Underwriters Laboratory Flammability Classification 94V-0
- * We declare that the material of product compliance with RoHS requirements.
- * Guarding for over voltage protection
- * High temperature soldering guaranteed:
260°C/10 seconds at terminals
- * MSL: 1

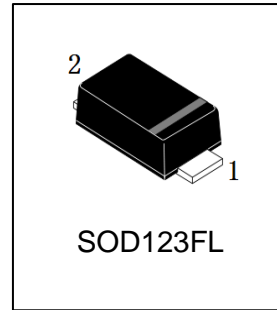

Mechanical Data

Case: JEDEC SOD-123-FL/MINI SMA molded plastic

Terminals: Plated terminals, solderable per MIL-STD-750, Method 2026

Polarity: Color band denoted cathode except Bipolar

Mounting Position: Any

Weight: Approximated 0.0155 gram

1. Electrical Characteristic

Ratings at 25°C ambient temperature unless otherwise specified.

Single phase, half wave, 60Hz, resistive or inductive load.

For capacitive load, derate current by 20%.

| RATING | SYMBOL | VALUE | UNITS |
|--|----------------|-------------|-------|
| Steady State Power Dissipation at $T_J=75^\circ\text{C}$ (Note1) | $P_{M(AV)}$ | 1.0 | Watts |
| Z-current | I_Z | P_V/V_Z | mA |
| Operating and Storage Temperature Range | T_J, T_{STG} | -50 to +150 | °C |

NOTES:

1. 8.0mm² (.013mm thick) land areas
2. 8.3ms single half sine-wave, duty cycle= 4 pulses per minutes maximum.

We declare that the material of product is Halogen free (green epoxy compound)

SODZ ***A -SH Series

2.Product Characteristic

Vz tolerance : ±5%; Tested with pulse tp=40ms;Ta=25 °C Vmax =1.2V @ IF = 200mA P=1 W

| Type | Device marking code | Zener | Current | A and B Suffix only | | | Leakage Current | | Maximum Regulator Current(2) | |
|-------------|---------------------|----------------|---------|---------------------|----------|----------|-----------------|-------|------------------------------|-----|
| | | Voltage | Izt | Zzt @ Izt | Zzk@ Izk | Zzk@ Izk | IR | VR | IZM @ Tamb =50 ° C | |
| | | $V_z @ I_{zt}$ | | | | | | | | |
| | | Volts | mA | Ohms | Ohms | m A | uA Max | Volts | mA | |
| SODZ5.1A-SH | Z5.1 | 5.1 | 49 | 7 | 550 | 1 | 100 | 1.0 | 178 | |
| SODZ5.6A-SH | Z5.6 | 5.6 | 45 | 5 | 600 | | | 2.0 | 164 | |
| SODZ6.2A-SH | Z6.2 | 6.2 | 41 | 2 | 700 | | | 3.0 | 146 | |
| SODZ6.8A-SH | Z6.8 | 6.8 | 37 | 4 | 1300 | | | 4 | 133 | |
| SODZ7.5A-SH | Z7.5 | 7.5 | 34 | 4.5 | 1300 | | | 0.5 | 5 | 121 |
| SODZ8.2A-SH | Z8.2 | 8.2 | 31 | 5.5 | 1300 | | | 0.5 | 6 | 110 |
| SODZ9.1A-SH | Z9.1 | 9.1 | 28 | 6 | 1300 | | | 0.5 | 7 | 100 |
| SODZ10A-SH | Z10 | 10 | 25 | 7 | 1300 | 0.25 | 5 | 7.6 | 91 | |
| SODZ11A-SH | Z11 | 11 | 23 | 8 | 1300 | | | 8.4 | 83 | |
| SODZ12A-SH | Z12 | 12 | 21 | 9 | 1300 | | | 9.1 | 76 | |
| SODZ13A-SH | Z13 | 13 | 19 | 10 | 1300 | | | 9.9 | 69 | |
| SODZ15A-SH | Z15 | 15 | 17 | 14 | 1300 | | | 11.4 | 61 | |
| SODZ16A-SH | Z16 | 16 | 15.5 | 16 | 1300 | | 5 | 12.2 | 57 | |
| SODZ18A-SH | Z18 | 18 | 14 | 20 | 1300 | | | 13.7 | 50 | |
| SODZ20A-SH | Z20 | 20 | 12.5 | 22 | 1300 | | | 15.2 | 45 | |
| SODZ22A-SH | Z22 | 22 | 11.5 | 23 | 1300 | | | 16.7 | 41 | |
| SODZ24A-SH | Z24 | 24 | 10.5 | 25 | 1300 | | | 18.2 | 38 | |
| SODZ27A-SH | Z27 | 27 | 9.5 | 35 | 1300 | | 20.6 | 34 | | |
| SODZ30A-SH | Z30 | 30 | 8.5 | 40 | 1500 | | 22.8 | 30 | | |
| SODZ33A-SH | Z33 | 33 | 7.5 | 45 | 1500 | | 5 | 25.1 | 27 | |
| SODZ36A-SH | Z36 | 36 | 7 | 50 | 1500 | | | 27.4 | 25 | |
| SODZ39A-SH | Z39 | 39 | 6.5 | 60 | 1500 | | | 29.7 | 23 | |
| SODZ43A-SH | Z43 | 43 | 6 | 70 | 2500 | | | 32.7 | 22 | |
| SODZ47A-SH | Z47 | 47 | 5.5 | 80 | 2500 | | | 35.8 | 19 | |
| SODZ51A-SH | Z51 | 51 | 5 | 95 | 2500 | | | 38.8 | 18 | |
| SODZ56A-SH | Z56 | 56 | 4.5 | 110 | 2500 | | | 42.6 | 16 | |
| SODZ62A-SH | Z62 | 62 | 4 | 125 | 2500 | | | 47.1 | 14 | |
| SODZ68A-SH | Z68 | 68 | 3.7 | 150 | 2500 | 51.7 | | 13 | | |
| SODZ75A-SH | Z75 | 75 | 3.3 | 175 | 2500 | 56 | | 12 | | |
| SODZ82A-SH | Z82 | 82 | 3 | 200 | 3000 | 62.2 | 11 | | | |
| SODZ91A-SH | Z91 | 91 | 2.8 | 250 | 3000 | 69.2 | 10 | | | |
| SODZ100A-SH | Z100 | 100 | 2.5 | 350 | 3000 | 76 | 9 | | | |
| SODZ110A-SH | Z110 | 110 | 2 | 550 | 5000 | 83 | 8 | | | |
| SODZ120A-SH | Z120 | 120 | 1.5 | 750 | 5500 | 90 | 7 | | | |
| SODZ130A-SH | Z130 | 130 | 1 | 900 | 6000 | 98 | 6 | | | |
| SODZ150A-SH | Z150 | 150 | 1 | 1200 | 6500 | 113 | 6 | | | |
| SODZ160A-SH | Z160 | 160 | 1 | 1350 | 7000 | 120 | 6 | | | |
| SODZ180A-SH | Z180 | 180 | 1 | 1650 | 8500 | 135 | 5 | | | |
| SODZ200A-SH | Z200 | 200 | 1 | 1950 | 10000 | 150 | 4 | | | |

SODZ ***A -SH Series

3.Characteristic Curves

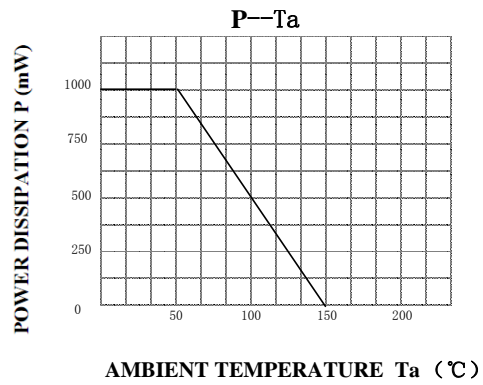
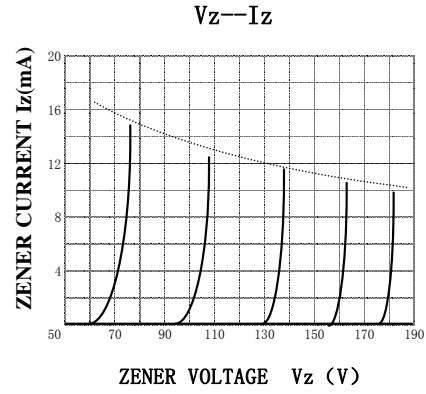
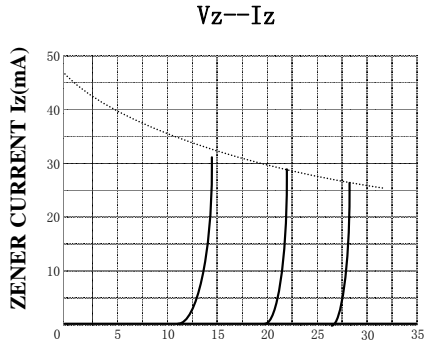

4. OUTLINE AND DIMENSIONS

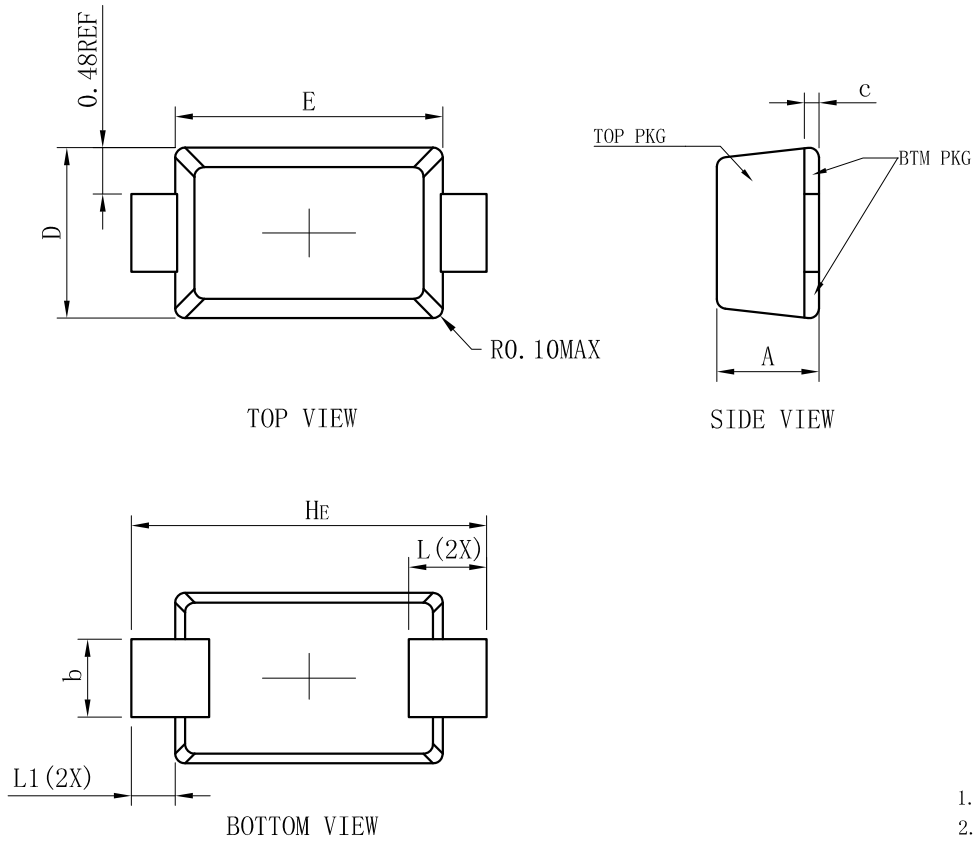

| SOD123FL | | | |
|----------------------|----------|------|------|
| DIM | MIN | NOR | MAX |
| A | 0.90 | 1.05 | 1.15 |
| b | 0.75 | 0.80 | 0.95 |
| L | 0.80REF. | | |
| E | 2.60 | 2.75 | 2.90 |
| D | 1.60 | 1.75 | 1.90 |
| HE | 3.50 | 3.65 | 3.80 |
| c | 0.12 | 0.17 | 0.22 |
| L1 | 0.45REF. | | |
| All Dimensions in mm | | | |

GENERAL NOTES

1. Top package surface finish $Ra0.4 \pm 0.2\mu m$
2. Bottom package surface finish $Ra0.7 \pm 0.2\mu m$
3. Side package surface finish $Ra0.4 \pm 0.2\mu m$

5. SOLDERING FOOTPRINT

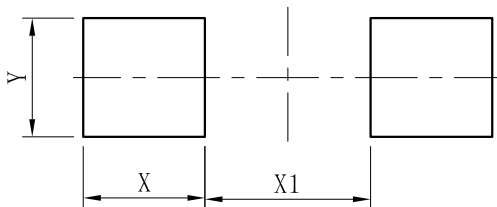

| DIM | (mm) |
|-----|------|
| X | 1.20 |
| Y | 1.10 |
| X1 | 2.00 |

SODZ ***A -SH Series

6. Suggested thermal profile for soldering process

1. Storage environment : Temperature=5~40°C Humidity=55±25%
2. Reflow soldering of surface-mount device

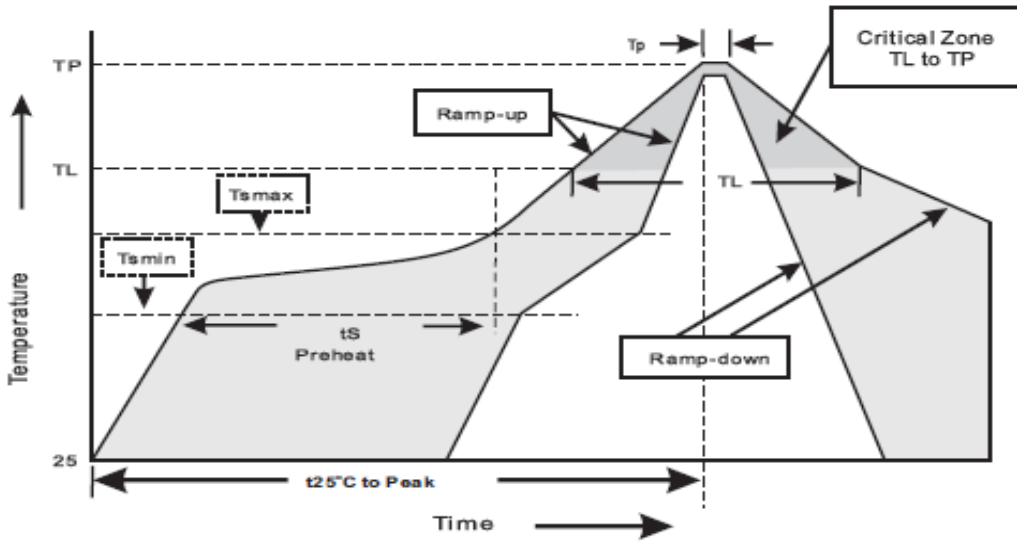

3. Reflow soldering

| Profile Feature | Soldering Condition |
|---|---------------------|
| Average ramp-up rate(T_L to T_P) | <3°C/sec |
| Preheat | |
| - Temperature Min(T_{smin}) | 150°C |
| - Temperature Max(T_{smax}) | 200°C |
| - Time(min to max)(t_s) | 60~120sec |
| T_{smax} to T_L | |
| - Ramp-up Rate | <3sec |
| Time maintained above: | |
| - Temperature (T_L) | 217°C |
| - Time(t_L) | 60-260sec |
| Peak Temperature(T_P) | 255 -0/+5°C |
| Time within 5°C of actual Peak Temperature(T_P) | 10~30sec |
| Ramp-down Rate | <6°C/sec |
| Time 25°C to Peak Temperature | <6minutes |

SODZ ***A -SH Series

7.High reliability test capabilities

| Item Test | Condition | Reference |
|-------------------------------|--|----------------------------|
| Solder Resistance | at 260±5°C for 10±2sec immerse body into solder 1/16" ± 1/32" | MIL-STD-750D METHOD-2031 |
| Solderability | at 245±5°C for 5 sec | MIL-STD-202F METHOD-208 |
| High Temperature Reverse Bias | V _R =80% rate at T _J =150°C for 168hrs | MIL-STD-750D METHOD-1038 |
| Forward Operation Life | Rated average rectifier current T _A =25°C for 500hrs | MIL-STD-750D METHOD-1027 |
| Intermittent Operation Life | T _A =25°C , I _F =I _o On state:power on for 5 min. Off state:power off for 5 min. on and off for 500 cycles | MIL-STD-750D METHOD-1036 |
| Pressure Cooker | 15P _{SIG} at T _A =121°C for 4hrs | JESD22-A102 |
| Temperature Cycling | -55°C to +125°C dwelled for 30 min. and transferred for 5min. Total 10 cycles | MIL-STD-750D METHOD-1051 |
| Thermal Shock | 0°C for 5min. Rise to 100°C for 5min. Total 10 cycles | MIL-STD-750D METHOD-1056 |
| Forward Surge | 8.3ms single half sine-wave superimposed on rated load,one surge | MIL-STD-750D METHOD-4066-2 |
| Humidity | at T _A =85°C , RH=85% for 1000hrs | MIL-STD-750D METHOD-1021 |
| High Temperature Storage Life | at 175°C for 1000hrs | MIL-STD-750D METHOD-1031 |



Proprietary Information

Title: Power Packages Product Packing Specification

功率产品包装规范

Document Number: APS-QA-QS-009

Revision C

Page 3 of 6



8.1.2 Label position and QA stamp position.(Empty area) 标签张贴位置及QA印章位置。(印章盖在标签空白区)

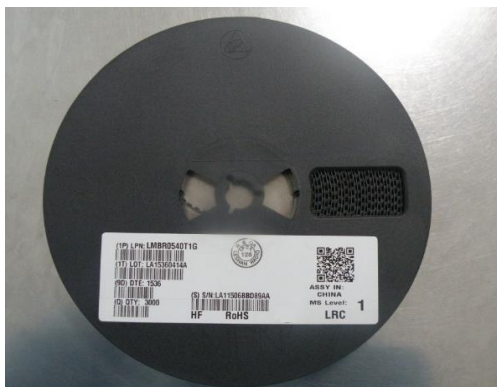

7英寸卷盘标签张贴及QA印章位置



13英寸卷盘标签张贴及QA印章位置

8.1.3 Ensure direction In the same reel. The same steel coil plate direction, With antistatic bubble to package reel. Refer to the below picture.

同一箱内的卷盘方向一致,用防静电泡沫对卷盘进行包裹。



7英寸卷盘防静电泡沫包裹



13英寸卷盘防静电泡沫包裹

Do not copy without written permission from Advanced Power Semiconductor



Proprietary Information

Title: Power Packages Product Packing Specification

功率产品包装规范

Document Number: APS-QA-QS-009

Revision C

Page 4 of 6

8.1.4 Put in the antistatic packing box after packaged reels. And QA stamp on the box label .

将包装好的卷盘放入防静电纸箱中，并在盒标签上盖章。



7 英寸卷盘内盒及标签



13 英寸卷盘内盒及标签

8.1.5 Product use printing inner box. 产品使用LRC印字内箱。



7英寸卷盘内箱印字（侧面）



13英寸卷盘内箱印字（正面）

8.1.6 Inner box packing quantity requirement. 内盒包装数量要求。

| Product Description | QTY |
|---------------------|-----------|
| SOD123-FL | 1-10Reels |
| SOD323-HE | 1-10Reels |
| SMA-FL | 1-7Reels |
| SMB-FL | 1-4Reels |

8.1.7 With transparent tape sealing. 透明胶带封箱。

Do not copy without written permission from Advanced Power Semiconductor



Proprietary Information

Title: Power Packages Product Packing Specification 功率产品包装规范

Document Number: APS-QA-QS-009

Revision C

Page 5 of 6



7英寸内箱封盒



13英寸内箱封盒

8.1.8 Outer box size and packing quantity requirement, 外箱尺寸及包装数量要求。

| Product Description | 卷盘尺寸 | Height (H) | Width (W) | Length (L) | Max. Qty |
|---------------------|-------|------------|-----------|------------|----------|
| Power Device | 7 英寸 | 410mm | 400mm | 445mm | 12 |
| Power Device | 13 英寸 | 410mm | 400mm | 445mm | 5 |



7 英寸卷盘产品装箱



13 英寸卷盘产品装箱

统一方向

Do not copy without written permission from Advanced Power Semiconductor



Proprietary Information

Title: Power Packages Marking & Taping Specification

功率封装字模和编带规范

Document Number: APS-QA-QS-010

Revision C

Page 6 of 9

8.2 Standard Products Taping Specification

标准产品编带规范

8.2.1 Tape length of no component

空带长度说明

Taping leader length 引导部分: $440\text{mm} \pm 40\text{mm}$, Tape trailer 尾部: $200\text{mm} \pm 40\text{mm}$

Figure 4

Tape Ends For Finished Goods Reel

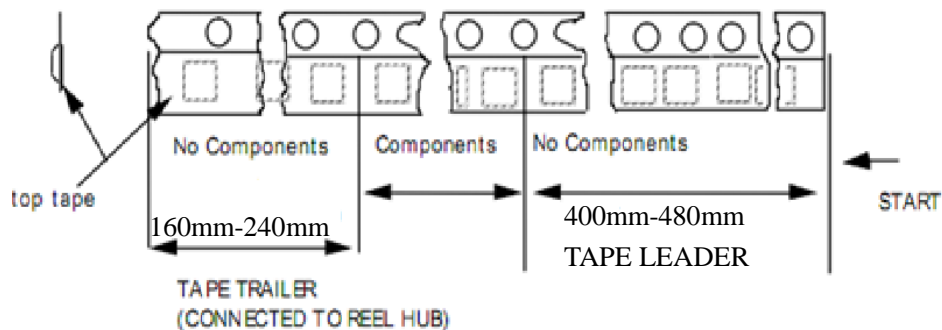

8.2.2 Component packaging orientation: The cathode lead is close to the carrier tape's index hole.

产品放置方向: 印阴极带引脚邻近载带索引孔



Do not copy without written permission from Advanced Power Semiconductor



Proprietary Information

Title: Power Packages Marking & Taping Specification

功率封装字模和编带规范

Document Number: APS-QA-QS-010

Revision C

Page 7 of 9

8.2.3 Tape enwind orientation

编带缠绕方向要求

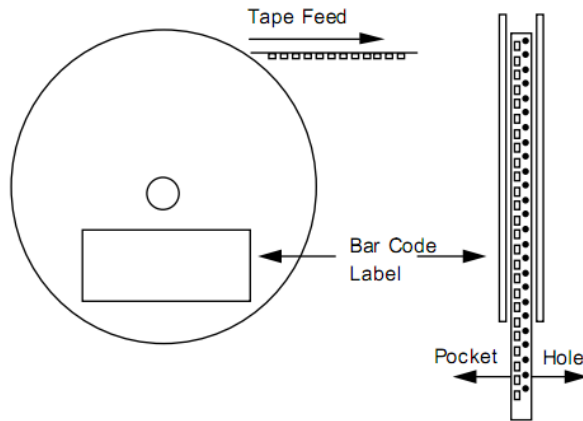

Do not copy without written permission from Advanced Power Semiconductor

单击下面可查看定价，库存，交付和生命周期等信息

[>>LRC\(乐山无线电\)](#)