

To : Guang Dong OPPO Mobile Telecommunications Corp

Specification number:EQM08-1KC-E201K06

Date of issue: 8 January, 2020

## Multilayer ceramic Chip capacitor specification

Product Part No

KNH05X5R156M04AH

(Recipient stamp column)

Please send back with recipient stamp or signature here.

This specification would be invalidated unless sent back within a year after issue date of this specification.

**RoHS Compliant**

Kyocera Corporation  
Capacitor Division







**1.Scope**

This specification sheet shall be applied to multilayer ceramic chip capacitors;KNH series.

**2.Nomenclature**

KNH	□□	□□	□□□	□	□□	A	□
Series	(1)	(2)	(3)	(4)	(5)	(6)	(7)

- (1) : Size
- (2) : Temperature Characteristics
- (3) : Capacitance
- (4) : Tolerance
- (5) : Rated Voltage
- (6) : External Electrode
- (7) : Packaging

**(1)External Dimensions(Size)**

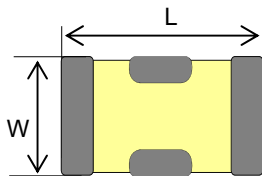

External Dimension (unit:mm)

Type	L	W	T	P	G
05	1.00±0.15	0.50±0.15	0.50±0.15	0.15±0.10	0.30±0.10

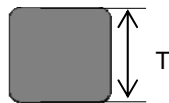
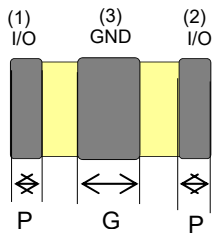

**(2)Temperature Characteristics**

Characteristics	Applied voltage	Change in capacitance	Operating temperature range	Reference
X5R	No applied voltage	Within +/-15%	-55°C~+85°C	25°C



**(3)Capacitance Value**

Capacitance is indicated by three numbers and a letter (see example as follows).  
The first and second digits indicate the first two significant figures, and the final digit is a base 10 logarithmic multiplier in picofarads.

(Ex.)

Code	Capacitance
156	15,000,000pF

**(4)Tolerance**

Code	M
Tolerance	±20%

**(5)Rated Voltage**

Code	04
Voltage	4Vdc

**(6)Termination (External Electrode)**

A: Nickel Barrier / Tin

**(7)Packaging Configuration**

Code	Packaging Configuration	Applying Size
H	Taping(2mm Pitch. $\Phi$ 180 Reel)	Refer to Taping specification

**3. Specifications**

Part No.	Rated current	Direct-current resistance	Operating temperature
KNH05X5R156M04AH	2A	0.03 $\Omega$ MAX	-55°C~+85°C



## 4.Specifications and Test Methods

(Table 1-1)

Item		Specification	Measuring Conditions
		X5R	
Capacitance		Within specified tolerance value	High Temperature Treatment (Table 2) C>10 $\mu$ F Measuring frequency 120Hz $\pm$ 10% Measuring voltage Refer to (Table 3)
(*1)Insulation Resistance		Refer to (Table 3)	Measure after charging with the rated voltage within 1 minutes at room conditions.
(*1)Dielectric Strength		No problem observed	Applying 2.5 times of the rated voltage for 1 to 5 seconds.
Current resistance		No problem observed.	Measurement Current : Rated Current Impression time : 1 to 5 seconds
Appearance		No serious defect	Under Microscope
Resistance to Solder Leaching	Appearance	No serious defect	Perform High Temperature Treatment (Table 2) , then measure the initial capacitance and tan $\delta$ .  After dipped molten solder, at 260 $\pm$ 5 $^{\circ}$ C for 10 $\pm$ 0.5 seconds and kept at room conditions for 24 $\pm$ 2 hours, measure and check the specifications.  *Pre-heat before immersion 1st: 80 $^{\circ}$ C to 100 $^{\circ}$ C for 120sec. 2st:150 $^{\circ}$ C to 200 $^{\circ}$ C for 120sec.
	Capacitance Variation	Within $\pm$ 30%	
	(*1)Insulation Resistance	Within specified tolerance value	
	(*1)Dielectric Strength	Resist without problem.	
Solderability		Coverage $\geq$ 90% Each termination end	Soaking Condition <Sn-3Ag-0.5Cu> 245 $\pm$ 5 $^{\circ}$ C 3 $\pm$ 0.5sec. <Sn63 Solder> 235 $\pm$ 5 $^{\circ}$ C 2 $\pm$ 0.5sec.
Temperature Cycling	Appearance	No serious defect	Perform High Temperature Treatment (Table 2) , then measure the initial capacitance and tan $\delta$ .  <Cycle> Room temperature (3 minutes) - Lowest operating temperature (30 minutes) - Room temperature (3 minutes) - Highest operating temperature (30 minutes).  After 5 cycles of the above, keep at 150+0/-10 $^{\circ}$ C for 1 hour and then let sit for 24 $\pm$ 2 hours at room temperature, then measure. (Refer to Fig.2)
	Capacitance Variation	Refer to (Table 4)	
	(*1)Insulation Resistance	Refer to (Table 4)	
	(*1)Dielectric Strength	Resist without problem	

(Table 1-2)

Item		Specification		Measuring Conditions
		X5R		
Load Humidity Resistance	Appearance	No serious defect		Perform High Temperature Treatment (Table 2) , then measure the initial capacitance and tanδ.
	Capacitance Variation	Refer to (Table 4)		Apply rated voltage for 500+12/-0 hours in pre-condition at 40±2°C, humidity 90% to 95%RH.
	(*1)Insulation Resistance	Refer to (Table 4)		After test , keep at 150+0/-10°C for 1 hour and then let sit for 24±2 hours at room temperature, then measure.
High Temperature Life Test	Appearance	No serious defect		Perform High Temperature Treatment (Table 2) , then measure the initial capacitance and tanδ.
	Capacitance Variation	Refer to (Table 4)		Apply voltage (Magnification of Applied voltage × Rated voltage) for 1000+12/-0 hours in pre-condition at the highest temperature. * Magnification of Applied voltage: refer to (Table 4)
	(*1)Insulation Resistance	Refer to (Table 4)		After test , keep at 150+0/-10°C for 1 hour and then let sit for 24±2 hours at room temperature, then measure.
Bending Strength		No mechanical damage		Refer to Fig.3 Testing Board Thickness:0.8mm The glass epoxy board is bent up 1mm in 10 sec.

(\*1) Insulation Resistance/Dielectric Strength;Charging or discharging current for these tests Is limited under 50mA.

(Table 2)

Initial Treatment	High Temperature Treatment	Keep chip capacitor at 150°C +0/-10°C for 1 hour,Then leave chip capacitor at room temperature and normal humidity for 24±2 hours.

[Table3 Parts List]

Product Part No	Dimension [mm]			IR (initial) min	Capacitance Measuring voltage
	L	W	T		
KMH05X5R156M04AH	1.00±0.15	0.50±0.15	0.50±0.15	50 MΩ•μF	0.5±0.1Vrms

[Table4 test specifications]

Product Part No	Temperature Cycling		Load Humidity Resistance		High Temperature Life Test		
	Capacitance Variation	IR (Minimum value)	Capacitance Variation	IR (Minimum value)	Voltage Bias [%]	Capacitance Variation	IR (Minimum value)
KMH05X5R156M04AH	±30.0%	50 MΩ•μF	±30.0%	10 MΩ•μF	100%	±30.0%	10 MΩ•μF



■ Bending Strength

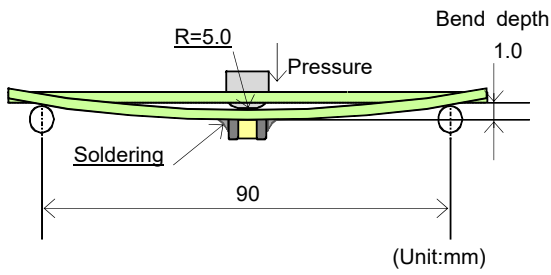
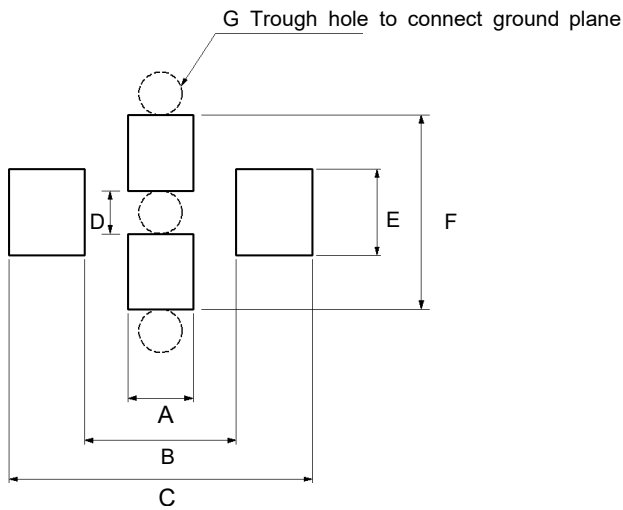

Fig.3 Testing status

■ Land Pattern

(Temperature cycle/ Humidity test/ Bending Strength)



Unit : mm

Symbol	Dimensions
A	0.30
B	0.70
C	1.40
D	0.20
E	0.40
F	0.90
G	0.20

■ Equivalent circuit and Internal structure

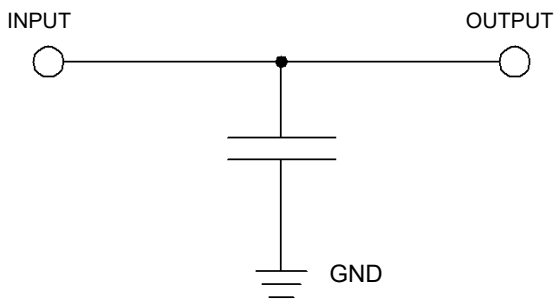

Fig. Equivalent circuit

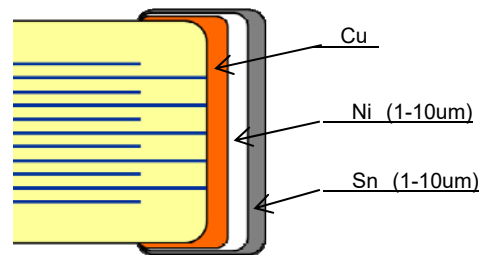

Fig. Internal structure

■ Production facility

Kagoshima Kokubu plant





■ For lead-free soldering Recommended temperature profile

• Reflow profile

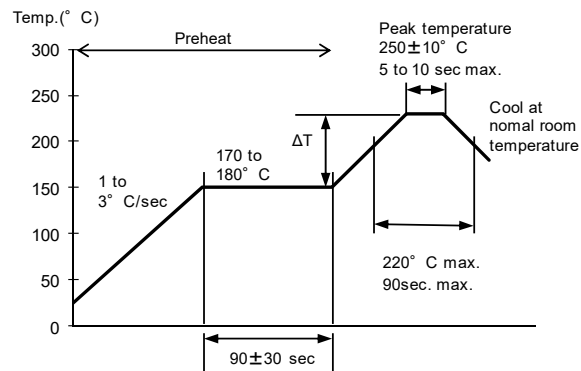

- (1) Minimize soldering time
- (2) Ensure that the temperature difference does not exceed  $150^\circ \text{C}$ .
- (3) MLCC can withstand the above reflow conditions up to 3 times.
- (4) Cool naturally after soldering.

• Flow profile

Flow is not applicable for chips with size KNH05.

**Taping Specification**

**1.Application**

This specification applies to paper carrier tape of Kyocera multi-layer ceramic chip capacitor.

**2.Packing unit**

type	thickness (unit:mm)	material of carrier tape		width of carrier tape		Φ180 reel quantity per reel
		paper	Plastic	8mm	12mm	
05	0.50±0.15	○	-	○	-	10000

**3.Shape and dimintions**

**(1)Reel**

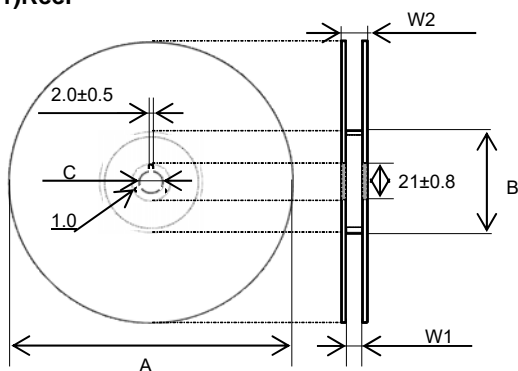

[Dimension]	Unit:mm		
	A	B	C
Φ180 reel (Code:H)	Φ180+0/-2.0	Φ60min	Φ13.0±0.5
	W1	W2	
Φ180 reel (Code:H)	10.0±1.5	16.5max	

**(2)Carrier Tape**

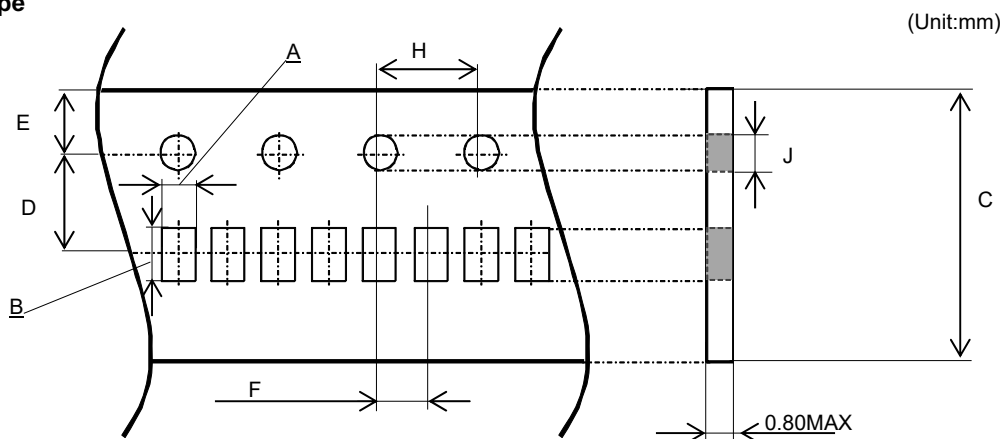

		(unit:mm)							
Code		A	B	C	D	E	F	H	J
Type	Tolerance	±0.1	±0.1	±0.3	±0.05	±0.1	±0.05	±0.1	+0.1/-0
	KNH05	0.75	1.15	8.0	3.5	1.75	2.0	4.0	Φ1.5



#### 4.Packing method

##### (1)Details of leader and trailer

- ①The tape will have a empty pocket at the leader and trailer of carrier tape.
- ②The tape end will not be stuck by glue in order to make it easier to peel off from reel.
- ③The feeding round hole will be on the right side against t leading direction.

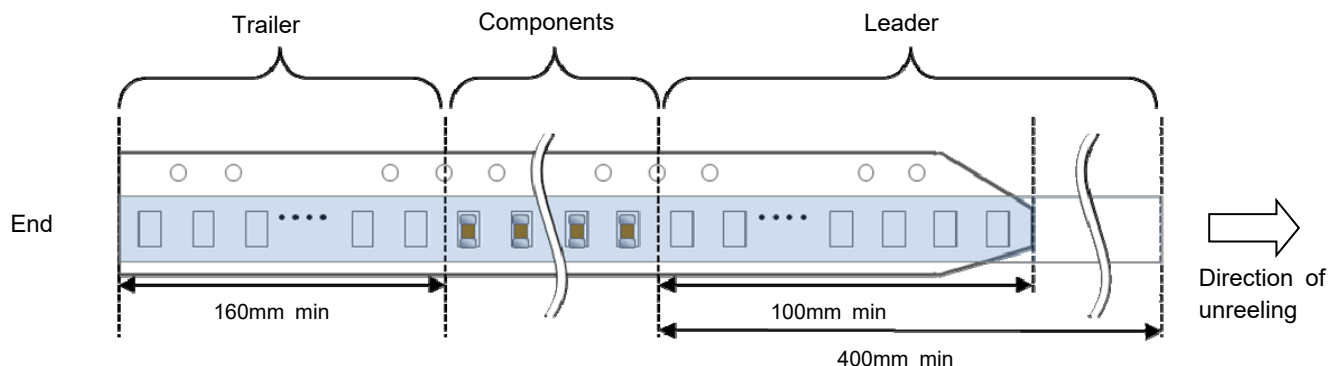

##### (2)Heat pressure tape

- ①Peeling strength to be 0.1~0.7N when peeling off the top tape by following method.
- ②When peeling top tape off, the glue will be stuck to the top tape side.
- ③Chip capacitor will not stuck on heat pressure tape and will be free in the cavity.

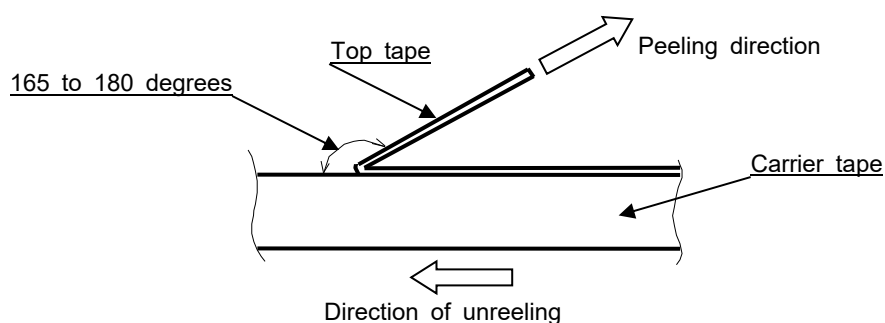

The peel-off angle:165~180 degree against the surface of carrier tape.  
The peel-off speed:300mm/min.

##### (3)Carrier tape

- ①Chip will not fall off from carrier tape or carrier tape will not be damaged by bending than within aradius of 25mm.
- ②The chip are inserted continuously without any empty pocket.
- ③Chip will not be mis-mounted because of too big clearance between components and cavity. Also the waste of carrier tape will not fill a nozzle hole of mouting machine.

#### 5.Indication and packing

- ①There will be following indication on one side of the reel: "PART NUMBER","LOT NUMBER", "QUANTITY","DATE OF MANUFACTURE","CUSTOMER'S NAME"
- ②There will be following indication on the reel box: "PART NUMBER","LOT NUMBER", "QUANTITY OF REEL","DATE OF MANUFACTURE","CUSTOMER'S NAME"
- ③We adequately pack the box to prevent chip capacitor from any mechanical damage during transportation.

## Precautions

### ■ Handling

- 1) Cracks may occur unless otherwise avoiding excessive stress to the capacitors by the load of an adsorption nozzle, and bending of a substrate at the time of mounting.
- 2) Please arrange the capacitor position where they don't have too much stress of board bending after mounting.
- 3) Please design that the form and size of the land pattern has suitable solder amount.  
Otherwise cracks may occur. The recommended fillet height shall be 1/2 to 1/3 of the thickness of capacitors.

### ■ Circuit Design

- 1) When AC voltage is superimposed on DC voltage, the zero-to-peak voltage shall not exceed the rated voltage. When the capacitor is to be employed in a circuit in which there is continuous application of a high frequency Voltage or a steep pulse voltage, even though it is within the rated voltage, please inquire to the manufacturer.
- 2) Please use the capacitor below the maximum temperature.  
When using the capacitor in a self-heating AC circuit, please make sure the surface of the capacitor remains under the maximum temperature for usage. Also, please make certain temperature rises remain below 20 °C.

### ■ Resin coating

Please use the resin of low curing shrinkage type. (Otherwise cracks may occur).

### ■ Storage

- 1) When the components is stored in minimal packaging (a heat-sealed or chuck-type plastic bag), the bag should be kept closed. Once the bag has been opened, reseal it or store it in a desiccator.
- 2) Keep storage place temperature +5 to +40 °C, humidity 20 to 70% RH.
- 3) The storage atmosphere must be free of gas containing sulfur and chlorine. Also, avoid exposing the product to saline moisture. If the product is exposed to such atmospheres, the terminals will oxidize and solderability will be effected.
- 4) Precautions 1) to 3) apply to chip capacitors packaged in carrier tapes and bulk cases.
- 5) The solderability is assured for 6 months from our shipping date if the above storage precautions are followed.

### ■ Application Restriction

Please consult with us before using a capacitor in the equipment which requires a high degree reliability (medical equipment, aerospace applications, nuclear equipment.) Malfunctions in medical, space, nuclear power or other vital equipment may result in death or great social losses. Capacitors designed specially with high reliability are used for the equipment above.

### ■ Export regulation

When the applying products relate the strategic materials which are provided in Foreign Exchange and Foreign Trade Act and Foreign Trade Management Law, the export license based on these laws are required.

### ■ Disposal

Please dispose the capacitors according to the relating laws about the waste treatment and cleaning. Safety application guideline and detailed information of electrical properties are also provided in Kyocera home page:

URL: <http://www.kyocera.co.jp/electronic>

### Notice:

This specification shall guarantee only monolithic capacitors. Please make sure the performance of capacitors after mounted on the assembled product.

Any failures occurred being used out of this specification shall not be guaranteed.

This specification shall be applied to the products purchased through the regular sales routes, such as the sale offices, the subsidiaries and the distributors, etc.).



单击下面可查看定价，库存，交付和生命周期等信息

[>>Kyocera\(京瓷\)](#)