

LED Driver

BCR 420U E6327 / BCR 421U E6327

Datasheet

Revision 2.1, 2015-01-28

Power Management & Multimarket

Edition 2015-01-28

**Published by
Infineon Technologies AG
81726 Munich, Germany**

**© 2015 Infineon Technologies AG
All Rights Reserved.**

Legal Disclaimer

The information given in this document shall in no event be regarded as a guarantee of conditions or characteristics. With respect to any examples or hints given herein, any typical values stated herein and/or any information regarding the application of the device, Infineon Technologies hereby disclaims any and all warranties and liabilities of any kind, including without limitation, warranties of non-infringement of intellectual property rights of any third party.

Information

For further information on technology, delivery terms and conditions and prices, please contact the nearest Infineon Technologies Office (www.infineon.com).

Warnings

Due to technical requirements, components may contain dangerous substances. For information on the types in question, please contact the nearest Infineon Technologies Office.

Infineon Technologies components may be used in life-support devices or systems only with the express written approval of Infineon Technologies, if a failure of such components can reasonably be expected to cause the failure of that life-support device or system or to affect the safety or effectiveness of that device or system. Life support devices or systems are intended to be implanted in the human body or to support and/or maintain and sustain and/or protect human life. If they fail, it is reasonable to assume that the health of the user or other persons may be endangered.

Revision History

Page or Item	Subjects (major changes since previous revision)
Revision 2.1, 2015-01-28	
All	Using full sales names BCR 420U E6327 / BCR 421U E6327 instead of short form BCR420U / BCR421U
Page 7	Halogen free logo removed

Trademarks of Infineon Technologies AG

AURIX™, C166™, CanPAK™, CIPOS™, CIPURSE™, EconoPACK™, CoolMOS™, CoolSET™, CORECONTROL™, CROSSAVE™, DAVE™, DI-POL™, EasyPIM™, EconoBRIDGE™, EconoDUAL™, EconoPIM™, EconoPACK™, EiceDRIVER™, eupec™, FCOS™, HITFET™, HybridPACK™, I²RF™, ISOFACE™, IsoPACK™, MIPAQ™, ModSTACK™, my-d™, NovalithIC™, OptiMOS™, ORIGA™, POWERCODE™, PRIMARION™, PrimePACK™, PrimeSTACK™, PRO-SIL™, PROFET™, RASIC™, ReverSave™, SatRIC™, SIEGET™, SINDRION™, SIPMOS™, SmartLEWIS™, SOLID FLASH™, TEMPFET™, thinQ!™, TRENCHSTOP™, TriCore™.

Other Trademarks

Advance Design System™ (ADS) of Agilent Technologies, AMBA™, ARM™, MULTI-ICE™, KEIL™, PRIMECELL™, REALVIEW™, THUMB™, μVision™ of ARM Limited, UK. AUTOSAR™ is licensed by AUTOSAR development partnership. Bluetooth™ of Bluetooth SIG Inc. CAT-ig™ of DECT Forum. COLOSSUS™, FirstGPS™ of Trimble Navigation Ltd. EMV™ of EMVCo, LLC (Visa Holdings Inc.). EPCOS™ of Epcos AG. FLEXGO™ of Microsoft Corporation. FlexRay™ is licensed by FlexRay Consortium. HYPERTERMINAL™ of Hilgraeve Incorporated. IEC™ of Commission Electrotechnique Internationale. IrDA™ of Infrared Data Association Corporation. ISO™ of INTERNATIONAL ORGANIZATION FOR STANDARDIZATION. MATLAB™ of MathWorks, Inc. MAXIM™ of Maxim Integrated Products, Inc. MICROTEC™, NUCLEUS™ of Mentor Graphics Corporation. MIPI™ of MIPI Alliance, Inc. MIPS™ of MIPS Technologies, Inc., USA. muRata™ of MURATA MANUFACTURING CO., MICROWAVE OFFICE™ (MWO) of Applied Wave Research Inc., OmniVision™ of OmniVision Technologies, Inc. Openwave™ Openwave Systems Inc. RED HAT™ Red Hat, Inc. RFMD™ RF Micro Devices, Inc. SIRIUS™ of Sirius Satellite Radio Inc. SOLARIS™ of Sun Microsystems, Inc. SPANSION™ of Spansion LLC Ltd. Symbian™ of Symbian Software Limited. TAIYO YUDEN™ of Taiyo Yuden Co. TEAKLITE™ of CEVA, Inc. TEKTRONIX™ of Tektronix Inc. TOKO™ of TOKO KABUSHIKI KAISHA TA. UNIX™ of X/Open Company Limited. VERILOG™, PALLADIUM™ of Cadence Design Systems, Inc. VLYNQ™ of Texas Instruments Incorporated. VXWORKS™, WIND RIVER™ of WIND RIVER SYSTEMS, INC. ZETEX™ of Diodes Zetex Limited.

Last Trademarks Update 2011-11-11

Table of Contents

	Table of Contents	4
	List of Figures	5
	List of Tables	6
1	LED Driver	7
1.1	Features	7
1.2	Applications	7
1.3	General Description	7
2	Electrical Characteristics	9
3	Typical characteristics	11
4	Application hints	23
5	Package	24
	Terminology	25

List of Figures

Figure 1-1	Pin configuration and typical application.	8
Figure 3-1	Total Power Dissipation $P_{tot} = f(T_S)$	11
Figure 3-2	Permissible Pulse Load $R_{thJS} = f(t_p)$	11
Figure 3-3	Permissible Pulse Load $P_{totmax} / P_{totDC} = f(t_p)$	12
Figure 3-4	BCR 420U: Output Current versus $V_{out} I_{out} = f(V_{out})$, $V_{EN} = 40\text{ V}$, $R_{ext} = \text{Parameter}$	13
Figure 3-5	BCR 420U: Output Current versus $R_{ext} I_{out} = f(R_{ext})$, $V_{EN} = 40\text{ V}$, $V_{out} = \text{Parameter}$	13
Figure 3-6	BCR 420U: Output Current versus $V_{out} I_{out} = f(V_{out})$, $V_{EN} = 40\text{ V}$, $R_{ext} = \text{open}$, $T_A = \text{Parameter}$	14
Figure 3-7	BCR 420U: Output Current versus $V_{out} I_{out} = f(V_{out})$, $V_{EN} = 40\text{ V}$, $R_{ext} = 20\ \Omega$, $T_A = \text{Parameter}$	14
Figure 3-8	BCR 420U: Output Current versus $V_{out} I_{out} = f(V_{out})$, $V_{EN} = 40\text{ V}$, $R_{ext} = 6\ \Omega$, $T_A = \text{Parameter}$	15
Figure 3-9	BCR 420U: Output Current versus $V_{EN} I_{out} = f(V_{EN})$, $V_{out} = 2\text{ V}$, $R_{ext} = \text{open}$, $T_A = \text{Parameter}$	15
Figure 3-10	BCR 420U: Output Current versus $V_{EN} I_{out} = f(V_{EN})$, $V_{out} = 2\text{ V}$, $R_{ext} = 20\ \Omega$, $T_A = \text{Parameter}$	16
Figure 3-11	BCR 420U: Output Current versus $V_{EN} I_{out} = f(V_{EN})$, $V_{out} = 2\text{ V}$, $R_{ext} = 6\ \Omega$, $T_A = \text{Parameter}$	16
Figure 3-12	BCR 420U: Output Current versus $V_{EN} I_{out} = f(V_{EN})$, $V_{out} = 2\text{ V}$, $R_{ext} = \text{Parameter}$	17
Figure 3-13	BCR 420U: Enable Current versus $V_{EN} I_{EN} = f(V_{EN})$, $R_{ext} = \text{open}$, $I_{out} = 0\text{ A}$, $T_A = \text{Parameter}$	17
Figure 3-14	BCR 421U: Output Current versus $V_{out} I_{out} = f(V_{out})$, $V_{EN} = 3.3\text{ V}$, $R_{ext} = \text{Parameter}$	18
Figure 3-15	BCR 421U: Output Current versus $R_{ext} I_{out} = f(R_{ext})$, $V_{EN} = 3.3\text{ V}$, $V_{out} = \text{Parameter}$	18
Figure 3-16	BCR 421U: Output Current versus $V_{out} I_{out} = f(V_{out})$, $V_{EN} = 3.3\text{ V}$, $R_{ext} = \text{open}$, $T_A = \text{Parameter}$	19
Figure 3-17	BCR 421U: Output Current versus $V_{out} I_{out} = f(V_{out})$, $V_{EN} = 3.3\text{ V}$, $R_{ext} = 20\ \Omega$, $T_A = \text{Parameter}$	19
Figure 3-18	BCR 421U: Output Current versus $V_{out} I_{out} = f(V_{out})$, $V_{EN} = 3.3\text{ V}$, $R_{ext} = 6\ \Omega$, $T_A = \text{Parameter}$	20
Figure 3-19	BCR 421U: Output Current versus $V_{EN} I_{out} = f(V_{EN})$, $V_{out} = 2\text{ V}$, $R_{ext} = \text{open}$, $T_A = \text{Parameter}$	20
Figure 3-20	BCR 421U: Output Current versus $V_{EN} I_{out} = f(V_{EN})$, $V_{out} = 2\text{ V}$, $R_{ext} = 20\ \Omega$, $T_A = \text{Parameter}$	21
Figure 3-21	BCR 421U: Output Current versus $V_{EN} I_{out} = f(V_{EN})$, $V_{out} = 2\text{ V}$, $R_{ext} = 6\ \Omega$, $T_A = \text{Parameter}$	21
Figure 3-22	BCR 421U: Output Current versus $V_{EN} I_{out} = f(V_{EN})$, $V_{out} = 2\text{ V}$, $R_{ext} = \text{Parameter}$	22
Figure 3-23	BCR 421U: Enable Current versus $V_{EN} I_{EN} = f(V_{EN})$, $R_{ext} = \text{open}$, $I_{out} = 0\text{ A}$, $T_A = \text{Parameter}$	22
Figure 4-1	Application Circuit: Enabling / PWM by Micro Controller	23
Figure 4-2	Application Circuit: Enabling by Connecting to V_S	23
Figure 5-1	Package Outline for SC74 (dimensions in mm)	24
Figure 5-2	Package Footprint for SC74 (dimensions in mm).	24
Figure 5-3	Tape and Reel Information for SC74 (dimensions in mm)	24

List of Tables

Table 2-1	Maximum Ratings at $T_A = 25\text{ °C}$, unless otherwise specified	9
Table 2-2	Thermal Resistance at $T_A = 25\text{ °C}$, unless otherwise specified	9
Table 2-3	Electrical Characteristics at $T_A = 25\text{ °C}$, unless otherwise specified	9
Table 2-4	DC Characteristics with stabilized LED load at $T_A = 25\text{ °C}$, unless otherwise specified	10

1 LED Driver

1.1 Features

- LED drive current preset to 10 mA
- Continuous output current up to 150 mA with an external resistor
- Easy paralleling of drivers to increase current
- Supply voltage up to 40 V
- Low side current control
- Digital PWM input up to 10 kHz frequency (BCR 421U E6327)
- Up to 1 W power dissipation in a small SC74 package
- Negative thermal coefficient of -0.2 %/K reduces output current at higher temperatures
- RoHS compliant (Pb-free) package
- Automotive qualified according AEC Q101



SC74-3D



1.2 Applications

- Architectural LED lighting
- Channel letters for advertising, LED strips for decorative lighting
- Retail lighting in fridge, freezer case and vending machines
- Emergency lighting (e.g. steps lighting, exit way signs etc.)

1.3 General Description

The BCR 420U E6327 / BCR 421U E6327 provides a low-cost solution for driving 0.25 W LEDs with a typical LED current of 75 mA to 150 mA. Internal breakdown voltage is higher than 40 V which is the maximum voltage the LED driver can sustain when the output is directly connected to supply voltage.

The BCR 420U E6327 / BCR 421U E6327 can be operated with a supply voltage of more than 40 V considering the voltage drop of the LED load which reduces the output voltage to the maximum rating of the driver.

The enable pin of BCR 420U E6327 can withstand a maximum voltage of 40 V which can be increased adding a series resistor in front of the enable pin reducing the voltage at the enable pin below 40 V.

The digital input pin of BCR 421U E6327 allows dimming via a micro controller with frequencies up to 10 kHz.

A reduction of the output current at higher temperatures is the result of the negative temperature coefficient of -0.2 %/K of the LED driver.

With no need for additional external components like inductors, capacitors and free wheeling diodes, the BCR 420U E6327 / BCR 421U E6327 LED drivers are a cost-efficient and PCB-area saving solution for driving 0.25 W LEDs.

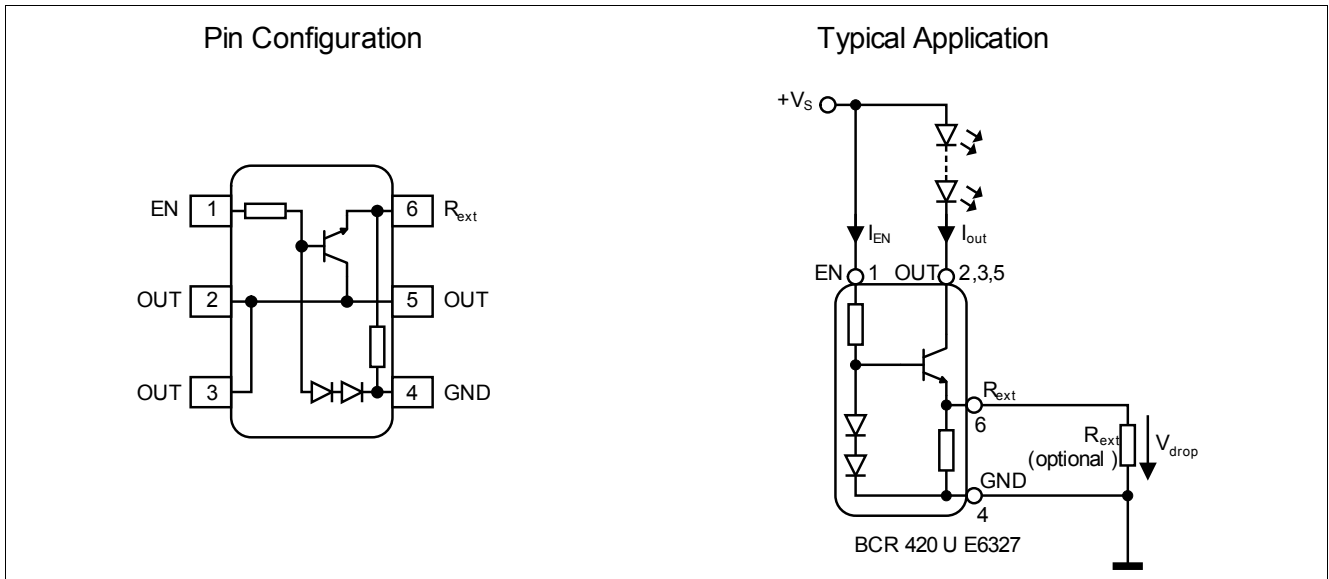

Figure 1-1 Pin configuration and typical application

Sales Name	Marking	Pin Configuration				Package
		1 = EN	2; 3; 5 = OUT	4 = GND	6 = R _{ext}	
BCR 420U E6327	40	1 = EN	2; 3; 5 = OUT	4 = GND	6 = R _{ext}	SC74
BCR 421U E6327	41	1 = EN	2; 3; 5 = OUT	4 = GND	6 = R _{ext}	SC74

2 Electrical Characteristics

Table 2-1 Maximum Ratings at $T_A = 25\text{ °C}$, unless otherwise specified

Parameter	Symbol	Values			Unit	Note / Test Condition
		Min.	Typ.	Max.		
Enable voltage BCR 420U E6327 BCR 421U E6327	V_{EN}	-	-	40 4.5	V	
Output current	I_{out}	-	-	200	mA	
Output voltage	V_{out}	-	-	40	V	
Reverse voltage between all terminals	V_R	-	-	0.5	V	
Total power dissipation	P_{tot}	-	-	1000	mW	$T_S \leq 100\text{ °C}$
Junction temperature	T_J	-	-	150	°C	
Storage temperature range	T_{STG}	-65	-	150	°C	

Attention: Stresses above the max. values listed here may cause permanent damage to the device. Exposure to absolute maximum rating conditions for extended periods may affect device reliability. Maximum ratings are absolute ratings; exceeding only one of these values may cause irreversible damage to the integrated circuit.

Table 2-2 Thermal Resistance at $T_A = 25\text{ °C}$, unless otherwise specified

Parameter	Symbol	Values			Unit	Note / Test Condition
		Min.	Typ.	Max.		
Junction - soldering point ¹⁾	R_{thJS}	-	-	50	K/W	

1) For calculation of R_{thJA} please refer to Application Note AN077 (Thermal Resistance Calculation)

Table 2-3 Electrical Characteristics at $T_A = 25\text{ °C}$, unless otherwise specified

Parameter	Symbol	Values			Unit	Note / Test Condition
		Min.	Typ.	Max.		
Collector-emitter breakdown voltage	$V_{BR(CEO)}$	40	-	-	V	$I_C = 1\text{ mA}, I_B = 0$
Enable current BCR 420U E6327 BCR 421U E6327	I_{EN}	-	1.2 1.2	-	mA	$V_{EN} = 24\text{ V}$ $V_{EN} = 3.3\text{ V}$
DC current gain	h_{FE}	200	350	500	-	$I_C = 50\text{ mA}, V_{CE} = 1\text{ V}$
Internal resistor	R_{int}	85	95	105	Ω	$I_{Rint} = 10\text{ mA}$
Bias resistor BCR 420U E6327 BCR 421U E6327	R_B	-	20 1.5	-	k Ω	

Electrical Characteristics

Table 2-3 Electrical Characteristics at $T_A = 25\text{ °C}$, unless otherwise specified (cont'd)

Parameter	Symbol	Values			Unit	Note / Test Condition
		Min.	Typ.	Max.		
Output current BCR 420U E6327 BCR 421U E6327	I_{out}	9	10	11	mA	$V_{out} = 1.4\text{ V}$ $V_{EN} = 24\text{ V}$
Output current at $R_{ext} = 5.1\ \Omega$ BCR 420U E6327 BCR 421U E6327		9	10	11		$V_{EN} = 3.3\text{ V}$ $V_{out} > 2.0\text{ V}$
		-	150	-		$V_{EN} = 24\text{ V}$
		-	150	-		$V_{EN} = 3.3\text{ V}$
Voltage drop (V_{Rext})	V_{drop}	0.85	0.95	1.05	V	$I_{out} = 10\text{ mA}$

Table 2-4 DC Characteristics with stabilized LED load at $T_A = 25\text{ °C}$, unless otherwise specified

Parameter	Symbol	Values			Unit	Note / Test Condition
		Min.	Typ.	Max.		
Lowest sufficient supply voltage overhead	V_{Smin}	-	1.4	-	V	$I_{out} > 18\text{ mA}$
Output current change versus T_A BCR 420U E6327 BCR 421U E6327	$\Delta I_{out}/I_{out}$	-	-0.2	-	%K	$V_{out} > 2.0\text{ V}$ $V_{EN} = 24\text{ V}$
		-	-0.2	-		$V_{EN} = 3.3\text{ V}$
Output current change versus V_S BCR 420U E6327 BCR 421U E6327	$\Delta I_{out}/I_{out}$	-	1	-	%V	$V_{out} > 2.0\text{ V}$ $V_{EN} = 24\text{ V}$
		-	1	-		$V_{EN} = 3.3\text{ V}$

3 Typical characteristics

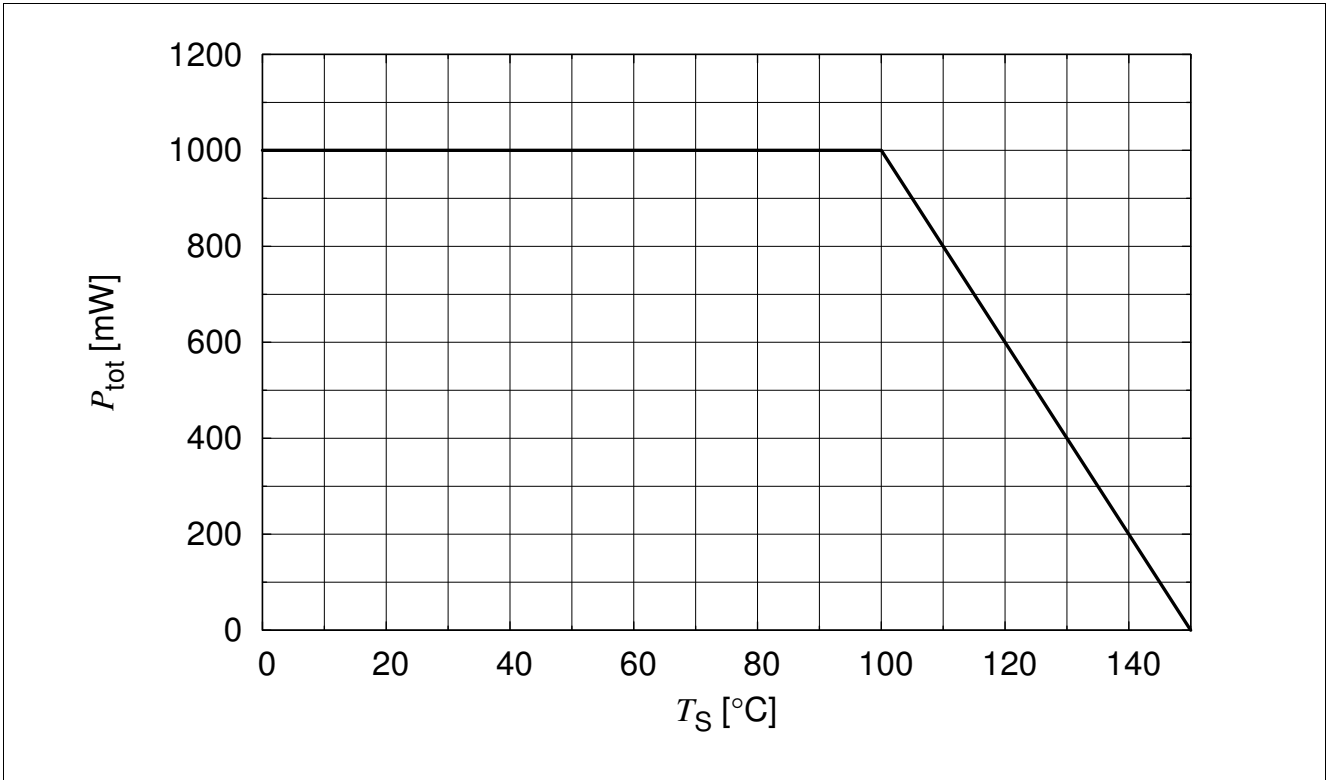

Figure 3-1 Total Power Dissipation $P_{tot} = f(T_S)$

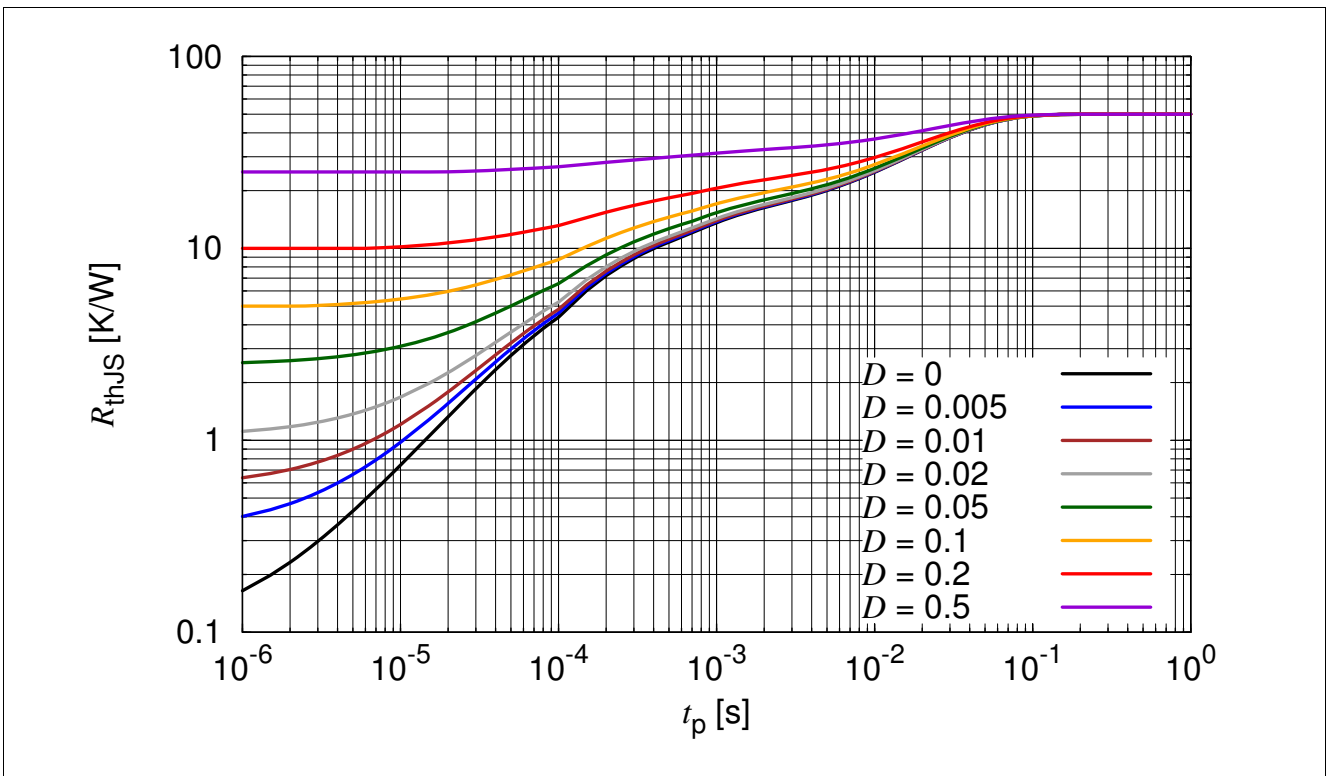

Figure 3-2 Permissible Pulse Load $R_{thJS} = f(t_p)$



Figure 3-3 Permissible Pulse Load $P_{totmax} / P_{totDC} = f(t_p)$

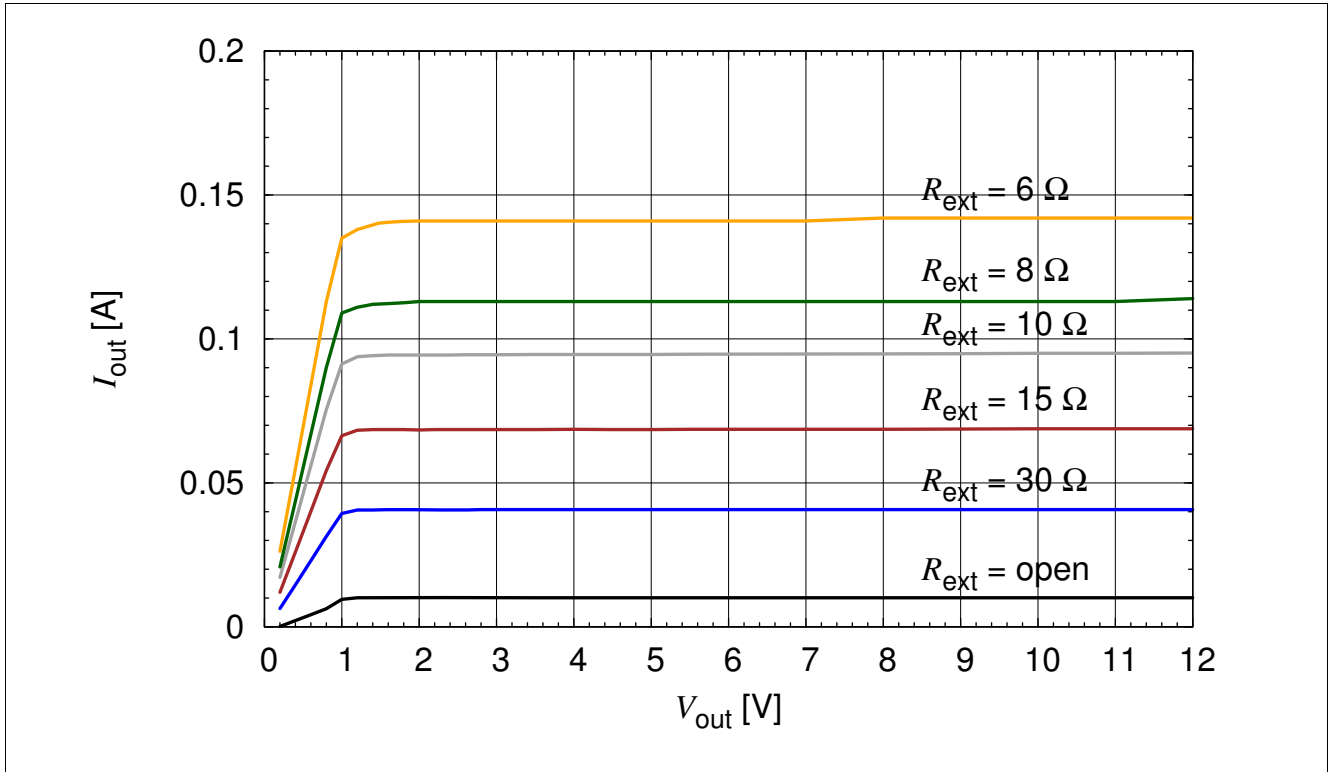

Figure 3-4 BCR 420U: Output Current versus V_{out} $I_{out} = f(V_{out})$, $V_{EN} = 40$ V, $R_{ext} =$ Parameter

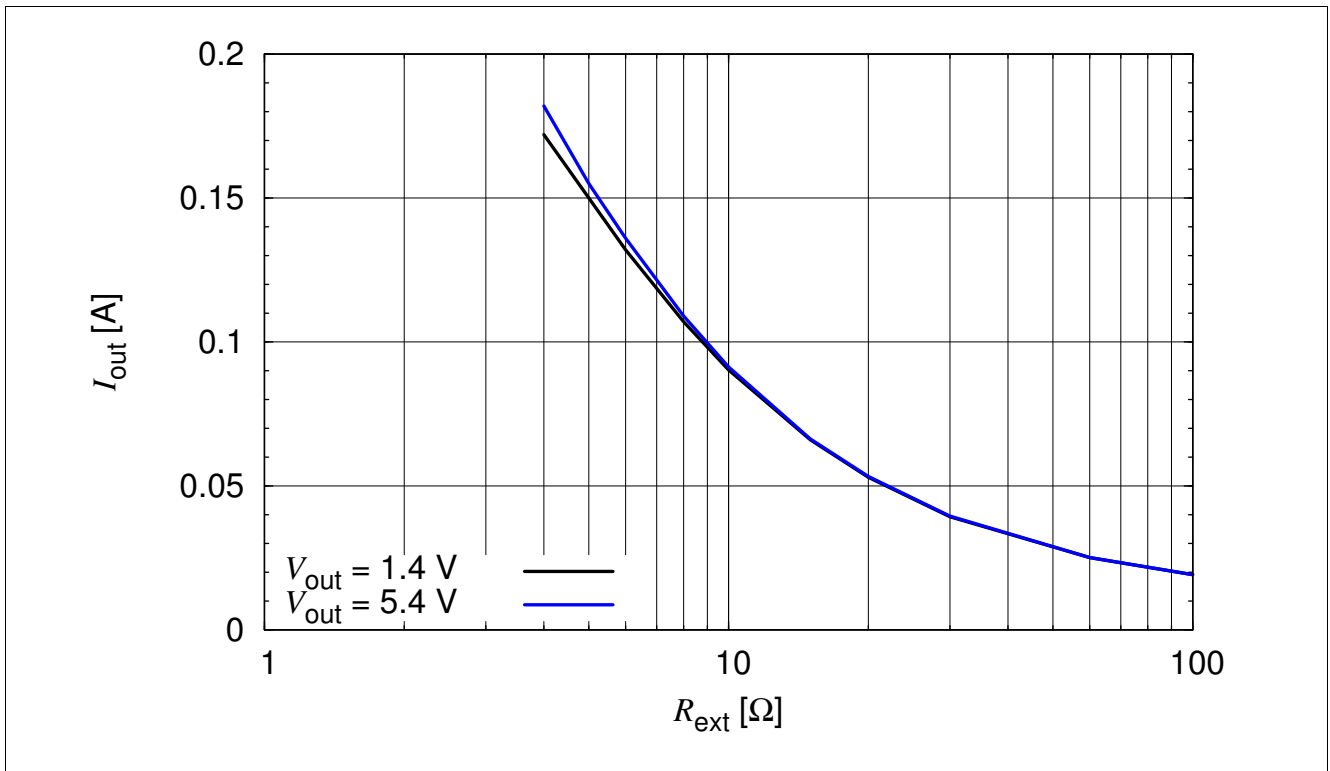

Figure 3-5 BCR 420U: Output Current versus R_{ext} $I_{out} = f(R_{ext})$, $V_{EN} = 40$ V, $V_{out} =$ Parameter

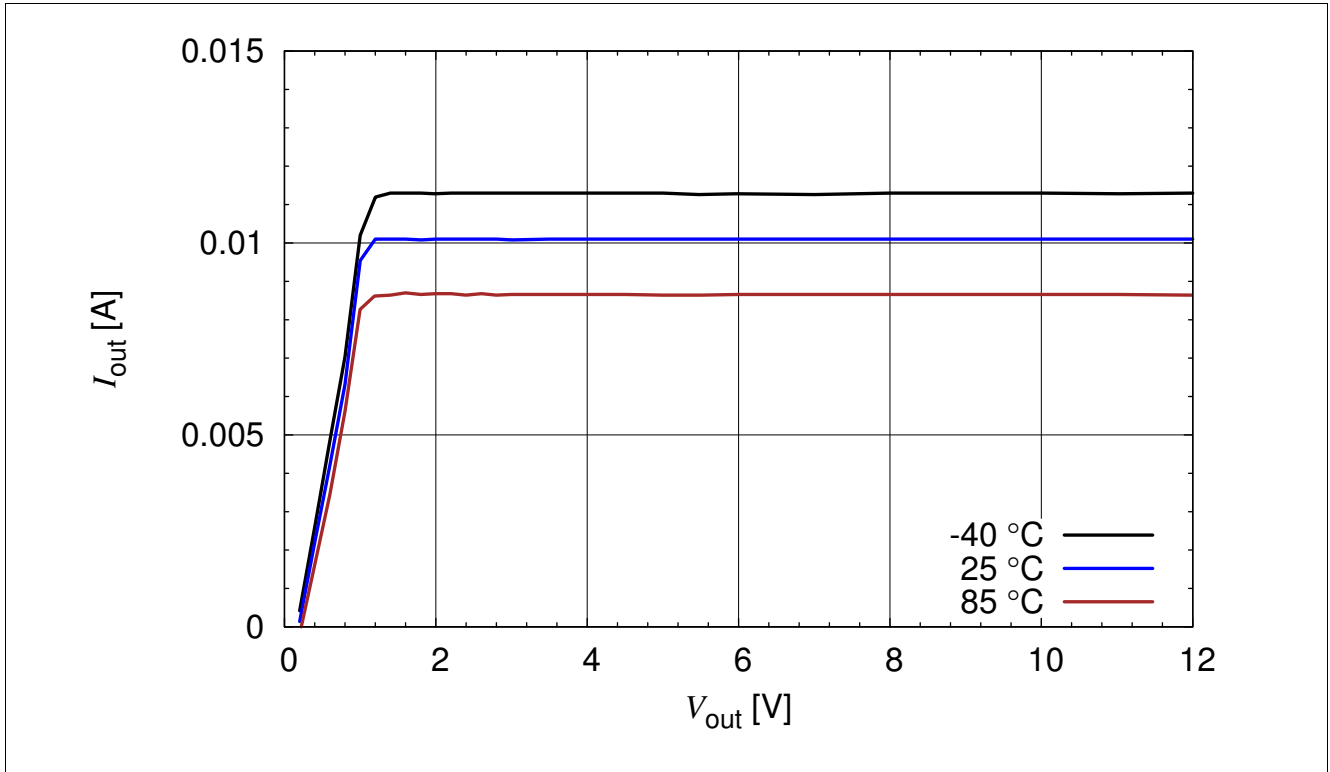

Figure 3-6 BCR 420U: Output Current versus V_{out} $I_{out} = f(V_{out})$, $V_{EN} = 40\text{ V}$, $R_{ext} = \text{open}$, $T_A = \text{Parameter}$

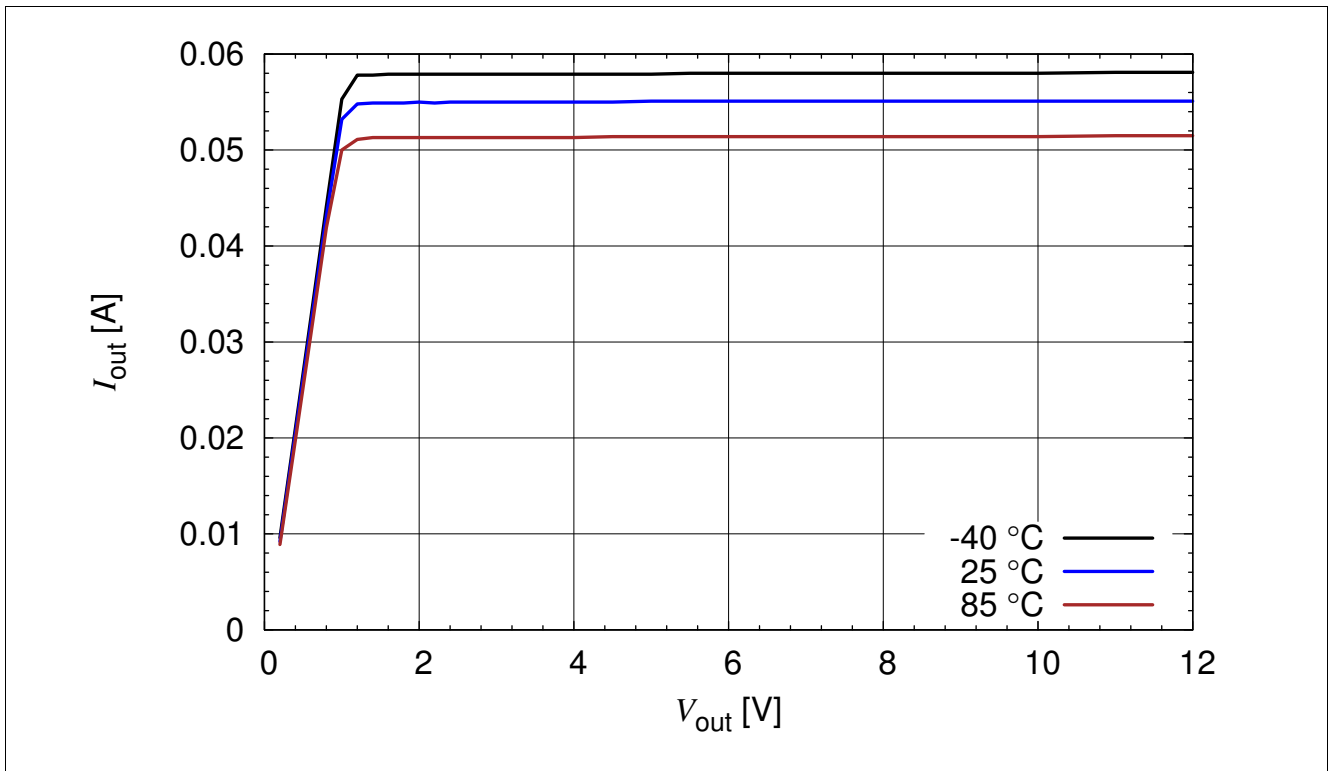

Figure 3-7 BCR 420U: Output Current versus V_{out} $I_{out} = f(V_{out})$, $V_{EN} = 40\text{ V}$, $R_{ext} = 20\ \Omega$, $T_A = \text{Parameter}$

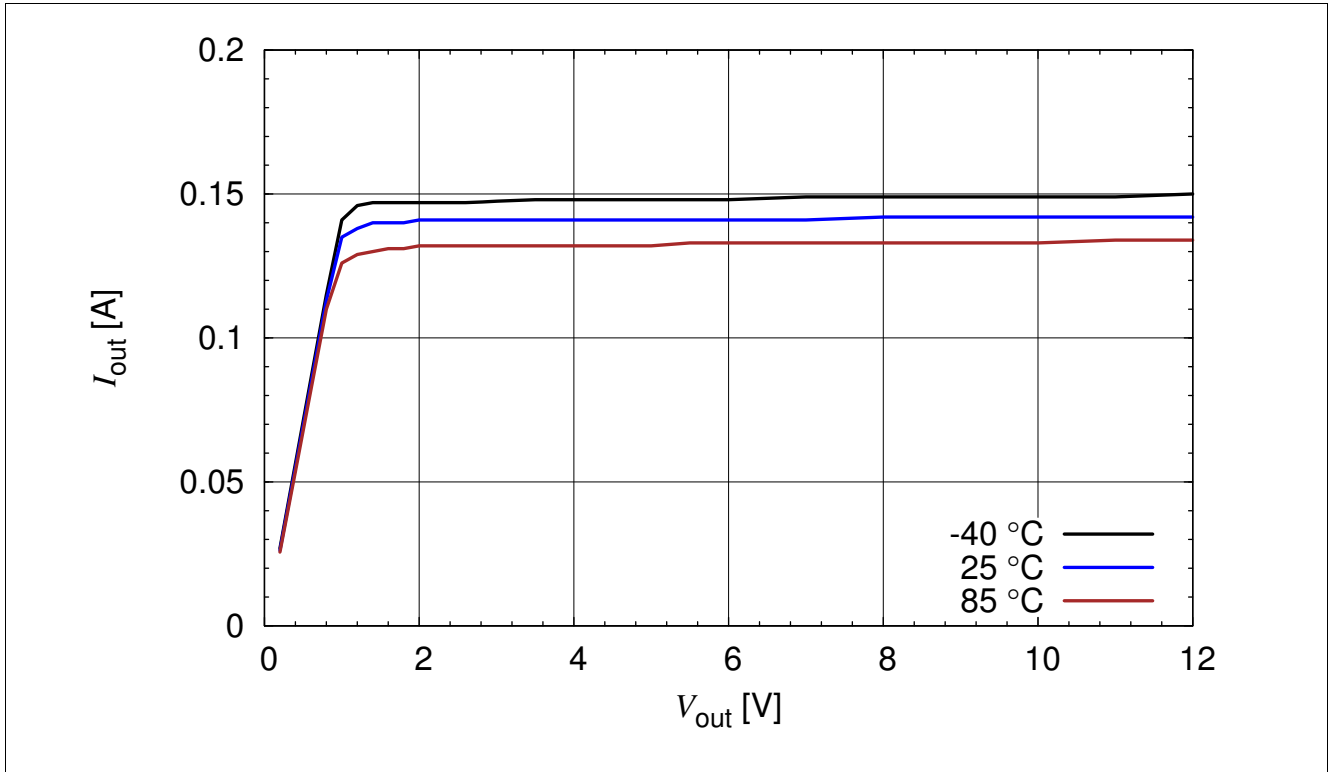

Figure 3-8 BCR 420U: Output Current versus V_{out} $I_{out} = f(V_{out})$, $V_{EN} = 40$ V, $R_{ext} = 6 \Omega$, $T_A =$ Parameter

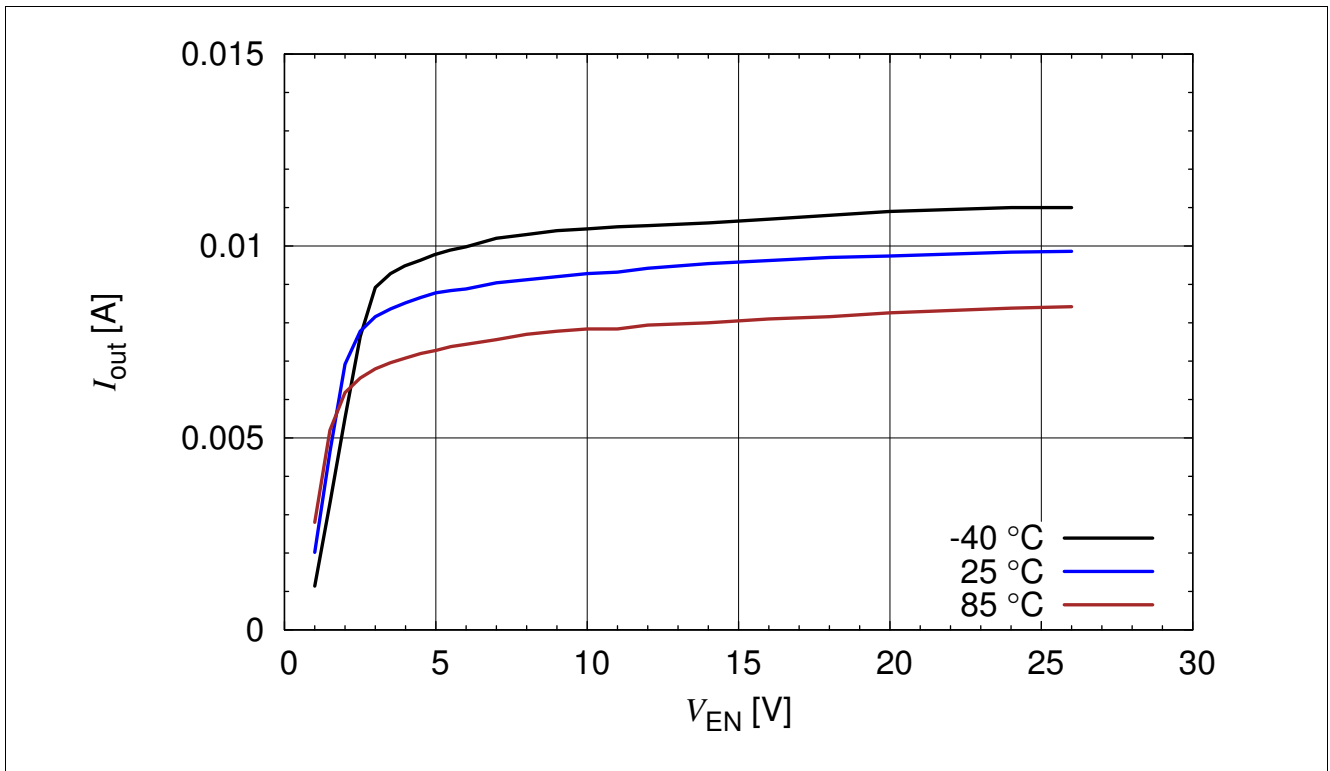

Figure 3-9 BCR 420U: Output Current versus V_{EN} $I_{out} = f(V_{EN})$, $V_{out} = 2$ V, $R_{ext} =$ open, $T_A =$ Parameter

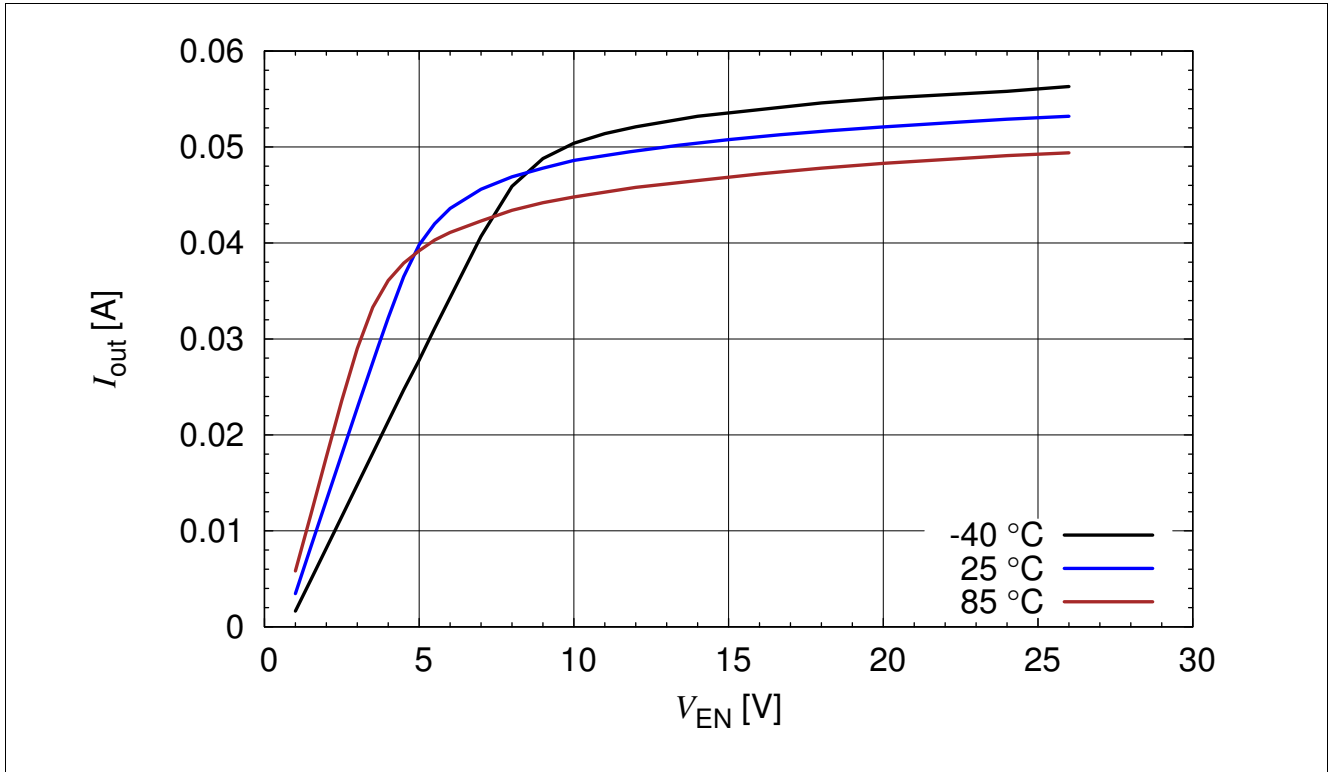

Figure 3-10 BCR 420U: Output Current versus V_{EN} $I_{out} = f(V_{EN})$, $V_{out} = 2\text{ V}$, $R_{ext} = 20\ \Omega$, $T_A = \text{Parameter}$

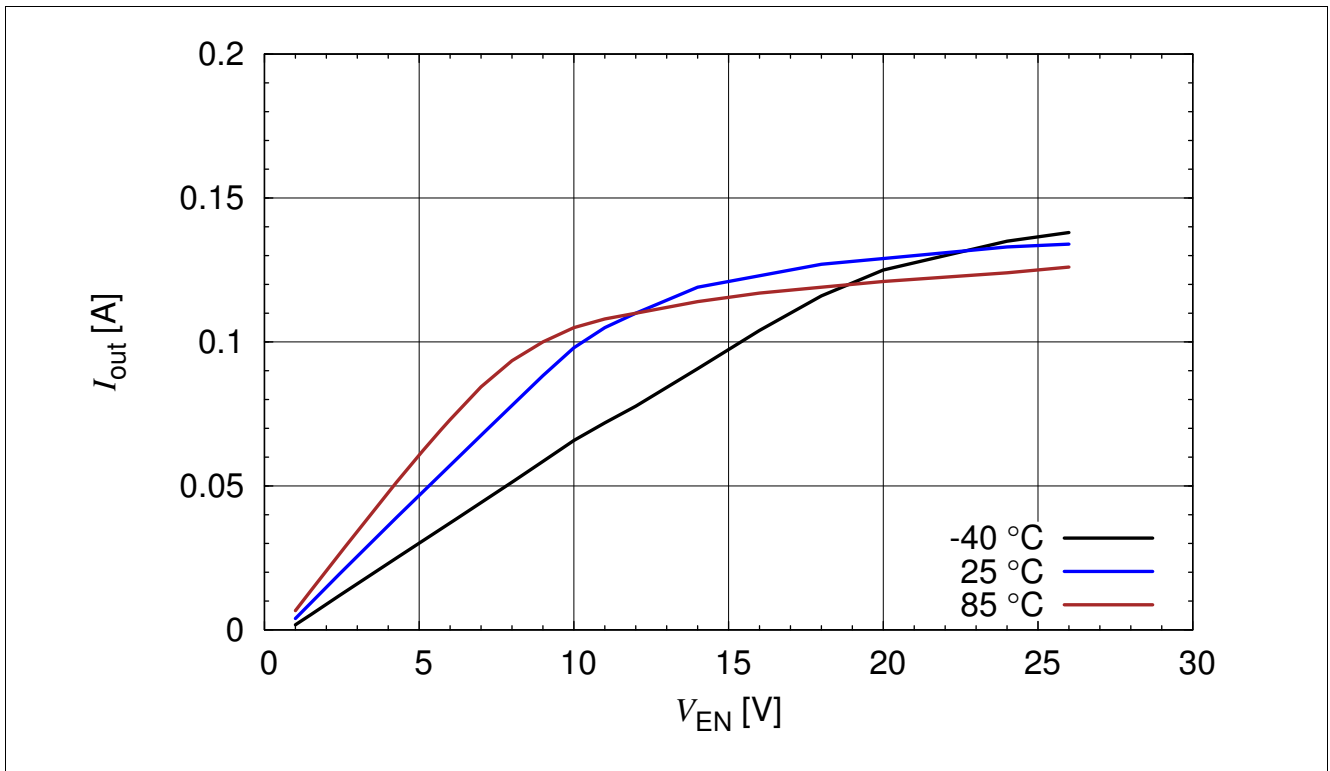

Figure 3-11 BCR 420U: Output Current versus V_{EN} $I_{out} = f(V_{EN})$, $V_{out} = 2\text{ V}$, $R_{ext} = 6\ \Omega$, $T_A = \text{Parameter}$

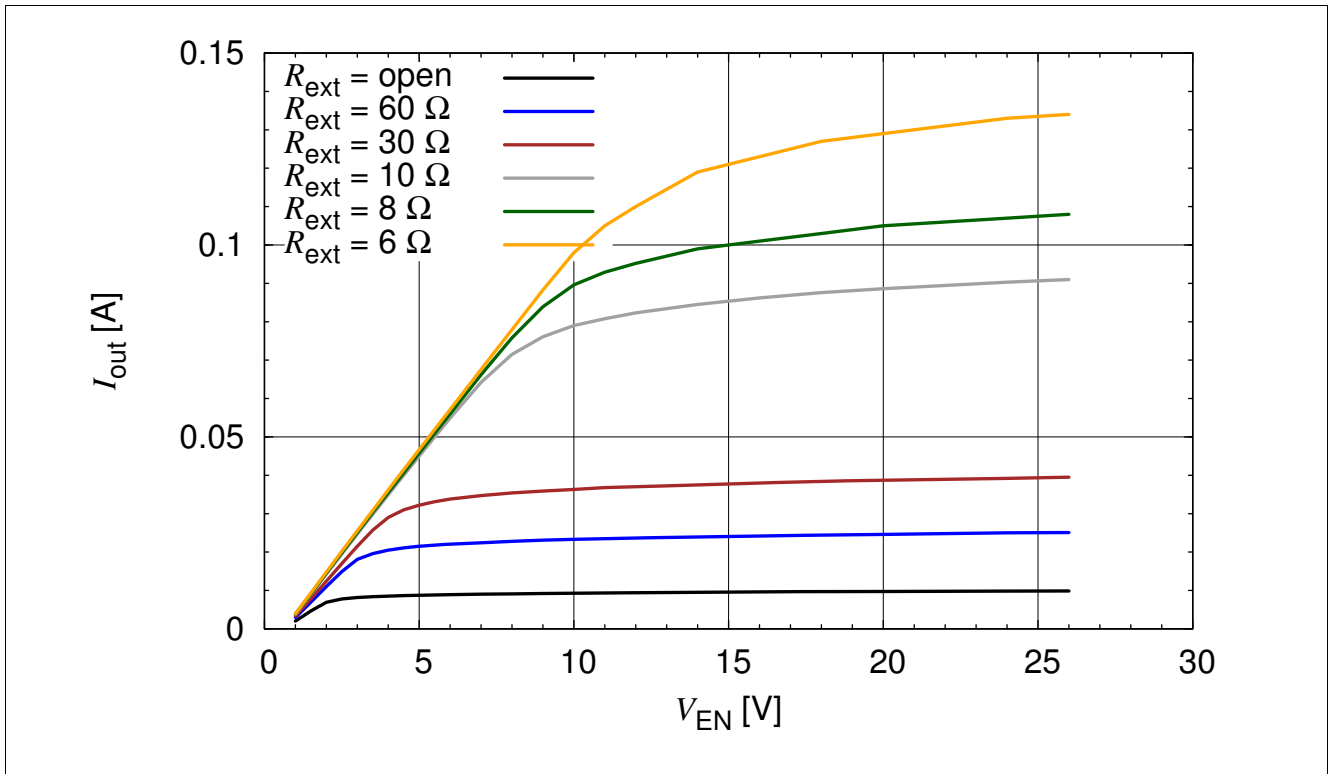

Figure 3-12 BCR 420U: Output Current versus V_{EN} $I_{out} = f(V_{EN})$, $V_{out} = 2\text{ V}$, $R_{ext} = \text{Parameter}$

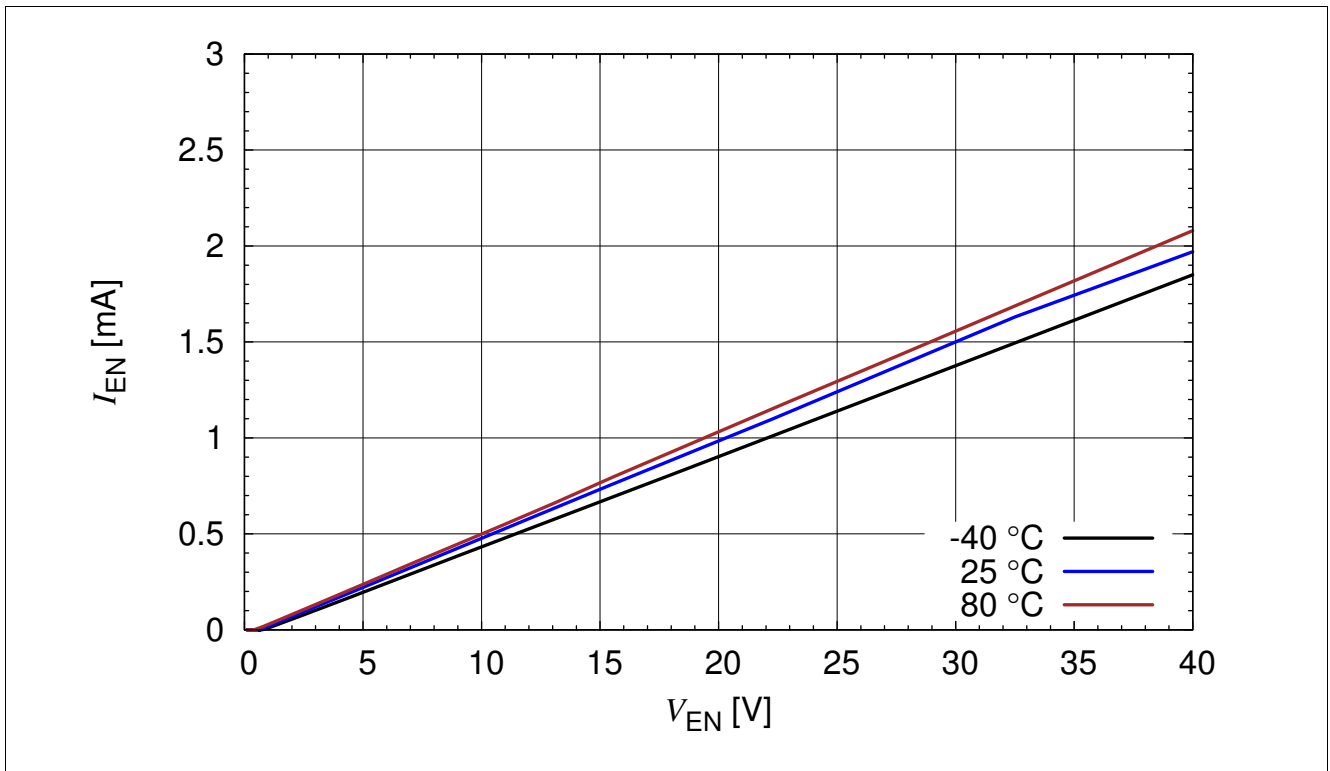

Figure 3-13 BCR 420U: Enable Current versus V_{EN} $I_{EN} = f(V_{EN})$, $R_{ext} = \text{open}$, $I_{out} = 0\text{ A}$, $T_A = \text{Parameter}$

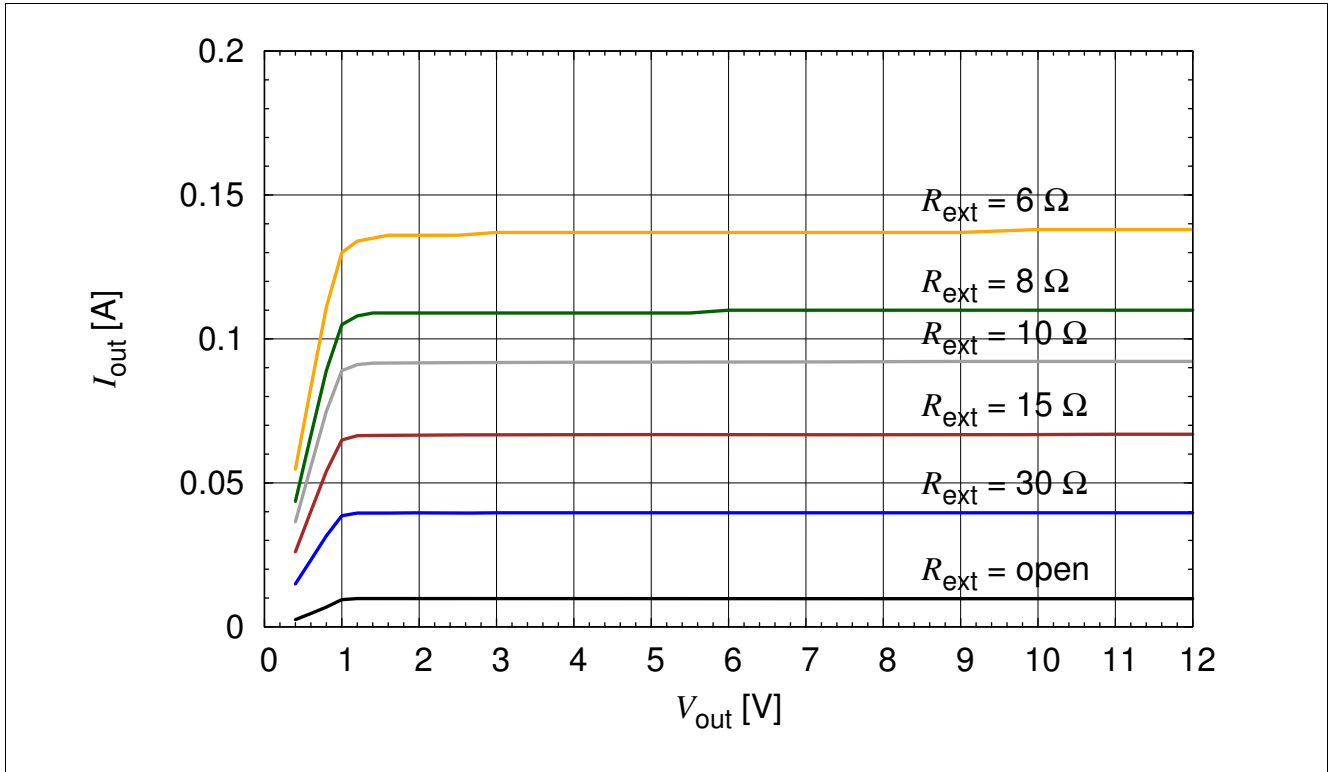

Figure 3-14 BCR 421U: Output Current versus V_{out} $I_{out} = f(V_{out})$, $V_{EN} = 3.3$ V, $R_{ext} =$ Parameter

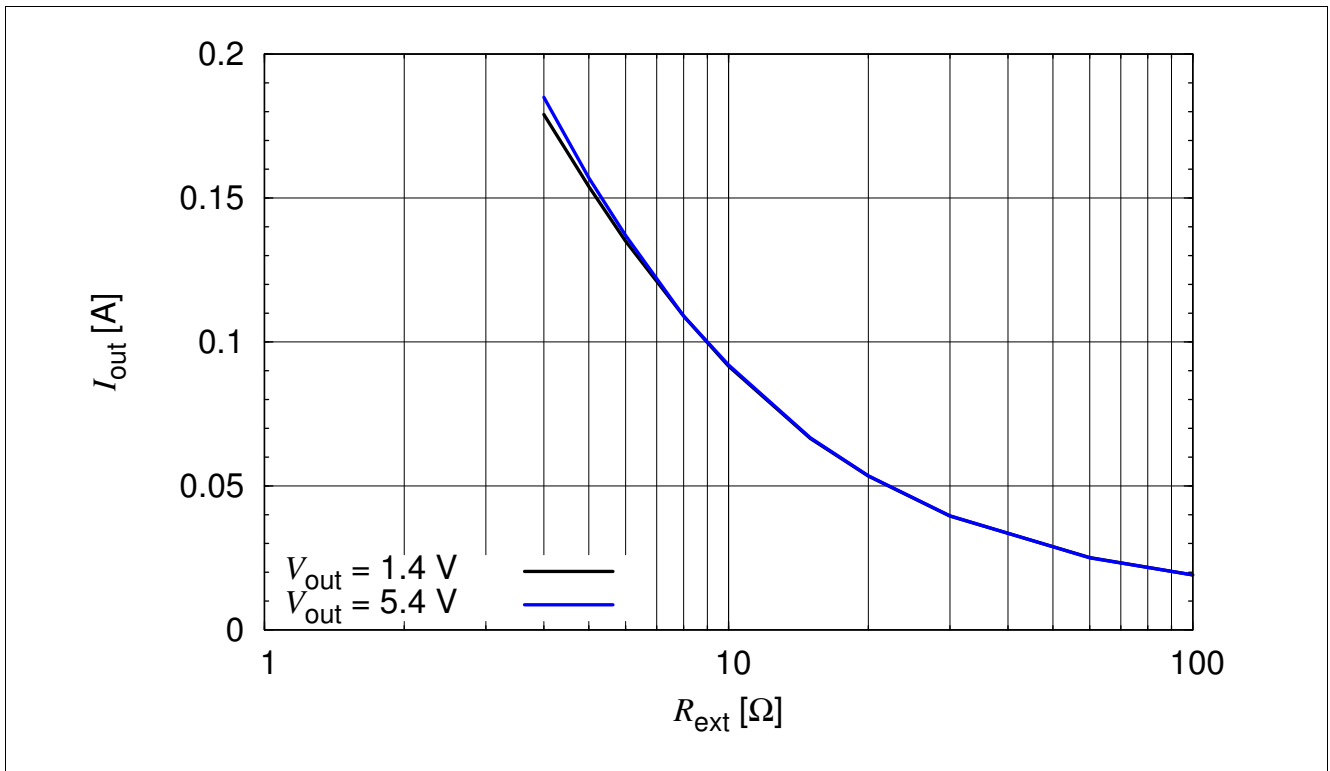

Figure 3-15 BCR 421U: Output Current versus R_{ext} $I_{out} = f(R_{ext})$, $V_{EN} = 3.3$ V, $V_{out} =$ Parameter

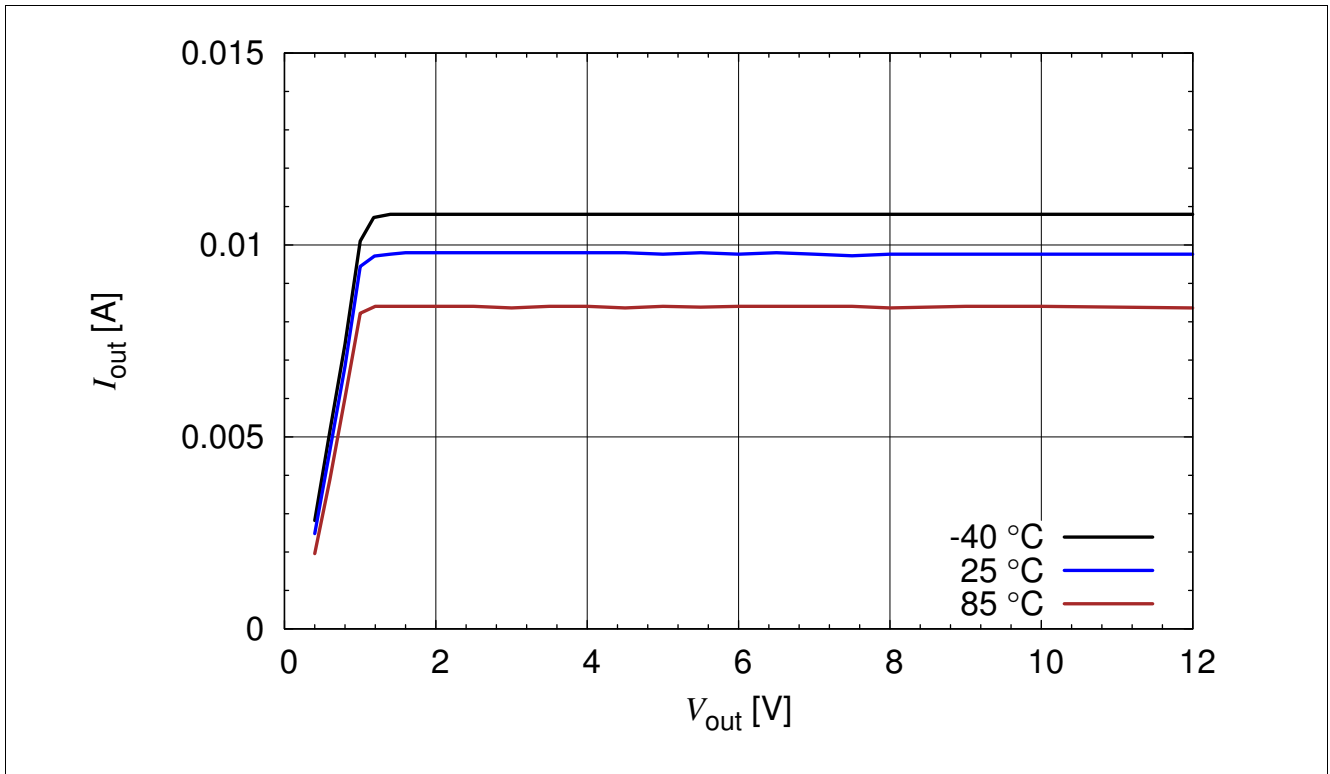

Figure 3-16 BCR 421U: Output Current versus V_{out} $I_{out} = f(V_{out})$, $V_{EN} = 3.3\text{ V}$, $R_{ext} = \text{open}$, $T_A = \text{Parameter}$

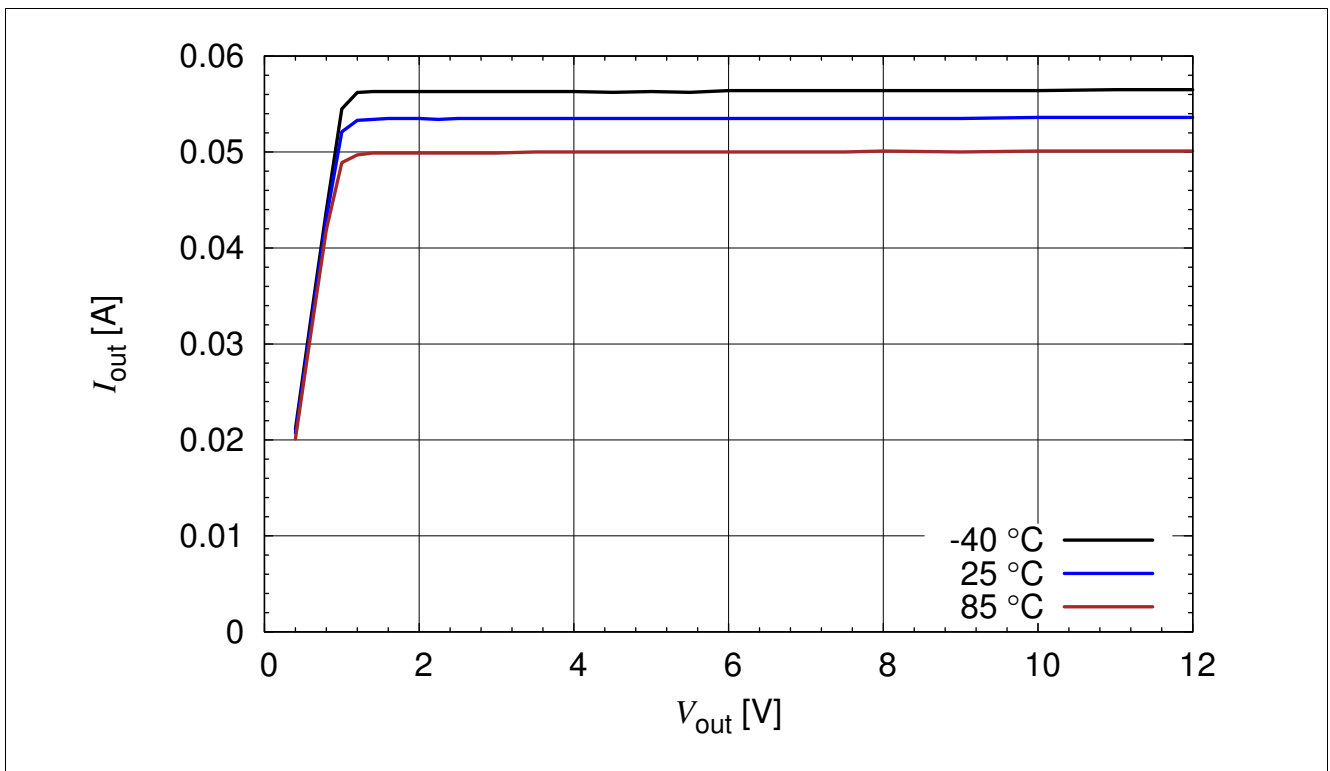

Figure 3-17 BCR 421U: Output Current versus V_{out} $I_{out} = f(V_{out})$, $V_{EN} = 3.3\text{ V}$, $R_{ext} = 20\ \Omega$, $T_A = \text{Parameter}$

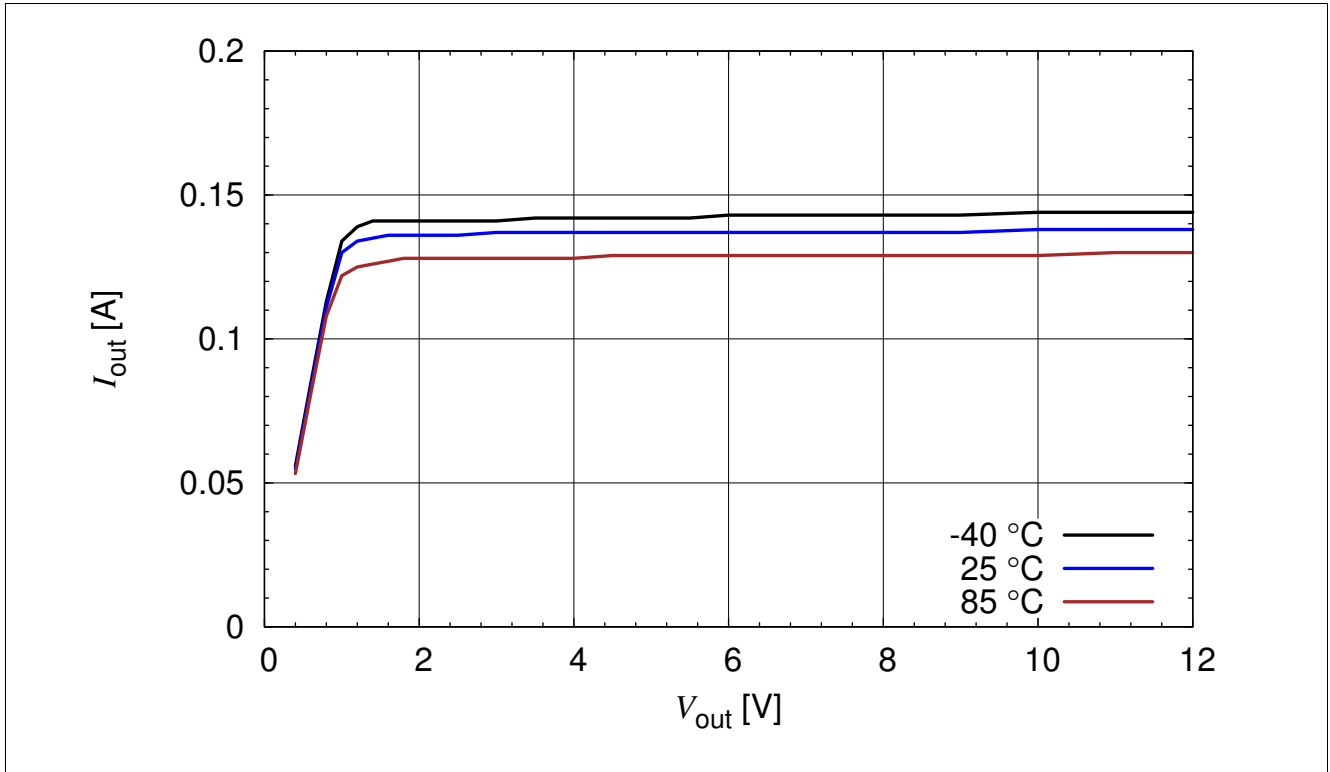

Figure 3-18 BCR 421U: Output Current versus V_{out} $I_{out} = f(V_{out})$, $V_{EN} = 3.3$ V, $R_{ext} = 6 \Omega$, $T_A =$ Parameter

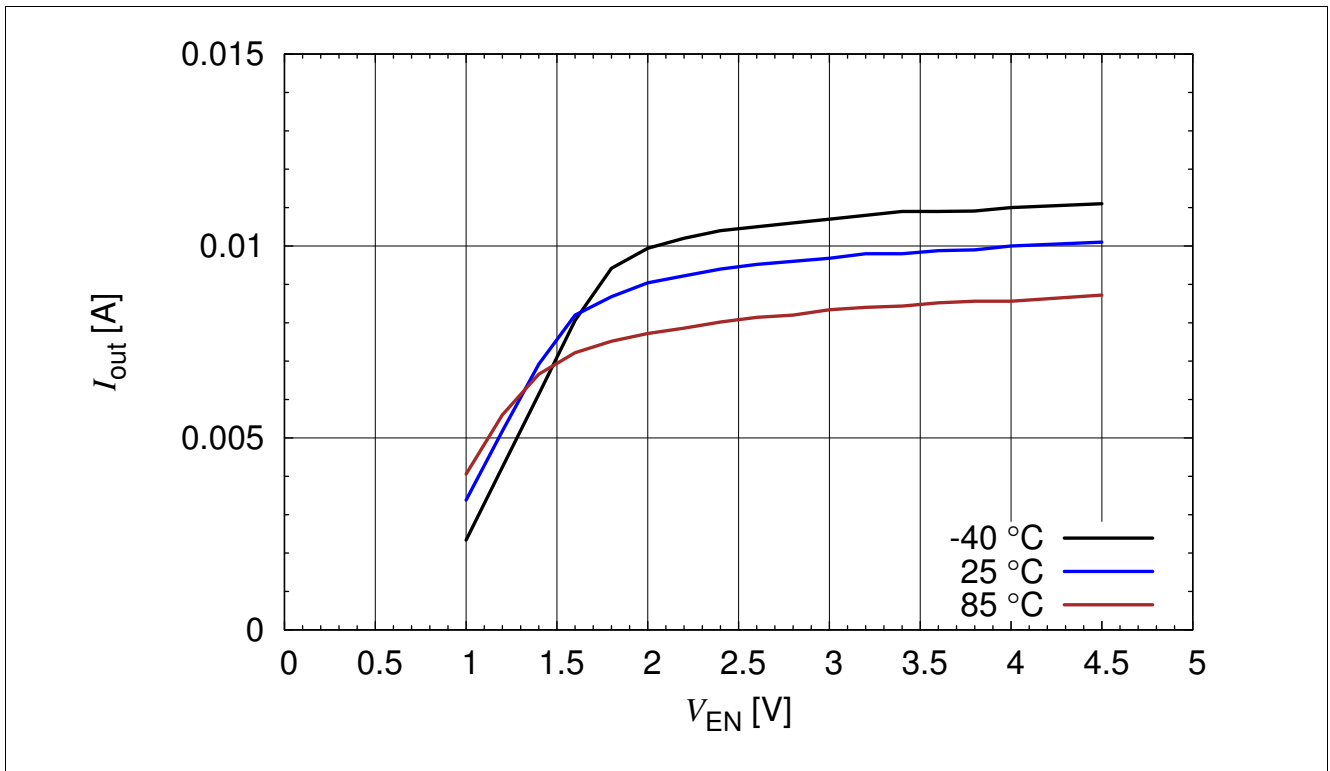

Figure 3-19 BCR 421U: Output Current versus V_{EN} $I_{out} = f(V_{EN})$, $V_{out} = 2$ V, $R_{ext} =$ open, $T_A =$ Parameter

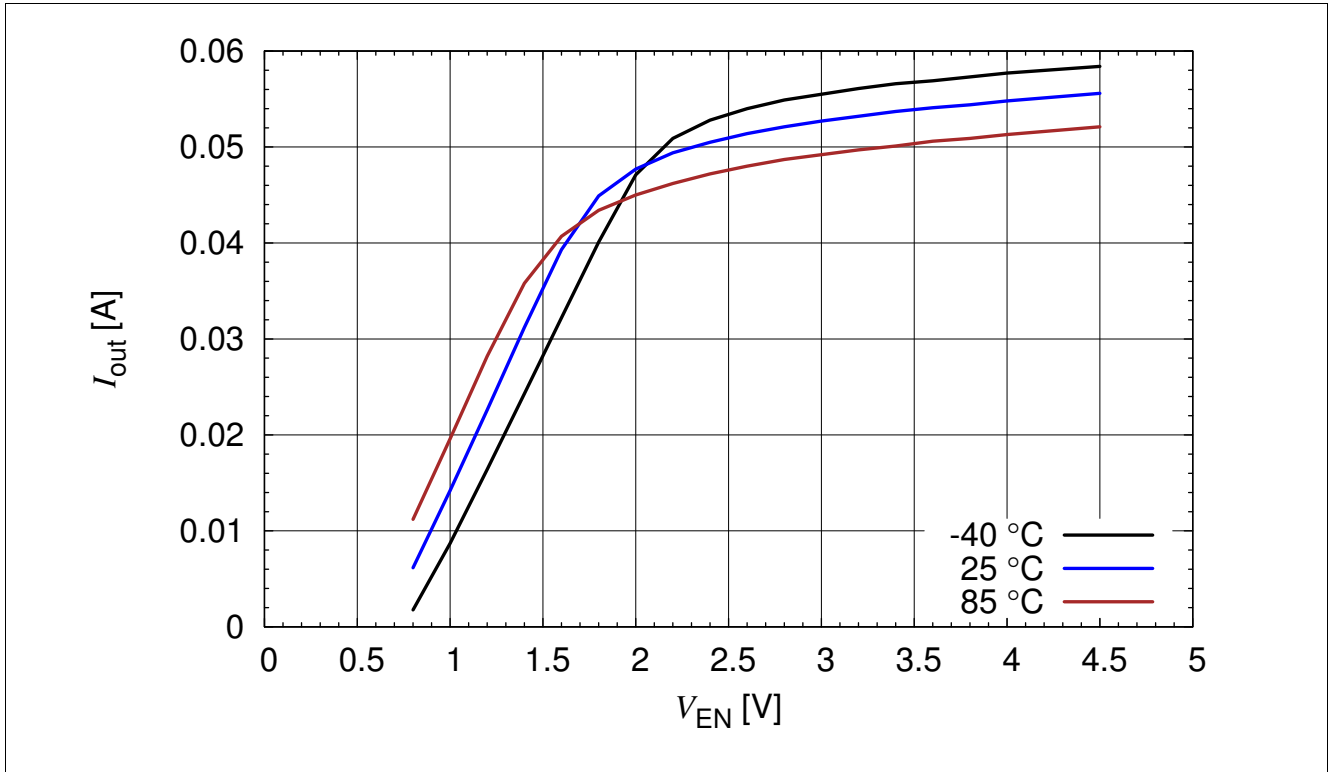

Figure 3-20 BCR 421U: Output Current versus V_{EN} $I_{out} = f(V_{EN})$, $V_{out} = 2\text{ V}$, $R_{ext} = 20\ \Omega$, $T_A = \text{Parameter}$

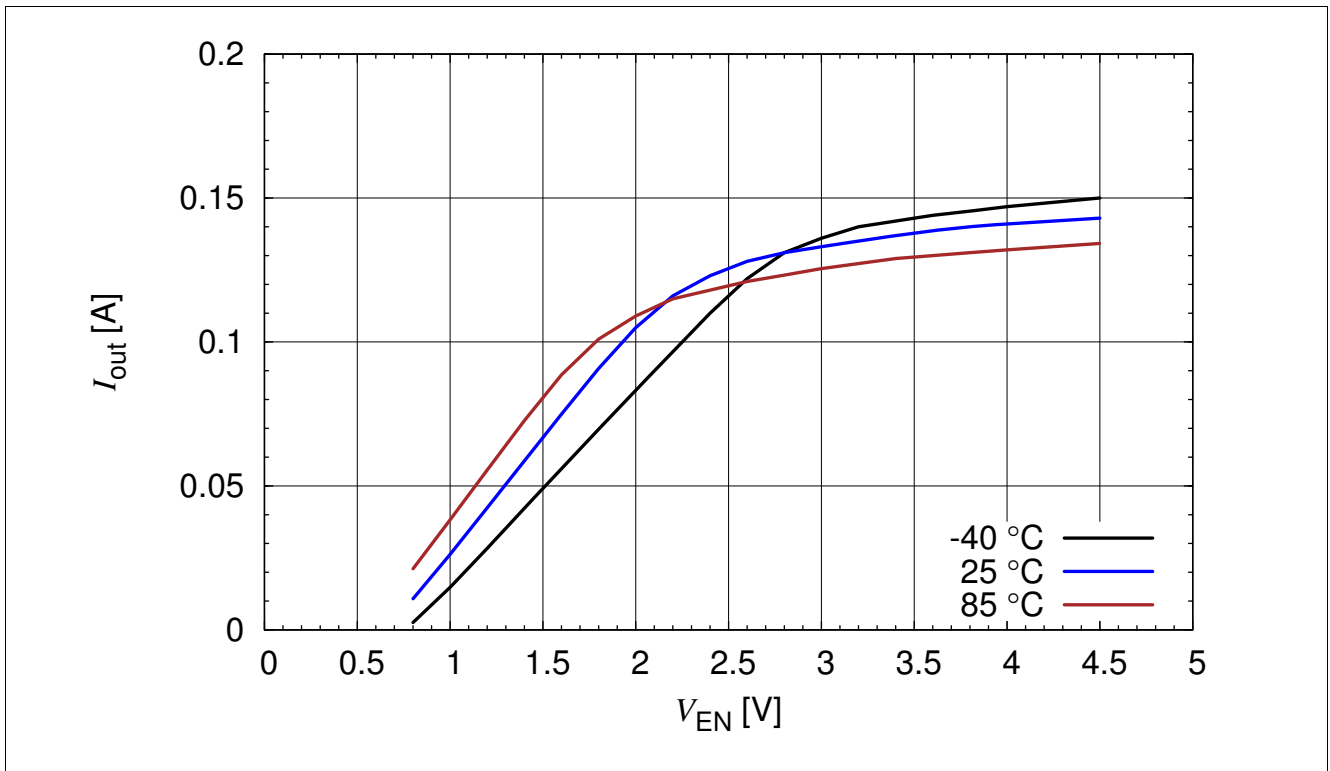

Figure 3-21 BCR 421U: Output Current versus V_{EN} $I_{out} = f(V_{EN})$, $V_{out} = 2\text{ V}$, $R_{ext} = 6\ \Omega$, $T_A = \text{Parameter}$

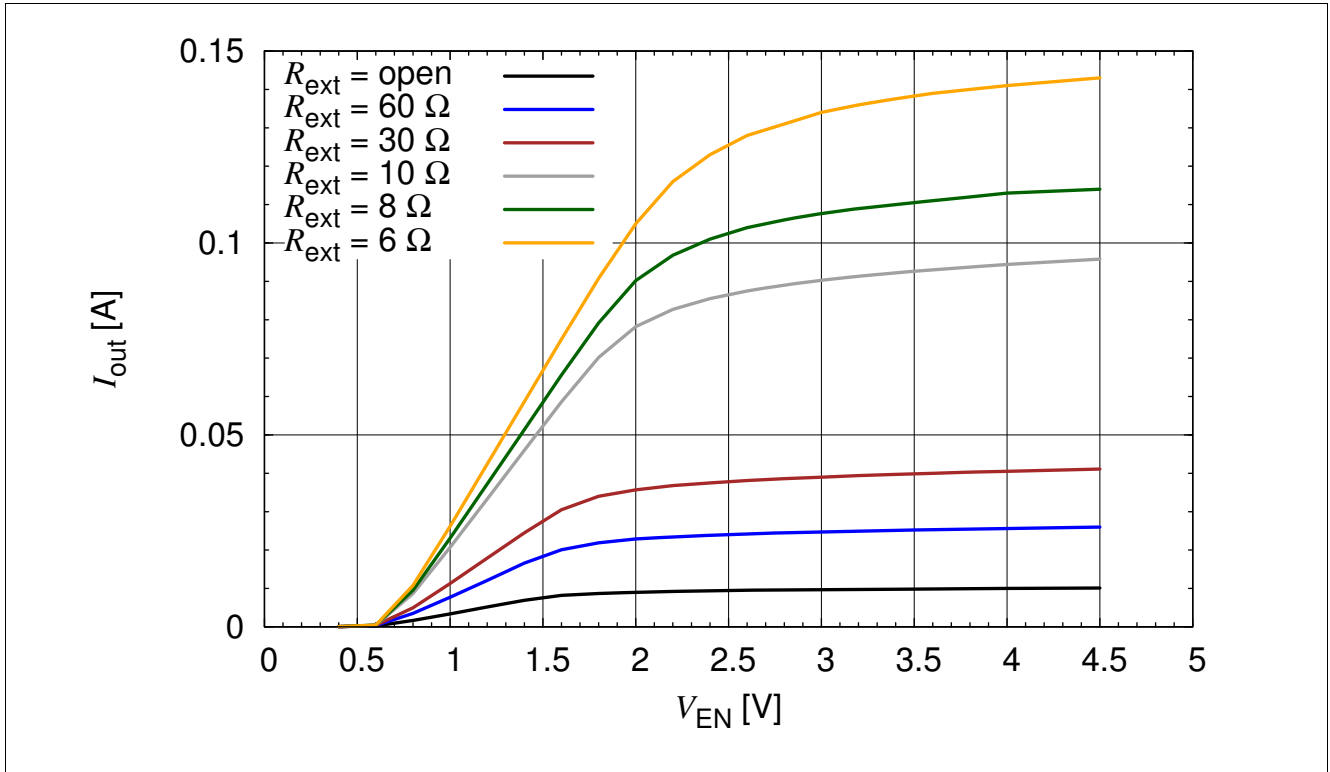

Figure 3-22 BCR 421U: Output Current versus V_{EN} $I_{out} = f(V_{EN})$, $V_{out} = 2 \text{ V}$, $R_{ext} = \text{Parameter}$

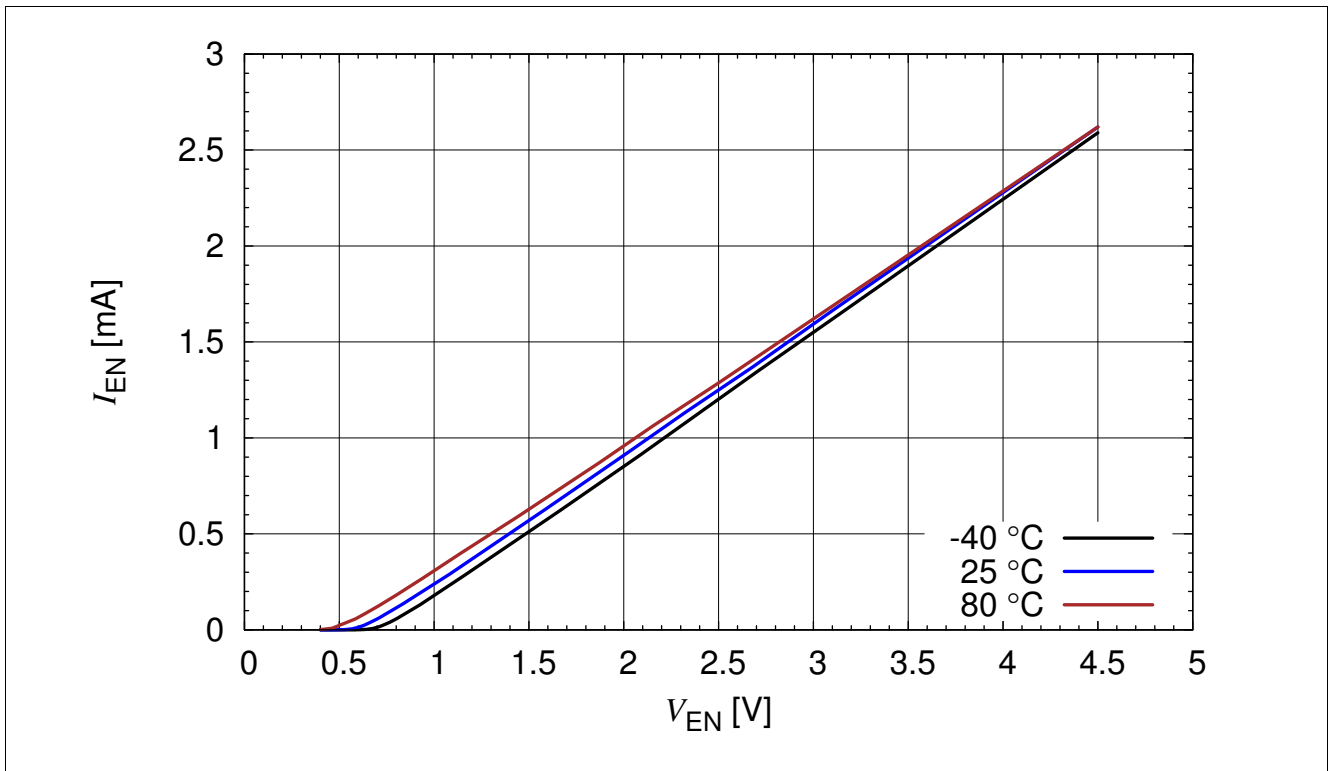

Figure 3-23 BCR 421U: Enable Current versus V_{EN} $I_{EN} = f(V_{EN})$, $R_{ext} = \text{open}$, $I_{out} = 0 \text{ A}$, $T_A = \text{Parameter}$

4 Application hints

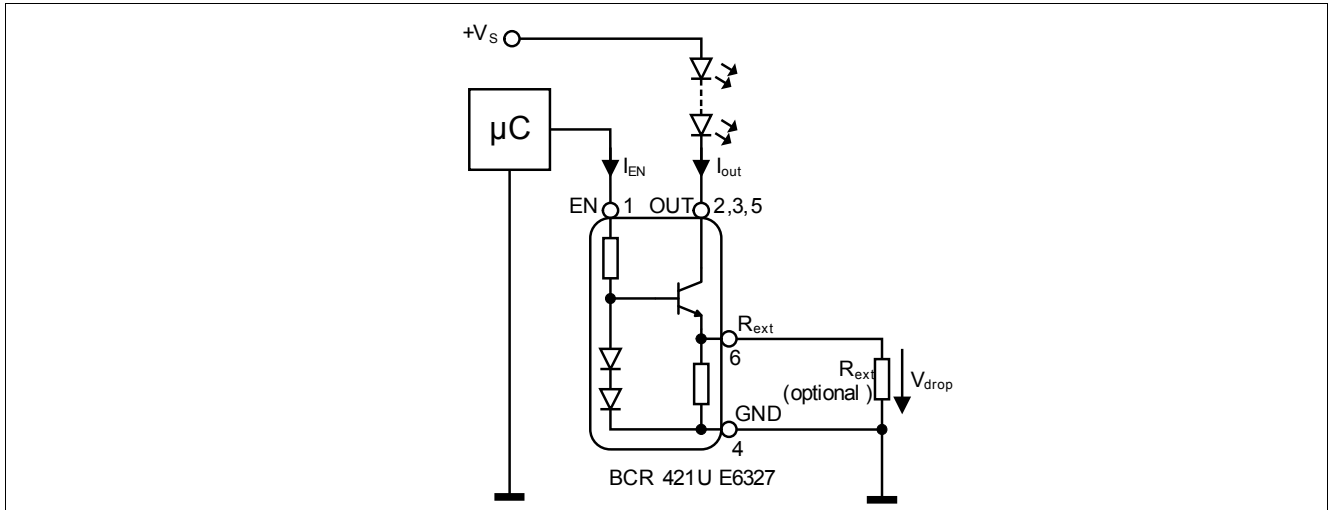

Figure 4-1 Application Circuit: Enabling / PWM by Micro Controller

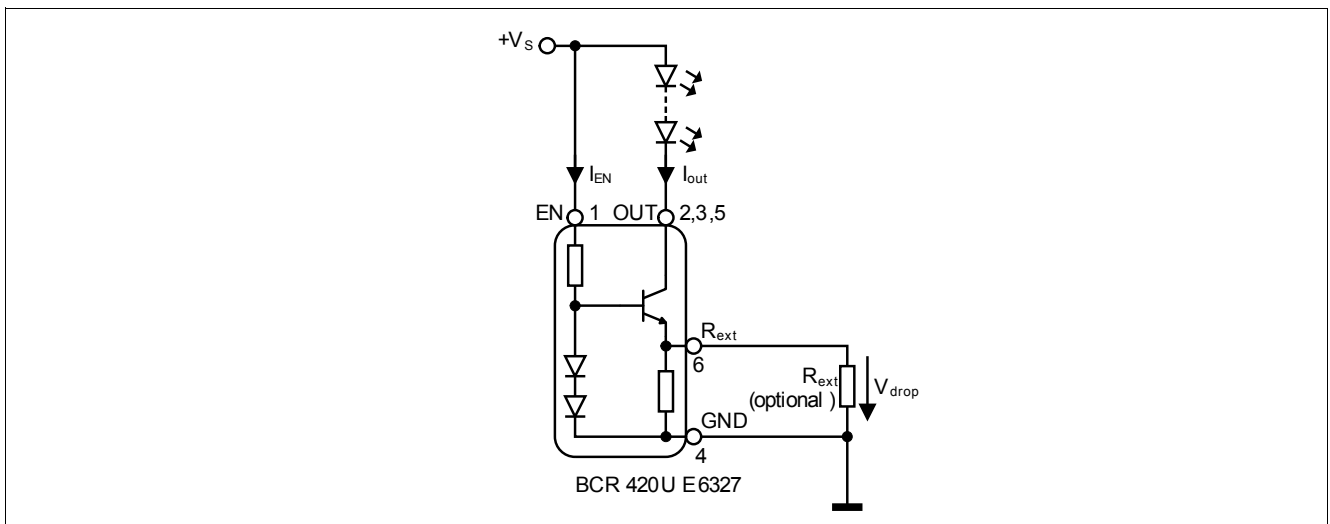

Figure 4-2 Application Circuit: Enabling by Connecting to V_S

Application hints

BCR 420U E6327 / BCR 421U E6327 serve as an easy to use constant current sources for LEDs. In stand alone application an external resistor can be connected to adjust the current from 10 mA to 250 mA. R_{ext} can be determined by using [Figure 3-5](#) or [Figure 3-15](#). Connecting a low tolerance resistor R_{ext} will improve the overall accuracy of the current sense resistance formed by the parallel connection of R_{int} and R_{ext} leading to an improved current accuracy. Please take into account that the resulting output currents will be slightly lower due to the self heating of the component and the negative thermal coefficient.

Please visit our web site www.infineon.com/lowcostleddriver for application notes and for up-to-date application information.

5 Package

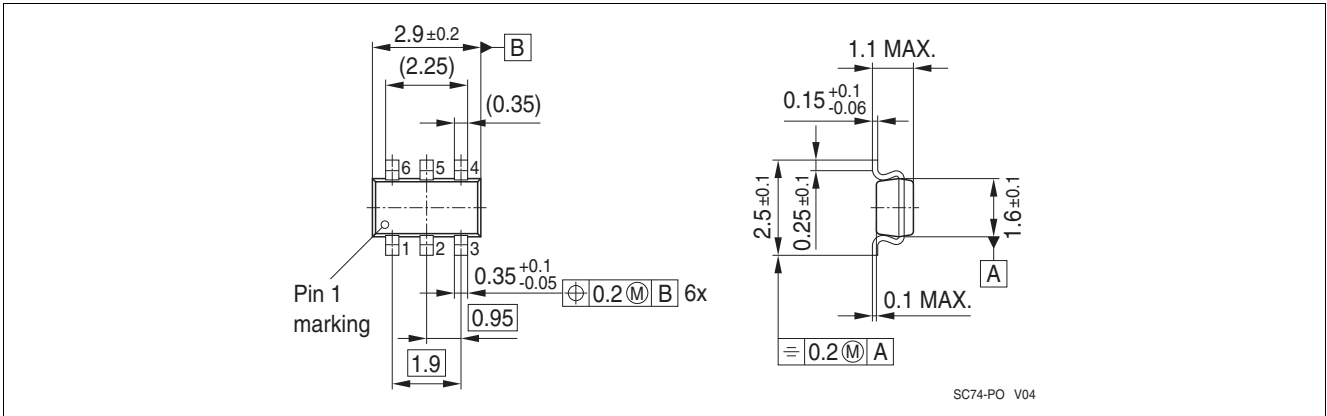

Figure 5-1 Package Outline for SC74 (dimensions in mm)

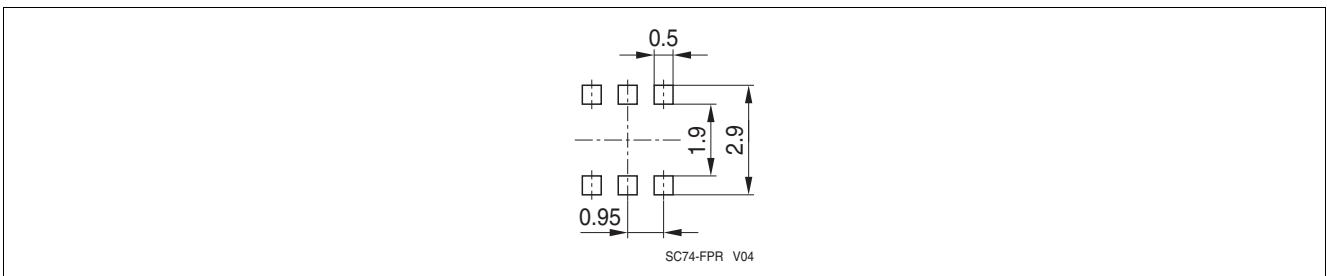

Figure 5-2 Package Footprint for SC74 (dimensions in mm)

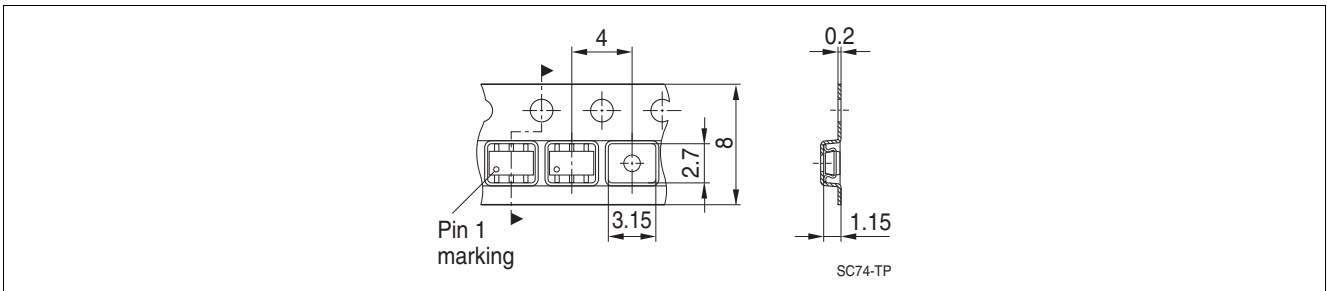

Figure 5-3 Tape and Reel Information for SC74 (dimensions in mm)

Terminology

$\Delta I_{out}/I_{out}$	Output current change
h_{FE}	DC current gain
I_{EN}	Enable current
I_{out}	Output current
I_R	Reverse current
LED	Light Emitting Diode
PCB	Printed Circuit Board
P_{tot}	Total power dissipation
PWM	Pulse Width Modulation
R_B	Bias resistor
R_{ext}	External resistor
R_{int}	Internal resistor
RoHS	Restriction of Hazardous Substance directive
R_{thJS}	Thermal resistance junction to soldering point
T_A	Ambient temperature
T_J	Junction temperature
T_S	Soldering point temperature
T_{stg}	Storage temperature
$V_{BR(CEO)}$	Collector-emitter breakdown voltage
V_{BR}	Breakdown voltage
V_{drop}	Voltage drop
V_{EN}	Enable voltage
V_{out}	Output voltage
V_R	Reverse voltage
V_S	Supply voltage
V_{Smin}	Lowest sufficient supply voltage overhead

www.infineon.com

Published by Infineon Technologies AG

Downloaded From [Oneyac.com](https://www.oneyac.com)

单击下面可查看定价，库存，交付和生命周期等信息

[>>Infineon Technologies\(英飞凌\)](#)