Schnelle Diode
Fast Diode
D690S
Elektrische Eigenschaften / Electrical properties

Höchstzulässige Werte / Maximum rated values

Periodische Spitzensperrspannung repetitive peak reverse voltages	$T_{vj} = -25^{\circ}\text{C} \dots T_{vj \text{ max}}$	V_{RRM}	2000 2200	2400 2600	V V
Durchlaßstrom-Grenzeffektivwert maximum RMS on-state current		I_{FRMSM}		1600	A
Dauergrenzstrom average on-state current	$T_C = 100^{\circ}\text{C}$	I_{FAVM}		690	A
Dauergrenzstrom average on-state current	$T_C = 55^{\circ}\text{C}, \theta = 180^{\circ}\text{sin}, t_P = 10 \text{ ms}$	I_{FAVM}		870	A
Durchlaßstrom-Effektivwert RMS on-state current		I_{FRMS}		1360	A
Stoßstrom-Grenzwert surge current	$T_{vj} = 25^{\circ}\text{C}, t_P = 10 \text{ ms}$ $T_{vj} = T_{vj \text{ max}}, t_P = 10 \text{ ms}$ $T_{vj} = 25^{\circ}\text{C}, t_P = 1 \text{ ms}$ $T_{vj} = T_{vj \text{ max}}, t_P = 1 \text{ ms}$	I_{FSM}		14000 11500 33400 27500	A A A A
Grenzlastintegral I^2t -value	$T_{vj} = 25^{\circ}\text{C}, t_P = 10 \text{ ms}$ $T_{vj} = T_{vj \text{ max}}, t_P = 10 \text{ ms}$ $T_{vj} = 25^{\circ}\text{C}, t_P = 1 \text{ ms}$ $T_{vj} = T_{vj \text{ max}}, t_P = 1 \text{ ms}$	I^2t		980 661 558 378	$10^3 \text{ A}^2\text{s}$ $10^3 \text{ A}^2\text{s}$ $10^3 \text{ A}^2\text{s}$ $10^3 \text{ A}^2\text{s}$

Charakteristische Werte / Characteristic values

Durchlaßspannung on-state voltage	$T_{vj} = T_{vj \text{ max}}, i_F = 3000\text{A}$	V_F	max.	2,7	V
Schleusenspannung threshold voltage	$T_{vj} = T_{vj \text{ max}}$	$V_{(TO)}$		1,0	V
Ersatzwiderstand slope resistance	$T_{vj} = T_{vj \text{ max}}$	r_T		0,5	m Ω
Durchlaßkennlinie 200 A $\leq i_F \leq$ 3000 A on-state characteristic $v_F = A + B \cdot i_F + C \cdot \ln(i_F + 1) + D \cdot \sqrt{i_F}$	$T_{vj} = T_{vj \text{ max}}$	A= B= C= D=		-1,575E-01 6,000E-04 2,421E-01 -1,582E-02	
Spitzenwert der Durchlaßverzögerungsspannung peak value of forward recovery voltage	DIN IEC 747-2 $T_{vj} = T_{vj \text{ max}}, di_F/dt = 50\text{A}/\mu\text{s}, v_R = 0\text{V}$	V_{FRM}	typ.	16,5	V
Durchlaßverzögerungszeit forward recovery time	DIN IEC 747-2, Methode / Method II $T_{vj} = T_{vj \text{ max}}, i_{FM} = 3000\text{A}$ $di_F/dt = 50\text{A}/\mu\text{s}, v_R = 0\text{V}$	t_{fr}	typ.	6,2	μs
Sperrstrom reverse current	$T_{vj} = 25^{\circ}\text{C}, v_R = V_{RRM}$ $T_{vj} = T_{vj \text{ max}}, v_R = V_{RRM}$	i_R	max. max.	25 250	mA mA
Rückstromspitze peak reverse recovery current	DIN IEC 747-2, $T_{vj} = T_{vj \text{ max}}$ $i_{FM} = 1020\text{A}, -di_F/dt = 50\text{A}/\mu\text{s}$ $v_R \leq 0,5V_{RRM}, v_{RM} = 0,8V_{RRM}$	I_{RM}		155	A
Sperrverzögerungsladung recovered charge	DIN IEC 747-2, $T_{vj} = T_{vj \text{ max}}$ $i_{FM} = 1020\text{A}, -di_F/dt = 50\text{A}/\mu\text{s}$ $v_R \leq 0,5V_{RRM}, v_{RM} = 0,8V_{RRM}$	Q_r		970	μAs
Sperrverzögerungszeit reverse recovery time	DIN IEC 747-2, $T_{vj} = T_{vj \text{ max}}$ $i_{FM} = 1020\text{A}, -di_F/dt = 50\text{A}/\mu\text{s}$ $v_R \leq 0,5V_{RRM}, v_{RM} = 0,8V_{RRM}$	t_{rr}		9	μs

prepared by:	H.Sandmann	date of publication:	2008-09-15
approved by:	M.Leifeld	revision:	3.0

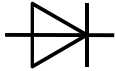
Schnelle Diode
Fast Diode
D690S
Thermische Eigenschaften / Thermal properties

Innerer Wärmewiderstand thermal resistance, junction to case	Kühlfläche / cooling surface beidseitig / two sided, $\Theta = 180^\circ \text{ sin}$ beidseitig / two sided, DC Anode / anode, $\Theta = 180^\circ \text{ sin}$ Anode / anode, DC Kathode / cathode, $\Theta = 180^\circ \text{ sin}$ Kathode / cathode, DC	R_{thJC}	max. 0,039 °C/W max. 0,036 °C/W max. 0,063 °C/W max. 0,060 °C/W max. 0,930 °C/W max. 0,900 °C/W
Übergangs-Wärmewiderstand thermal resistance, case to heatsink	Kühlfläche / cooling surface beidseitig / two-sided einseitig / single-sided	R_{thCH}	max. 0,005 °C/W max. 0,010 °C/W
Höchstzulässige Sperrschichttemperatur maximum junction temperature		$T_{\text{vj max}}$	150 °C
Betriebstemperatur operating temperature		$T_{\text{c op}}$	-40...+150 °C
Lagertemperatur storage temperature		T_{stg}	-40...+150 °C

Mechanische Eigenschaften / Mechanical properties

Gehäuse, siehe Anlage case, see annex			Seite 3 page 3
Si-Element mit Druckkontakt Si-pellet with pressure contact			
Anpreßkraft clamping force		F	10...24 kN
Gewicht weight		G	typ. 300 g
Kriechstrecke creepage distance			25 mm
Schwingfestigkeit vibration resistance	f = 50 Hz		50 m/s ²

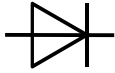
S

Datenblatt / Data sheet

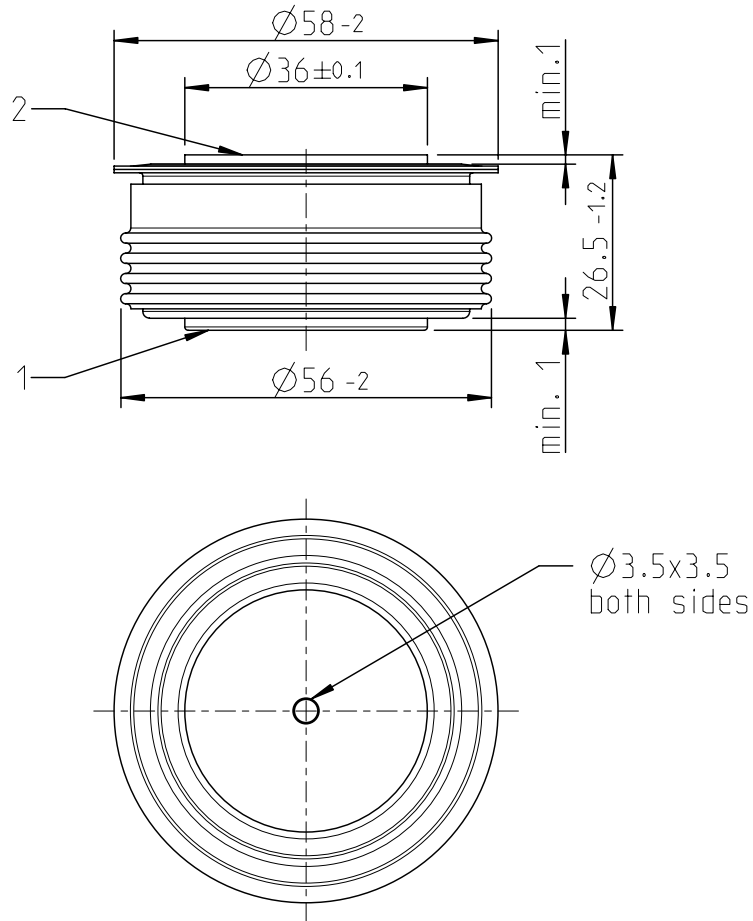
Schnelle Diode
Fast Diode**D690S**

strike distance: 20mm
creepage distance: 25mm

overall height based
on contact pressure

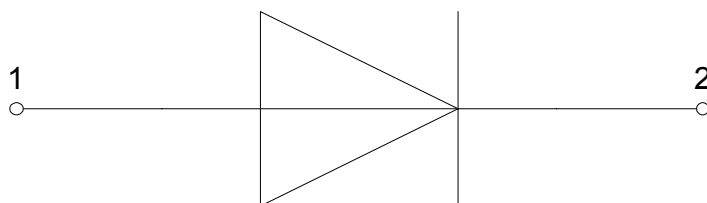
**1: Anode/Anode****2: Kathode/Cathode**

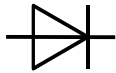
Schnelle Diode
Fast Diode

D690S

Analytische Elemente des transienten Wärmewiderstandes Z_{thJC} für DC
Analytical elements of transient thermal impedance Z_{thJC} for DC

Kühlung / Cooling	Pos. n	1	2	3	4	5	6	7
beidseitig two-sided	R_{thn} [°C/W]	0,000044	0,00310	0,003256	0,015	0,01439	-	-
	τ_n [s]	0,000141	0,00238	0,023400	0,164	1,14000	-	-
anodenseitig anode-sided	R_{thn} [°C/W]	0,000052	0,003458	0,00658	0,0156	0,03431	-	-
	τ_n [s]	0,000161	0,002470	0,04330	0,2610	6,29000	-	-
kathodenseitig cathode-sided	R_{thn} [°C/W]	0,000048	0,00340	0,004162	0,0145	0,0153	0,05259	-
	τ_n [s]	0,000151	0,00243	0,031500	0,1700	4,5600	8,86000	-

Analytische Funktion / Analytical function:

$$Z_{thJC} = \sum_{n=1}^{n_{max}} R_{thn} \left(1 - e^{-\frac{t}{\tau_n}} \right)$$

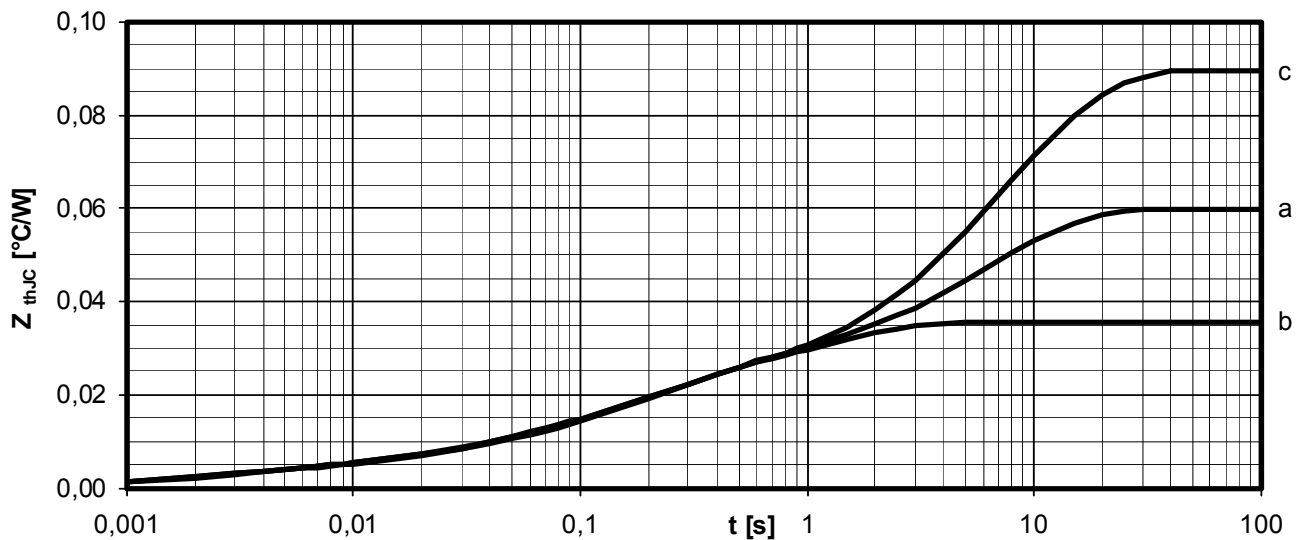
Transienter innerer Wärmewiderstand für DC / Transient thermal impedance for DC

$$Z_{thJC} = f(t)$$

- a - Anodenseitige Kühlung / Anode-sided cooling
- b - Beidseitige Kühlung / Two-sided cooling
- c - Kathodenseitige Kühlung / Cathode-sided cooling

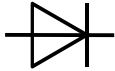
Schnelle Diode
Fast Diode

D690S

Erhöhung des $Z_{th DC}$ bei sinus- und rechteckförmigen Strömen für unterschiedliche Stromflusswinkel Θ
 Rise of $Z_{th DC}$ for sinewave and rectangular current for different current conduction angles Θ

$$\Delta Z_{th \Theta rec} / \Delta Z_{th \Theta sin}$$

Kühlung / Cooling		$\Theta = 180^\circ$	$\Theta = 120^\circ$	$\Theta = 90^\circ$	$\Theta = 60^\circ$	$\Theta = 30^\circ$
beidseitig two-sided	$\Delta Z_{th \Theta rec}$ [°C/W]	0,00426	0,00738	0,00981	0,01328	0,01852
	$\Delta Z_{th \Theta sin}$ [°C/W]	0,00280	0,00428	0,00637	0,00978	0,01569
anodenseitig anode-sided	$\Delta Z_{th \Theta rec}$ [°C/W]	0,00447	0,00779	0,01038	0,01406	0,01958
	$\Delta Z_{th \Theta sin}$ [°C/W]	0,00293	0,00451	0,00674	0,01035	0,01658
kathodenseitig cathode-sided	$\Delta Z_{th \Theta rec}$ [°C/W]	0,00447	0,00773	0,01036	0,01405	0,01960
	$\Delta Z_{th \Theta sin}$ [°C/W]	0,00292	0,00448	0,00672	0,01033	0,01660

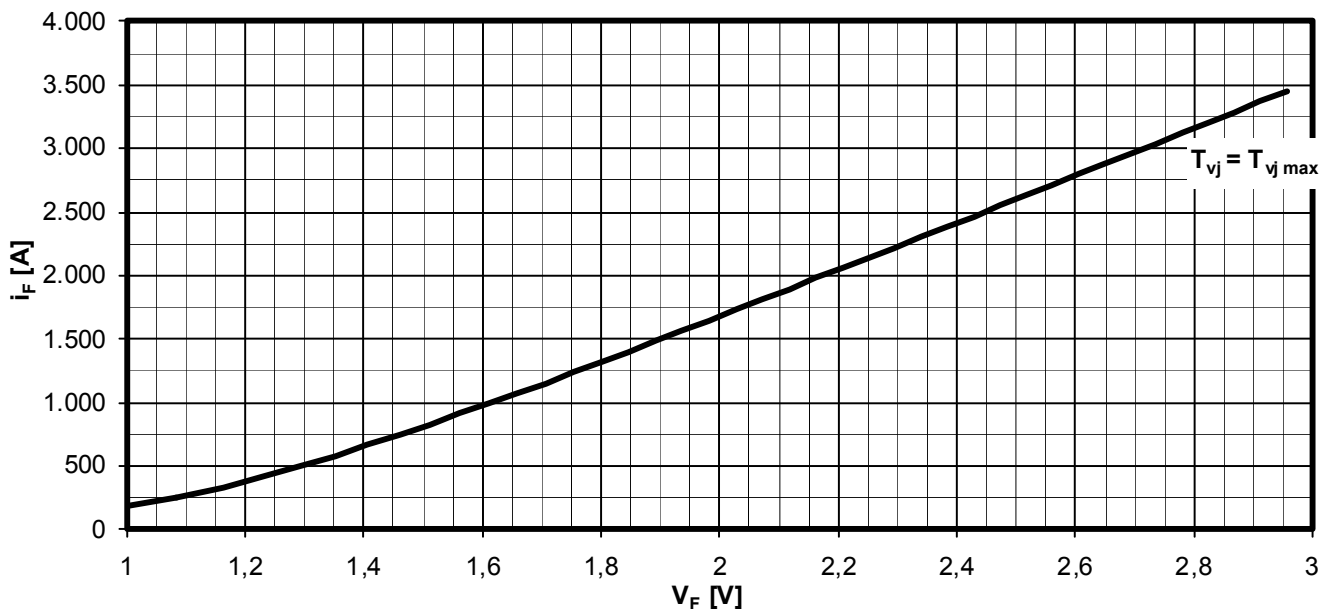

$$Z_{th \Theta rec} = Z_{th DC} + \Delta Z_{th \Theta rec}$$

$$Z_{th \Theta sin} = Z_{th DC} + \Delta Z_{th \Theta sin}$$

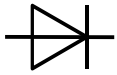

Grenzdurchlasskennlinie / Limiting on-state characteristic $i_F = f(V_F)$

$$T_{vj} = T_{vj max}$$

S		Datenblatt / Data sheet		
Schnelle Diode Fast Diode		D690S		
<p>Nutzungsbedingungen</p> <p>Die in diesem Produktdatenblatt enthaltenen Daten sind ausschließlich für technisch geschultes Fachpersonal bestimmt. Die Beurteilung der Geeignetheit dieses Produktes für die von Ihnen anvisierte Anwendung sowie die Beurteilung der Vollständigkeit der bereitgestellten Produktdaten für diese Anwendung obliegt Ihnen bzw. Ihren technischen Abteilungen.</p> <p>In diesem Produktdatenblatt werden diejenigen Merkmale beschrieben, für die wir eine liefervertragliche Gewährleistung übernehmen. Eine solche Gewährleistung richtet sich ausschließlich nach Maßgabe der im jeweiligen Liefervertrag enthaltenen Bestimmungen. Garantien jeglicher Art werden für das Produkt und dessen Eigenschaften keinesfalls übernommen.</p> <p>Sollten Sie von uns Produktinformationen benötigen, die über den Inhalt dieses Produktdatenblatts hinausgehen und insbesondere eine spezifische Verwendung und den Einsatz dieses Produktes betreffen, setzen Sie sich bitte mit dem für Sie zuständigen Vertriebsbüro in Verbindung (siehe www.infineon.com). Für Interessenten halten wir Application Notes bereit.</p> <p>Aufgrund der technischen Anforderungen könnte unser Produkt gesundheitsgefährdende Substanzen enthalten. Bei Rückfragen zu den in diesem Produkt jeweils enthaltenen Substanzen setzen Sie sich bitte ebenfalls mit dem für Sie zuständigen Vertriebsbüro in Verbindung.</p> <p>Sollten Sie beabsichtigen, das Produkt in Anwendungen der Luftfahrt, in gesundheits- oder lebensgefährdenden oder lebenserhaltenden Anwendungsbereichen einzusetzen, bitten wir um Mitteilung. Wir weisen darauf hin, dass wir für diese Fälle</p> <ul style="list-style-type: none"> - die gemeinsame Durchführung eines Risiko- und Qualitätsassessments; - den Abschluss von speziellen Qualitätssicherungsvereinbarungen; - die gemeinsame Einführung von Maßnahmen zu einer laufenden Produktbeobachtung dringend empfehlen und gegebenenfalls die Belieferung von der Umsetzung solcher Maßnahmen abhängig machen. <p>Soweit erforderlich, bitten wir Sie, entsprechende Hinweise an Ihre Kunden zu geben.</p> <p>Inhaltliche Änderungen dieses Produktdatenblatts bleiben vorbehalten.</p> <p>Terms & Conditions of usage</p> <p>The data contained in this product data sheet is exclusively intended for technically trained staff. You and your technical departments will have to evaluate the suitability of the product for the intended application and the completeness of the product data with respect to such application.</p> <p>This product data sheet is describing the characteristics of this product for which a warranty is granted. Any such warranty is granted exclusively pursuant the terms and conditions of the supply agreement. There will be no guarantee of any kind for the product and its characteristics.</p> <p>Should you require product information in excess of the data given in this product data sheet or which concerns the specific application of our product, please contact the sales office, which is responsible for you (see www.infineon.com). For those that are specifically interested we may provide application notes.</p> <p>Due to technical requirements our product may contain dangerous substances. For information on the types in question please contact the sales office, which is responsible for you.</p> <p>Should you intend to use the Product in aviation applications, in health or live endangering or life support applications, please notify. Please note, that for any such applications we urgently recommend</p> <ul style="list-style-type: none"> - to perform joint Risk and Quality Assessments; - the conclusion of Quality Agreements; - to establish joint measures of an ongoing product survey, and that we may make delivery depended on the realization of any such measures. <p>If and to the extent necessary, please forward equivalent notices to your customers.</p> <p>Changes of this product data sheet are reserved.</p>				
IFBIP D AEC / 2008-09-15, H.Sandmann		A 48/08	Seite/page	6/6

单击下面可查看定价，库存，交付和生命周期等信息

[>>Infineon Technologies\(英飞凌\)](#)