

100mΩ Power Distribution Switches

General Description

The RT9701 is an integrated 100mΩ power switch for self-powered and bus-powered Universal Series Bus (USB) applications. A built-in charge pump is used to drive the N-Channel MOSFET that is free of parasitic body diode to eliminate any reversed current flow across the switch when it is powered off. Its low quiescent current (23μA) and small package (SOT-23-5) is particularly suitable in battery-powered portable equipment.

Several protection functions include soft start to limit inrush current during plug-in, current limiting at 1.5A to meet USB power requirement, and thermal shutdown to protect damage under over current conditions.

Ordering Information

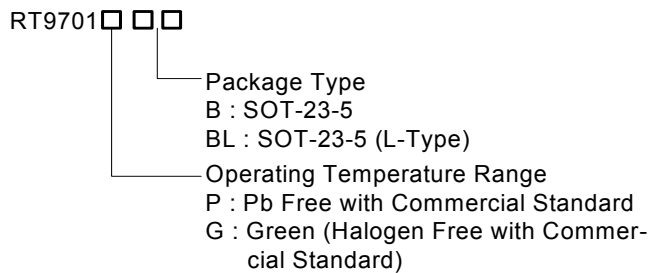

Note :

RichTek Pb-free and Green products are :

- ▶RoHS compliant and compatible with the current requirements of IPC/JEDEC J-STD-020.
- ▶Suitable for use in SnPb or Pb-free soldering processes.
- ▶100% matte tin (Sn) plating.

Marking Information

For marking information, contact our sales representative directly or through a RichTek distributor located in your area, otherwise visit our website for detail.

Features

- 100mΩ Typ. High-Side NMOSFET (SOT-23-5)
- Guaranteed 1.1A Continuous Current
- 1.5A Current Limit
- Small SOT-23-5 Package Minimizes Board Space
- Soft Start
- Thermal Protection
- Low 23μA Supply Current
- Wide Input Voltage Range : 2.2V to 6V
- UL Approved - #E219878
- RoHS Compliant and 100% Lead (Pb)-Free

Applications

- Battery-Powered Equipment
- Motherboard USB Power Switch
- USB Device Power Switch
- Hot-Plug Power Supplies
- Battery-Charger Circuits

Pin Configurations

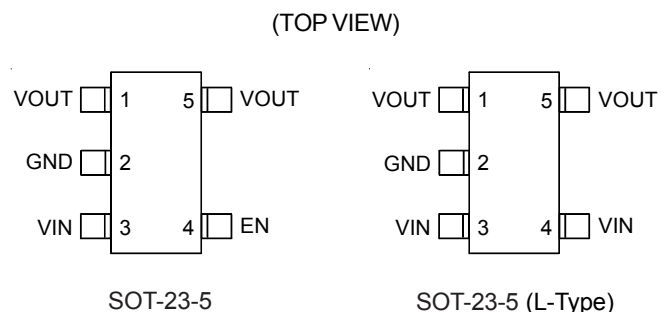

Typical Application Circuit

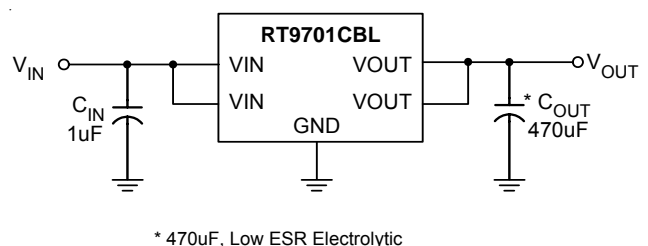

Test Circuits

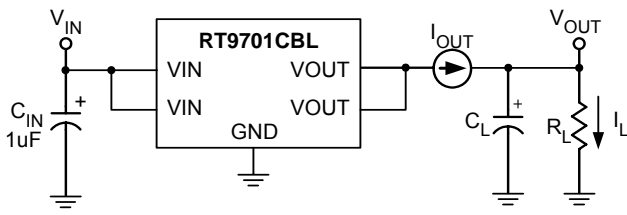

Test Circuit 1

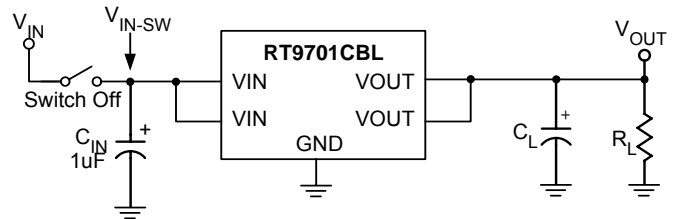

Test Circuit 2

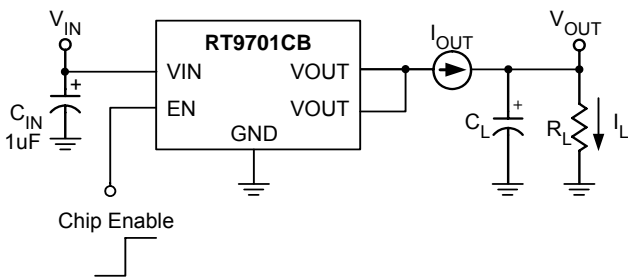

Test Circuit 3

Test Circuit 2 is performed by charging an external tank of bulk capacitor to the input then applying this voltage to the input of the unit.

All typical operating characteristics curves showed are referred to Test Circuit 1, unless specified to Test Circuit 2 or Test Circuit 3.

Functional Pin Description

Pin Name	Pin Function
VIN	Power Input Voltage
VOUT	Output Voltage
GND	Ground
EN	Chip Enable (Active High)

Function Block Diagram

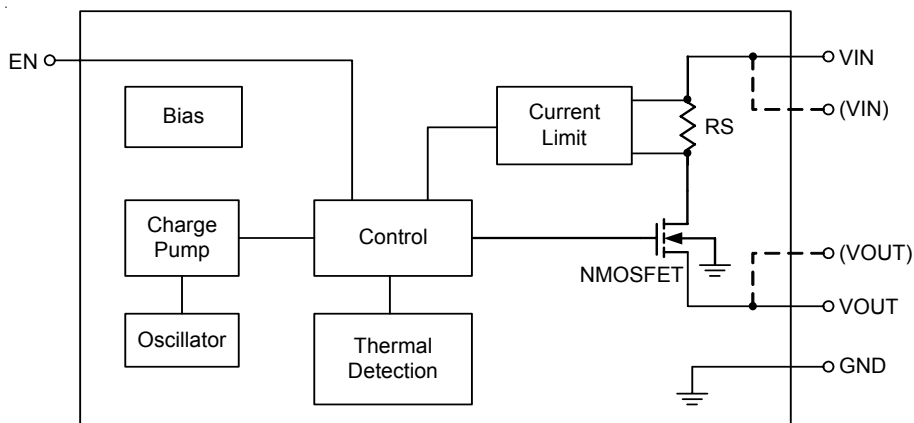

Absolute Maximum Ratings

- Supply Voltage ----- 7V
- Chip Enable ----- -0.3V to 7V
- Power Dissipation, $P_D @ T_A = 25^\circ\text{C}$
 SOT-23-5 ----- 0.25W
- Package Thermal Resistance
 SOT-23-5, θ_{JA} ----- $250^\circ\text{C} / \text{W}$
- Lead Temperature (Soldering, 10 sec.) ----- 260°C
- Operating Junction Temperature Range ----- -20°C to 100°C
- Storage Temperature Range ----- -65°C to 150°C
- V_{OUT} ESD Level
 HBM (Human Body Mode) ----- 8kV
 MM (Machine Mode) ----- 800V

Electrical Characteristics

($V_{IN} = 5\text{V}$, $C_{IN} = C_{OUT} = 1\mu\text{F}$, $T_A = 25^\circ\text{C}$, unless otherwise specified)

Parameter	Symbol	Test Conditions	Min	Typ	Max	Units
Input Voltage Range	V_{IN}		2.2	--	6	V
Output NMOSFET $R_{DS(ON)}$	RT9701CBL	$I_L = 1\text{A}$	--	85	100	m Ω
	RT9701CB	$I_L = 1\text{A}$	--	87	100	
Quiescent Current		$V_{IN} = 3\text{V}$	--	19	40	μA
		$V_{IN} = 5\text{V}$	--	23	45	
Output Turn-On Rising Time	T_R	$R_L = 10\Omega$, 90% Settling	--	400	--	μs
Current Limit Threshold	I_{LIMIT}	$R_L = 2\Omega$	1.1	1.5	2	A
Short-circuit Fold Back Current	I_{OS}	$V_{OUT} = 0\text{V}$, measured prior to thermal shutdown	--	1.0	--	A
EN Input High Threshold	RT9701CB		2.0	--	--	V
EN Input Low Threshold	RT9701CB		--	--	0.8	V
Shutdown Supply Current	RT9701CB	I_{OFF} EN = "0"	--	0.1	1	μA
Output Leakage Current	RT9701CB	$I_{LEAKAGE}$ EN = "0", $V_{OUT} = 0\text{V}$	--	0.5	10	μA
V_{IN} Under Voltage Lockout	UVLO		1.3	1.8	--	V
V_{IN} Under Voltage Hysteresis			--	100	--	mV
Thermal Limit	T_{SD}		--	130	--	$^\circ\text{C}$
Thermal Limit Hysteresis	ΔT_{SD}		--	20	--	$^\circ\text{C}$

Typical Operating Characteristics

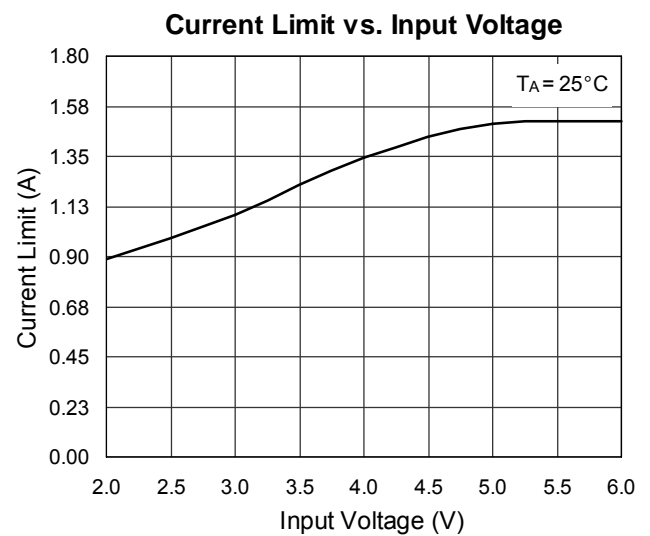
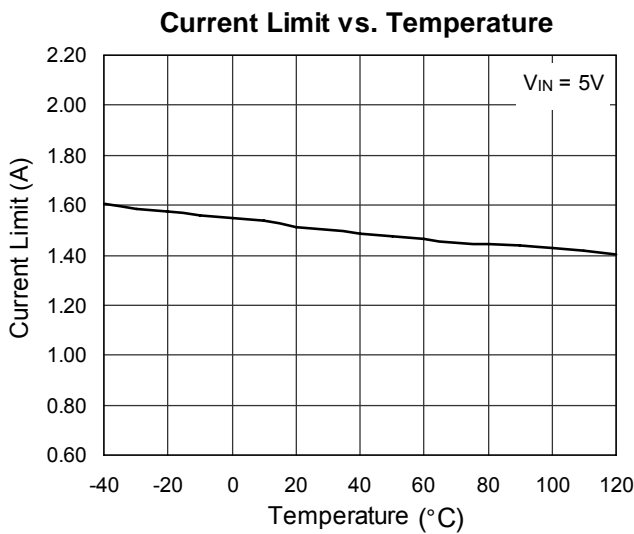
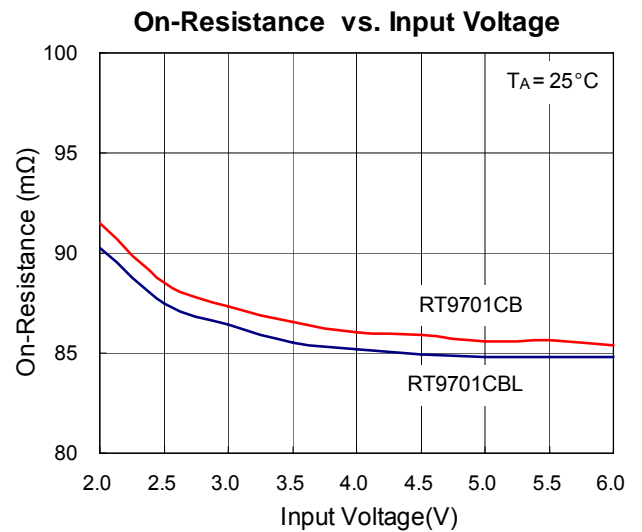
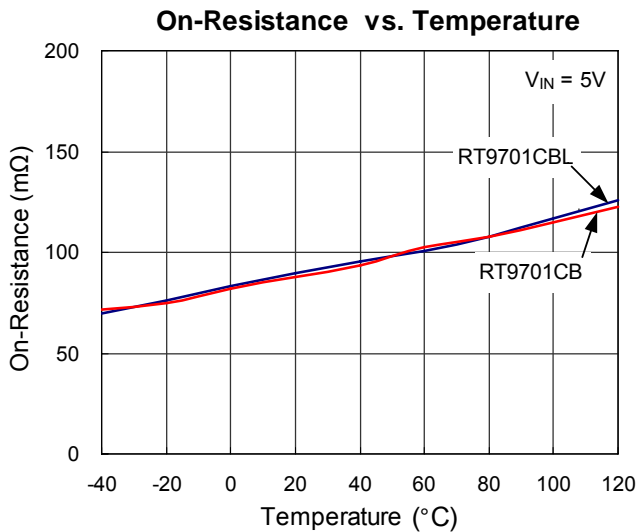
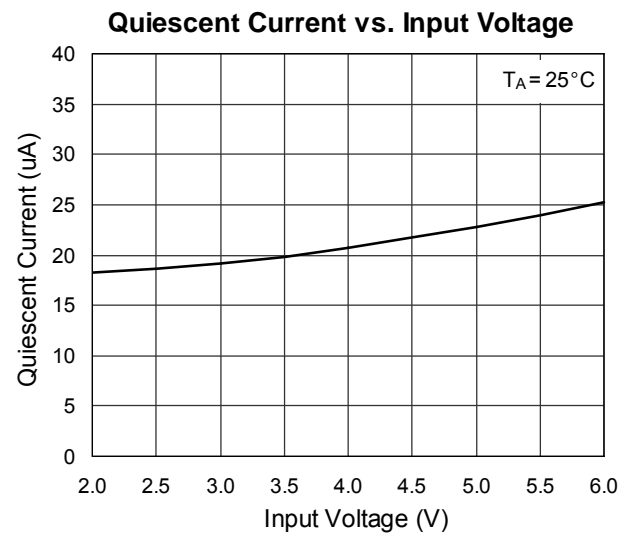
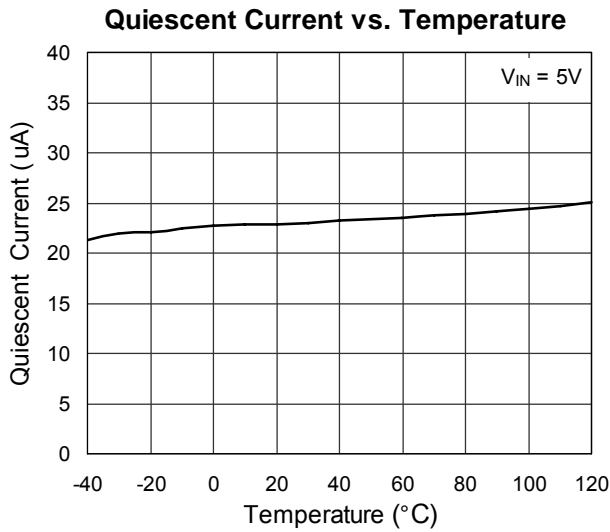

Short Circuit Current vs. Temperature

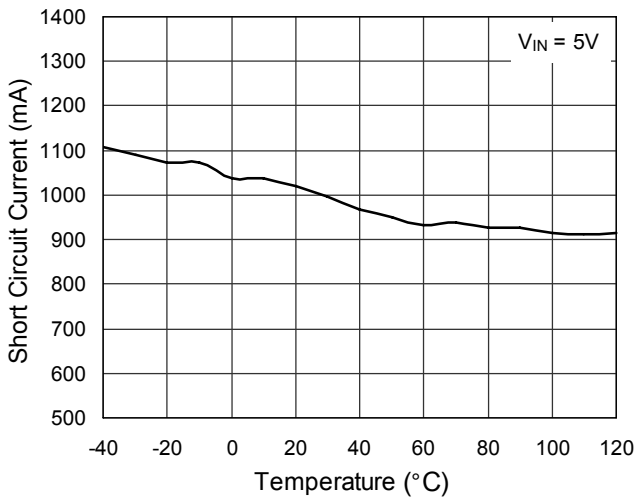

Short Circuit Current vs. Input Voltage

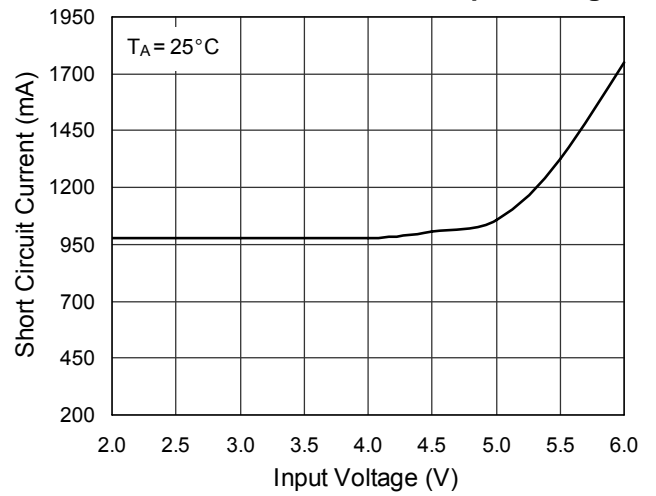

EN Pin Threshold Voltage vs.

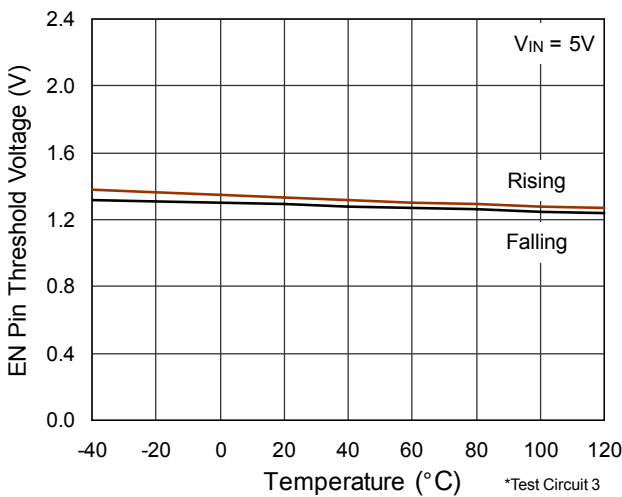

EN Pin Threshold Voltage vs. Input

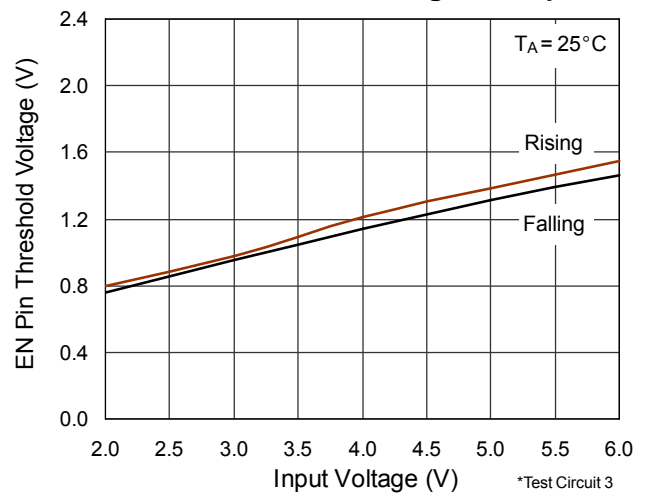

Turn On Rising Time vs. Temperature

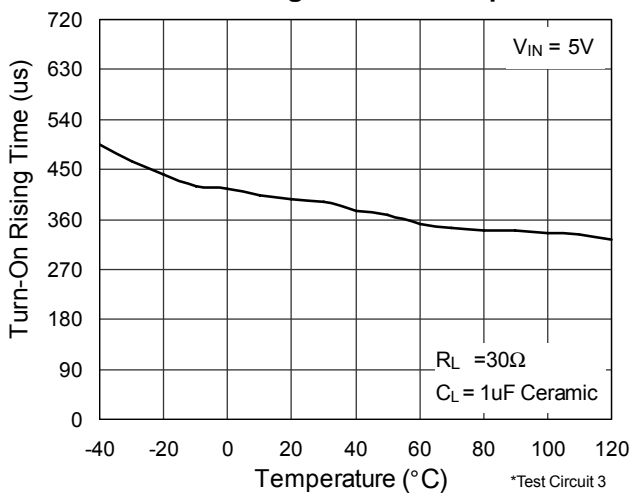

Turn Off Falling Time vs. Temperature

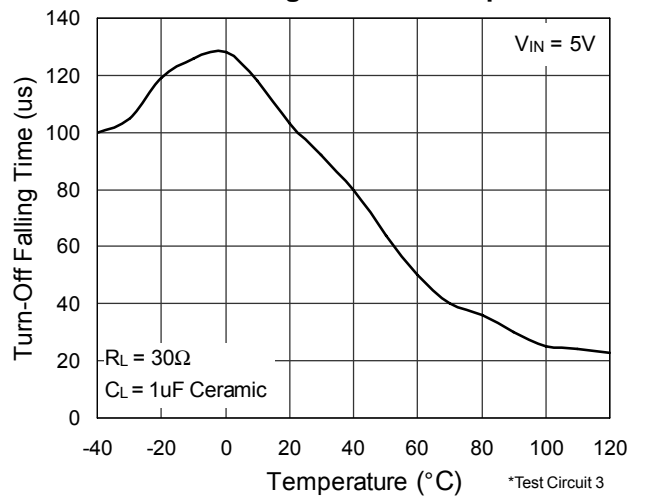

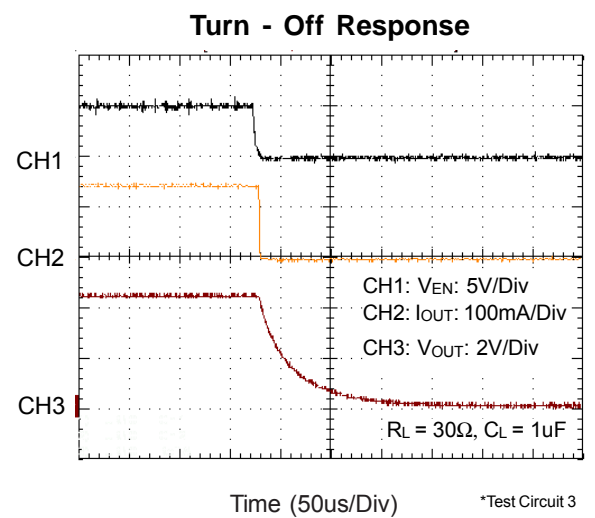
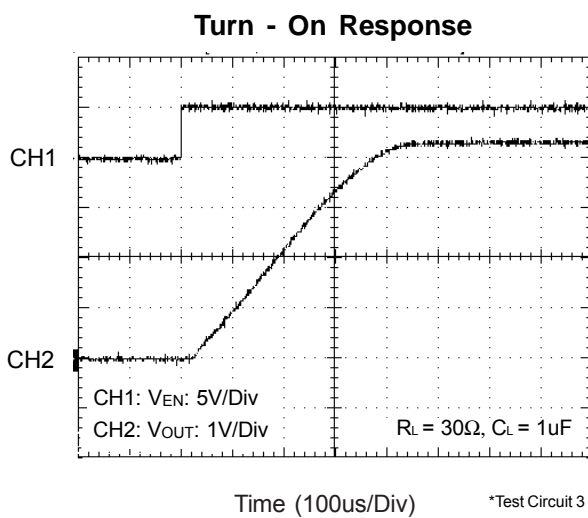
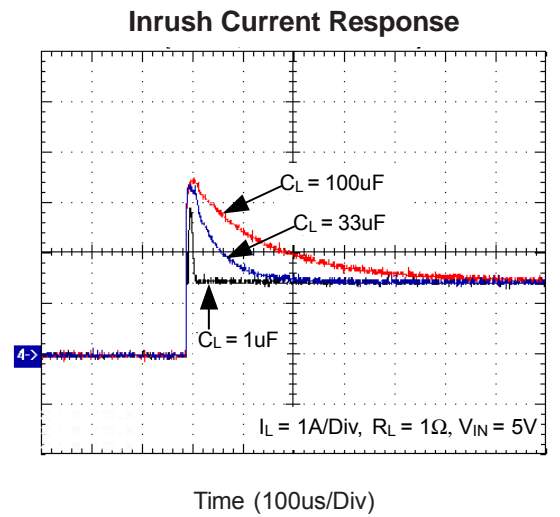
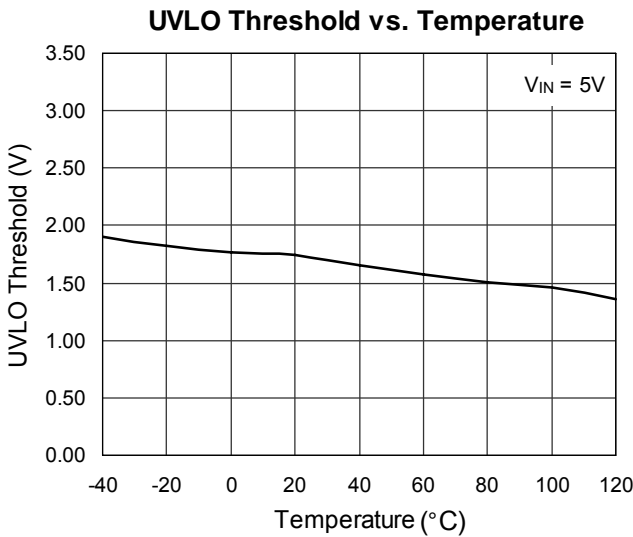
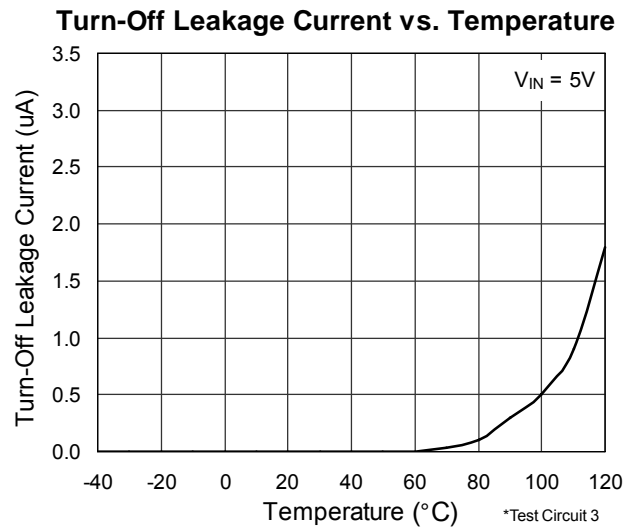
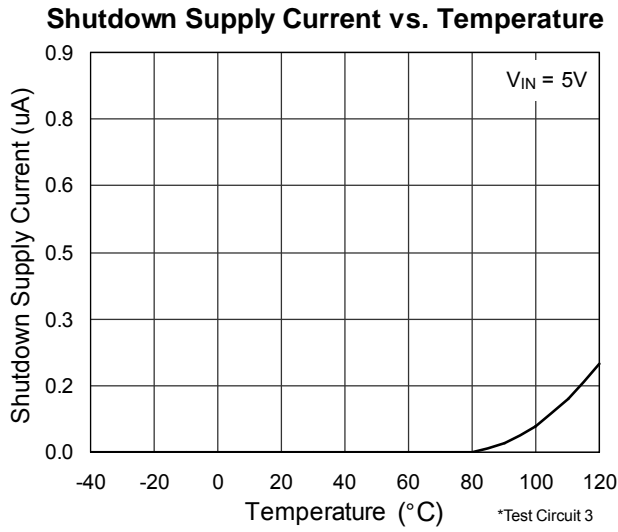

UVLO at Rising

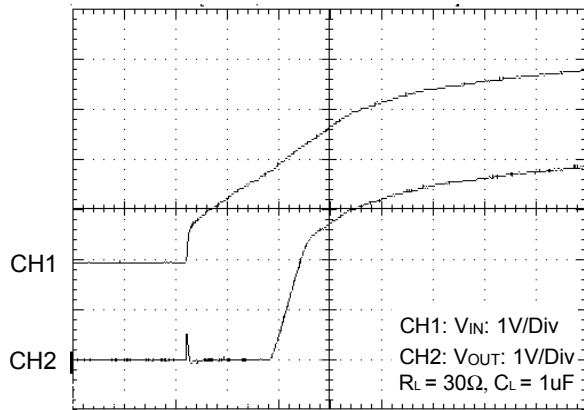

Time (500us/Div)

UVLO at Falling

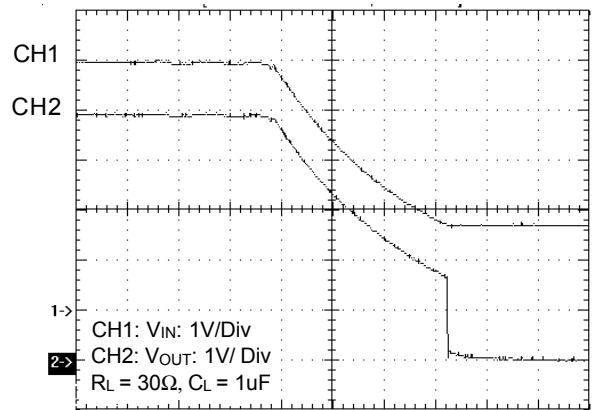

Time (100ms/Div)

*Test Circuit 2

Inrush Short Circuit Response

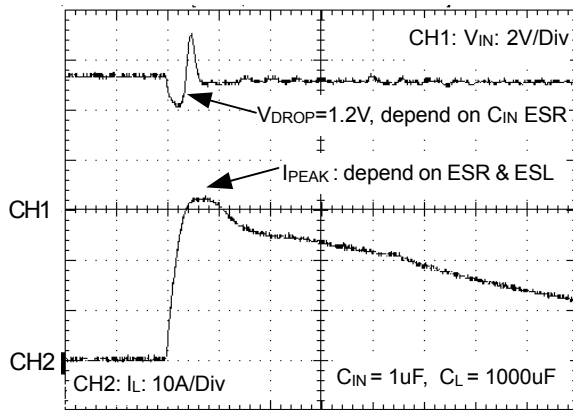

Time (25us/Div)

Soft - start Short Circuit Response

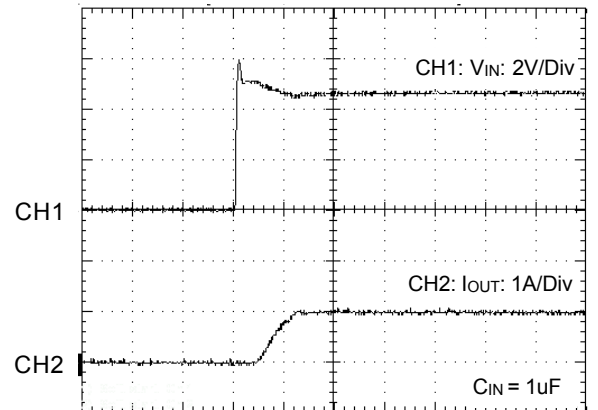

Time (5us/Div)

Ramped Load Response

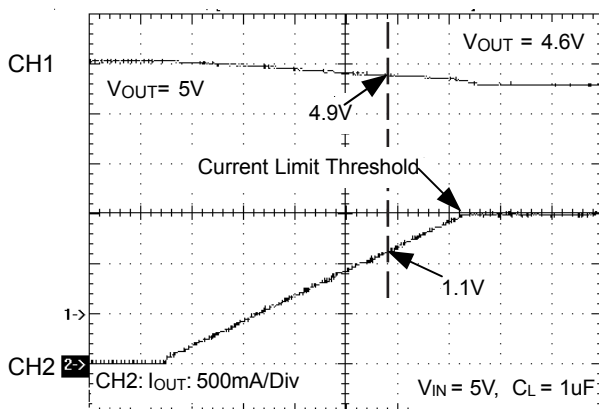

Time (1ms/Div)

Current Limit Response

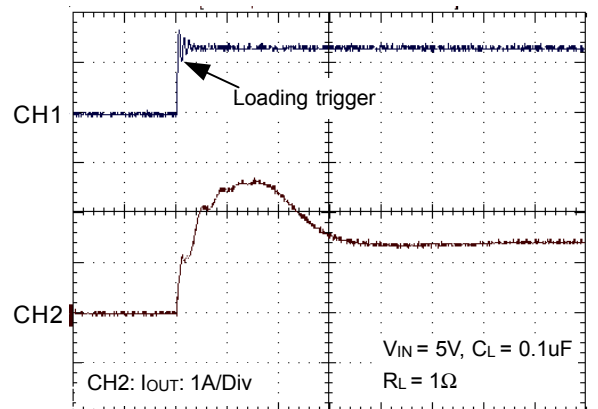

Time (5us/Div)

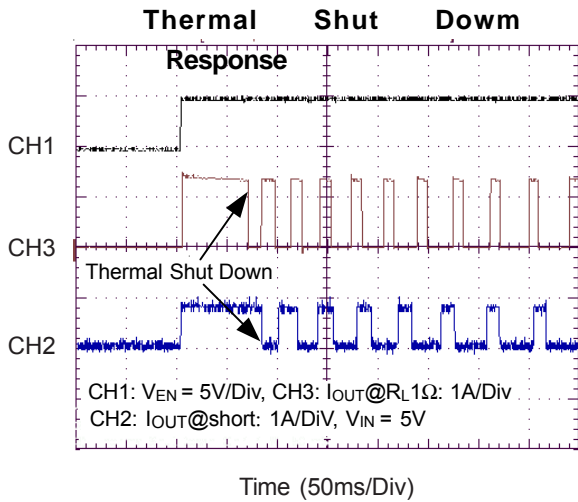

Application Information

The RT9701 is a high-side single N-Channel MOSFET switch with active-high enable input.

Input and Output

VIN (input) is the power supply connection to the circuitry and the drain of the output MOSFET. VOUT (output) is the source of the output MOSFET. In a typical circuit, current flows through the switch from VIN to VOUT toward the load. Both VOUT pins must be short on the board and connected to the load and so do both VIN pins but connected to the power source.

Thermal Shutdown

Thermal shutdown shuts off the output MOSFET if the die temperature exceeds 130°C and 20°C of hysteresis forces the switch turning off until the die temperature drops to 110°C.

Soft Start

In order to eliminate the upstream voltage droop caused by the large inrush current during hot-plug events, the “soft-start” feature effectively isolates power supplies from such highly capacitive loads.

Under-voltage Lockout

UVLO prevents the MOSFET switch from turning on until input voltage exceeds 1.8V (typical). If input voltage drops below 1.8V (typical), UVLO shuts off the MOSFET switch.

Current Limiting and Short Protection

The current limit circuit is designed to protect the system supply, the MOSFET switch and the load from damage caused by excessive currents. The current limit threshold is set internally to allow a minimum of 1.1A through the MOSFET but limits the output current to approximately 1.5A typical. When the output is short to ground, it will limit to a constant current 1A until thermal shutdown or short condition removed.

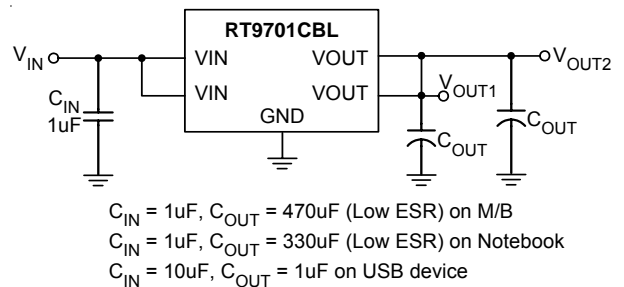

Figure 1. High Side Power Switch

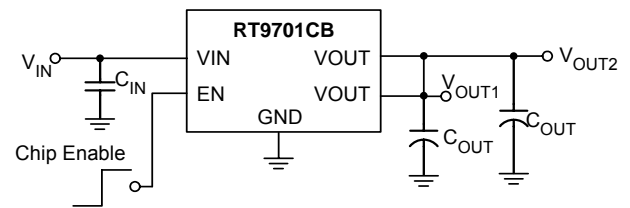

Figure 2. High Side Power Switch with Chip Enable Control

Filtering

To limit the input voltage drop during hot-plug events, connect a 1μF ceramic capacitor from VIN to GND. However, higher capacitor values will further reduce the voltage drop at the input.

Connect a sufficient capacitor from VOUT to GND. This capacitor helps to prevent inductive parasitics from pulling VOUT negative during turn-off or EMI damage to other components during the hot-detachment. It is also necessary for meeting the USB specification during hot plug-in operation. If RT9701 is implanted in device end application, minimum 1μF capacitor from VOUT to GND is recommended and higher capacitor values are also preferred.

In choosing these capacitors, special attention must be paid to the Effective Series Resistance, ESR, of the capacitors to minimize the IR drop across the capacitor ESR. A lower ESR on this capacitor can get a lower IR drop during the operation.

Ferrite beads in series with all power and ground lines are recommended to eliminate or significantly reduce EMI. In selecting a ferrite bead, the DC resistance of the wire used must be kept to a minimum to reduce the voltage drop.

Reverse current preventing

The output MOSFET and driver circuitry are also designed to allow the MOSFET source to be externally forced to a higher voltage than the drain ($V_{OUT} > V_{IN} \geq 0$). To prevent reverse current from such condition, disable the switch (RT9701CB) or connect VIN to a fixed voltage under 1.3V.

Layout and Thermal Dissipation

- Place the switch as close to the USB connector as possible. Keep all traces as short as possible to reduce the effect of undesirable parasitic inductance.
- Place the ot capacitor and ferrite beads asclose to the USB connector as possible.
- If ferrite beads are used, use wires with minimum resistance and large solder pads to minimize connection resistance.
- If the package is with dual VOUT or VIN pins, short both the same function pins as Figure 1 or Figure 2 to reduce the internal turn-on resistance. If the output power will be delivered to two individual ports, it is specially necessary to short both VOUT pin at the switch output side in order to protect the switch when each port are plug-in separately.
- Under normal operating conditions, the package can dissipate the channel heat away. Wide power-bus planes connected to VIN and VOUT and a ground plane in contact with the device will help dissipate additional heat.

Outline Dimension

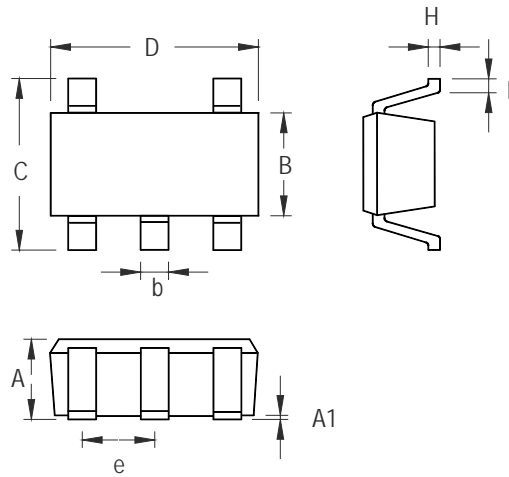

Symbol	Dimensions In Millimeters		Dimensions In Inches	
	Min	Max	Min	Max
A	0.889	1.295	0.035	0.051
A1	0.000	0.152	0.000	0.006
B	1.397	1.803	0.055	0.071
b	0.356	0.559	0.014	0.022
C	2.591	2.997	0.102	0.118
D	2.692	3.099	0.106	0.122
e	0.838	1.041	0.033	0.041
H	0.080	0.254	0.003	0.010
L	0.300	0.610	0.012	0.024

SOT-23-5 Surface Mount Package

Richtek Technology Corporation

Headquarter
 5F, No. 20, Taiyuen Street, Chupei City
 Hsinchu, Taiwan, R.O.C.
 Tel: (8863)5526789 Fax: (8863)5526611

Richtek Technology Corporation

Taipei Office (Marketing)
 8F, No. 137, Lane 235, Paochiao Road, Hsintien City
 Taipei County, Taiwan, R.O.C.
 Tel: (8862)89191466 Fax: (8862)89191465
 Email: marketing@richtek.com

单击下面可查看定价，库存，交付和生命周期等信息

[>>Richtek\(台湾立锜\)](#)