

# International IR Rectifier

INSULATED GATE BIPOLAR TRANSISTOR WITH  
HYPERFAST DIODE

PD - 95970A

## IRG4BC30FD-SPbF

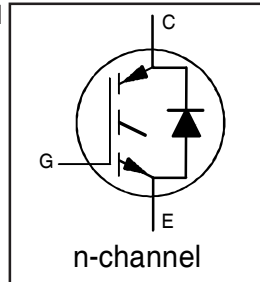
Fast CoPack IGBT

### Features

- Fast: optimized for medium operating frequencies (1-5 kHz in hard switching, >20kHz in resonant mode).
- Generation 4 IGBT design provides tighter parameter distribution and higher efficiency than Generation 3.
- IGBT co-packaged with HEXFRED™ ultrafast, ultra-soft recovery anti-parallel diodes for use in bridge configurations.
- Lead-Free

### Benefits

- Generation 4 IGBT's offer highest efficiency available.
- IGBT's optimized for specific application conditions.
- HEXFRED diodes optimized for performance with IGBT's. Minimized recovery characteristics require less/no snubbing.
- Designed to be a "drop-in" replacement for equivalent industry-standard Generation 3 IR IGBT's.



|                                   |
|-----------------------------------|
| $V_{CES} = 600V$                  |
| $V_{CE(on)} \text{ typ.} = 1.59V$ |
| @ $V_{GE} = 15V, I_C = 17A$       |



### Absolute Maximum Ratings

|                           | Parameter                                 | Max.        | Units      |
|---------------------------|---|-------------|------------|
| $V_{CES}$                 | Collector-to-Emitter Voltage              | 600         | V          |
| $I_C @ T_C = 25^\circ C$  | Continuous Collector Current              | 31          | A          |
| $I_C @ T_C = 100^\circ C$ | Continuous Collector Current              | 17          |            |
| $I_{CM}$                  | Pulse Collector Current (Ref.Fig.C.T.5) ① | 124         |            |
| $I_{LM}$                  | Clamped Inductive Load current ②          | 124         |            |
| $I_F @ T_C = 100^\circ C$ | Diode Continuous Forward Current          | 12          |            |
| $I_{FM}$                  | Diode Maximum Forward Current             | 120         |            |
| $V_{GE}$                  | Gate-to-Emitter Voltage                   | $\pm 20$    | V          |
| $P_D @ T_C = 25^\circ C$  | Maximum Power Dissipation                 | 100         | W          |
| $P_D @ T_C = 100^\circ C$ | Maximum Power Dissipation                 | 42          |            |
| $T_J$                     | Operating Junction and                    | -55 to +150 | $^\circ C$ |
| $T_{STG}$                 | Storage Temperature Range                 |             |            |

### Thermal / Mechanical Characteristics

|                 | Parameter   | Min. | Typ.       | Max. | Units        |
|-----------------|---|------|------------|------|--------------|
| $R_{\theta JC}$ | Junction-to-Case- IGBT                            | —    | —          | 1.2  | $^\circ C/W$ |
| $R_{\theta CS}$ | Case-to-Sink, flat, greased surface               | —    | 0.50       | —    |              |
| $R_{\theta JA}$ | Junction-to-Ambient (PCB Mounted, steady state) ③ | —    | —          | 40   |              |
| Wt              | Weight  | —    | 2.0 (0.07) | —    | g (oz.)      |

# IRG4BC30FD-SPbF

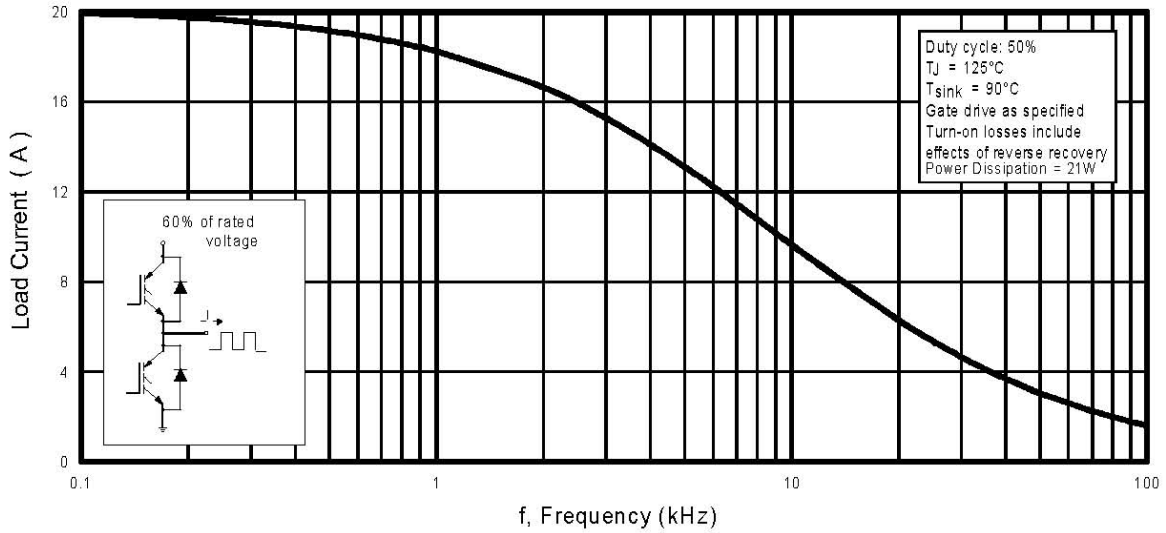
International  
IOR Rectifier

## Electrical Characteristics @ T<sub>J</sub> = 25°C (unless otherwise specified)

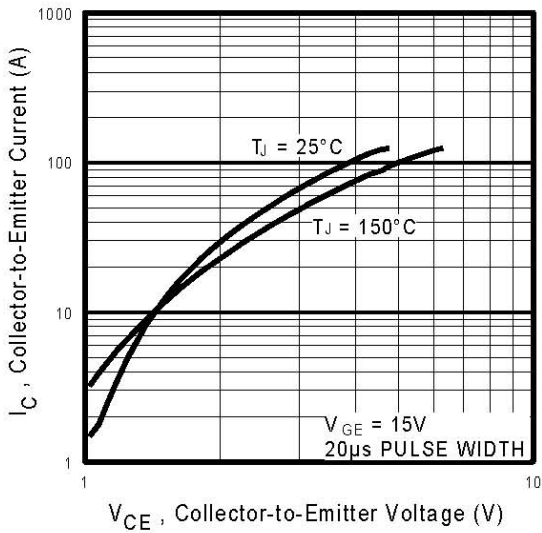
|  | Parameter                                | Min. | Typ. | Max. | Units | Conditions   |  |
|--|--|------|------|------|-------|--|--|
| V <sub>(BR)CES</sub>                   | Collector-to-Emitter Breakdown Voltage ③ | 600  | —    | —    | V     | V <sub>GE</sub> = 0V, I <sub>C</sub> = 250μA   |  |
| ΔV <sub>(BR)CES</sub> /ΔT <sub>J</sub> | Temperature Coeff. of Breakdown Voltage  | —    | 0.69 | —    | V/°C  | V <sub>GE</sub> = 0V, I <sub>C</sub> = 1mA   |  |
| V <sub>CE(on)</sub>                    | Collector-to-Emitter Voltage             | —    | 1.59 | 1.8  | V     | I <sub>C</sub> = 17A<br>I <sub>C</sub> = 31A<br>I <sub>C</sub> = 17A, T <sub>J</sub> = 150°C |  |
|  |  | —    | 1.99 | —    |       |  | V <sub>GE</sub> = 15V<br>See Fig. 2, 5 |
|  |  | —    | 1.7  | —    |       |  |  |
| V <sub>GE(th)</sub>                    | Gate Threshold Voltage                   | 3.0  | —    | 6.0  | V     | V <sub>CE</sub> = V <sub>GE</sub> , I <sub>C</sub> = 250μA                                   |  |
| ΔV <sub>GE(th)</sub> /ΔT <sub>J</sub>  | Threshold Voltage temp. coefficient      | —    | -11  | —    | mV/°C | V <sub>CE</sub> = V <sub>GE</sub> , I <sub>C</sub> = 250μA                                   |  |
| g <sub>fe</sub>                        | Forward Transconductance ④               | 6.1  | 10   | —    | S     | V <sub>CE</sub> = 100V, I <sub>C</sub> = 17A   |  |
| I <sub>CES</sub>                       | Zero Gate Voltage Collector Current      | —    | —    | 250  | μA    | V <sub>GE</sub> = 0V, V <sub>CE</sub> = 600V   |  |
|  |  | —    | —    | 2500 |       | V <sub>GE</sub> = 0V, V <sub>CE</sub> = 600V, T <sub>J</sub> = 150°C                         |  |
| V <sub>FM</sub>                        | Diode Forward Voltage Drop               | —    | 1.4  | 1.7  | V     | I <sub>F</sub> = 12A<br>See Fig. 13  |  |
|  |  | —    | 1.3  | 1.6  |       | I <sub>F</sub> = 12A, T <sub>J</sub> = 150°C   |  |
| I <sub>GES</sub>                       | Gate-to-Emitter Leakage Current          | —    | —    | ±100 | nA    | V <sub>GE</sub> = ±20V   |  |

## Switching Characteristics @ T<sub>J</sub> = 25°C (unless otherwise specified)

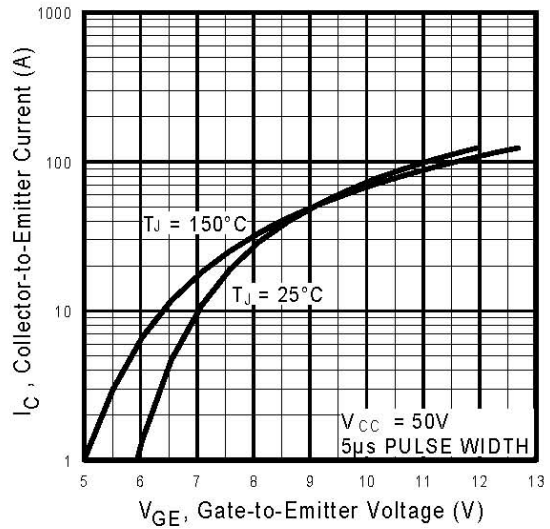
|                          | Parameter   | Min. | Typ. | Max. | Units | Conditions  |
|--------------------------|---|------|------|------|-------|---|
| Q <sub>g</sub>           | Total Gate Charge (turn-on)                               | —    | 51   | 77   | nC    | I <sub>C</sub> = 17A<br>V <sub>CC</sub> = 400V<br>V <sub>GE</sub> = 15V<br>See Fig. 8   |
| Q <sub>ge</sub>          | Gate-to-Emitter Charge (turn-on)                          | —    | 7.9  | 12   |       |   |
| Q <sub>gc</sub>          | Gate-to-Collector Charge (turn-on)                        | —    | 19   | 28   |       |   |
| t <sub>d(on)</sub>       | Turn-On delay time  | —    | 42   | —    | ns    | T <sub>J</sub> = 25°C<br>I <sub>C</sub> = 17A, V <sub>CC</sub> = 480V<br>V <sub>GE</sub> = 15V, R <sub>G</sub> = 23Ω<br>Energy losses include "tail" and diode reverse recovery.  |
| t <sub>r</sub>           | Rise time   | —    | 26   | —    |       |   |
| t <sub>d(off)</sub>      | Turn-Off delay time                                       | —    | 230  | 350  |       |   |
| t <sub>f</sub>           | Fall time   | —    | 160  | 230  |       |   |
| E <sub>on</sub>          | Turn-On Switching Loss                                    | —    | 0.63 | —    | mJ    | See Fig. 9, 10, 11, 18  |
| E <sub>off</sub>         | Turn-Off Switching Loss                                   | —    | 1.39 | —    |       |   |
| E <sub>ts</sub>          | Total Switching Loss                                      | —    | 2.02 | 3.9  |       |   |
| t <sub>d(on)</sub>       | Turn-On delay time  | —    | 42   | —    | ns    | T <sub>J</sub> = 150°C<br>I <sub>C</sub> = 17A, V <sub>CC</sub> = 480V<br>V <sub>GE</sub> = 15V, R <sub>G</sub> = 23Ω<br>Energy losses include "tail" and diode reverse recovery. |
| t <sub>r</sub>           | Rise time   | —    | 27   | —    |       |   |
| t <sub>d(off)</sub>      | Turn-Off delay time                                       | —    | 310  | —    |       |   |
| t <sub>f</sub>           | Fall time   | —    | 310  | —    |       |   |
| E <sub>ts</sub>          | Total Switching Loss                                      | —    | 3.2  | —    | mJ    | See Fig. 9,10,11,18   |
| L <sub>E</sub>           | Internal Emitter Inductance                               | —    | 7.5  | —    | nH    | Measured 5mm from package   |
| C <sub>ies</sub>         | Input Capacitance   | —    | 1100 | —    | pF    | V <sub>GE</sub> = 0V<br>V <sub>CC</sub> = 30V<br>f = 1.0MHz<br>See Fig. 7   |
| C <sub>oes</sub>         | Output Capacitance  | —    | 74   | —    |       |   |
| C <sub>res</sub>         | Reverse Transfer Capacitance                              | —    | 14   | —    |       |   |
| t <sub>rr</sub>          | Diode Reverse Recovery Time                               | —    | 42   | 60   | ns    | T <sub>J</sub> = 25°C<br>See Fig. 14  |
|                          |   | —    | 80   | 120  |       | T <sub>J</sub> = 125°C  |
| I <sub>rr</sub>          | Diode Peak Reverse Recovery Current                       | —    | 3.5  | 6.0  | A     | T <sub>J</sub> = 25°C<br>See Fig. 15  |
|                          |   | —    | 5.6  | 10   |       | T <sub>J</sub> = 125°C  |
| Q <sub>rr</sub>          | Diode Reverse Recovery Charge                             | —    | 80   | 180  | nC    | T <sub>J</sub> = 25°C<br>See Fig. 16  |
|                          |   | —    | 220  | 600  |       | T <sub>J</sub> = 125°C  |
| di <sub>(rec)M</sub> /dt | Diode Peak Rate of Fall of Recovery During t <sub>b</sub> | —    | 180  | —    | A/μs  | T <sub>J</sub> = 25°C<br>See Fig. 17  |
|                          |   | —    | 120  | —    |       | T <sub>J</sub> = 125°C  |



**Fig. 1** - Typical Load Current vs. Frequency  
 (Load Current =  $I_{RMS}$  of fundamental)



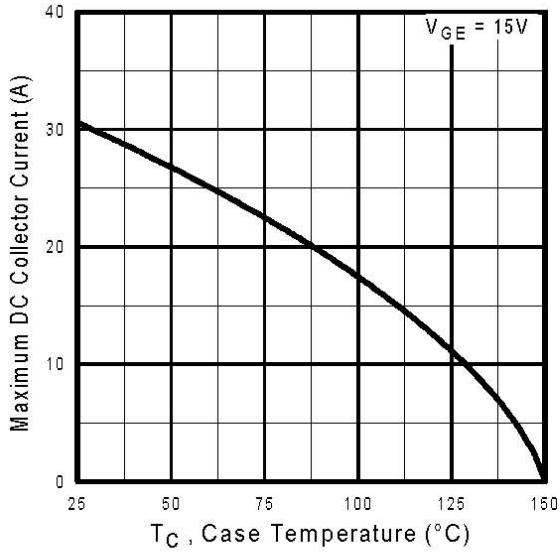
**Fig. 2** - Typical Output Characteristics



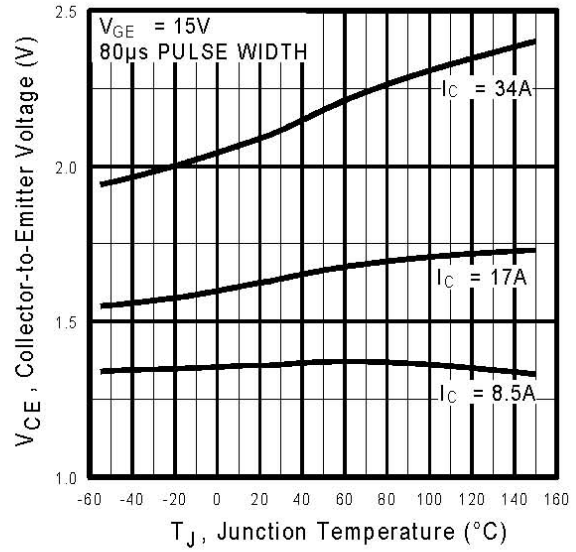
**Fig. 3** - Typical Transfer Characteristics

# IRG4BC30FD-SPbF

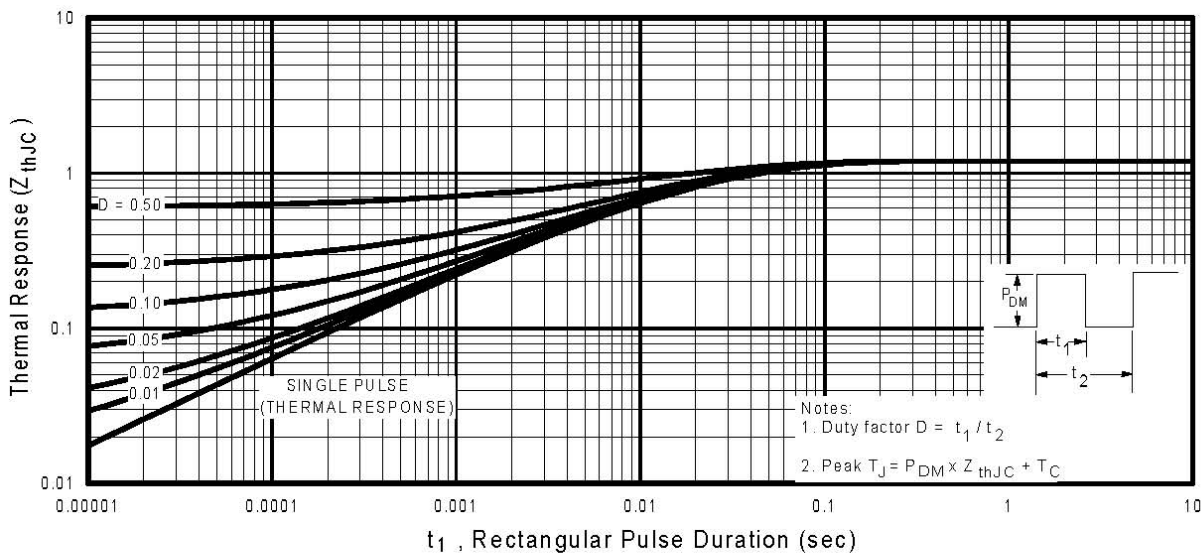
International  
**IR** Rectifier



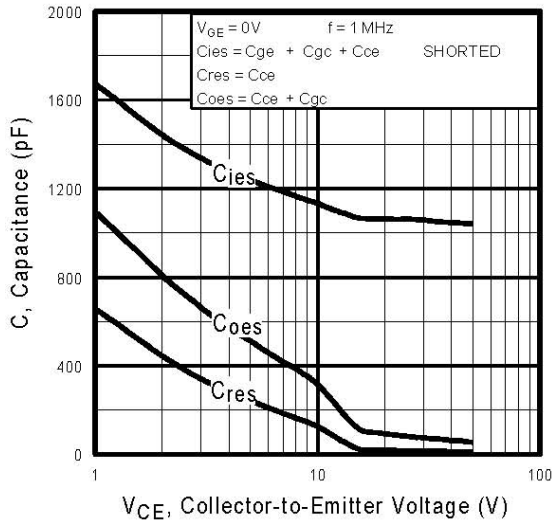
**Fig. 4 -** Maximum Collector Current vs. Case Temperature



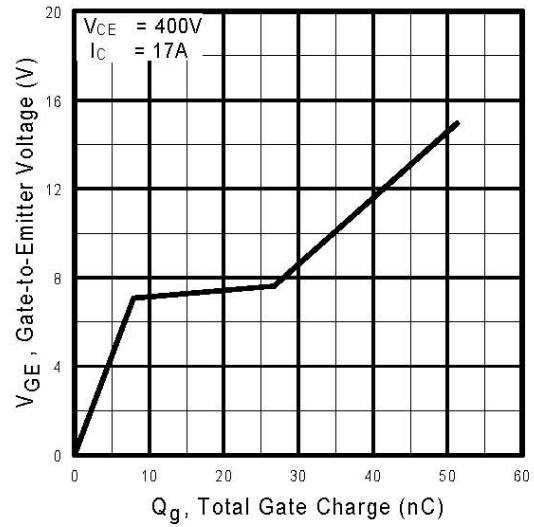
**Fig. 5 -** Typical Collector-to-Emitter Voltage vs. Junction Temperature



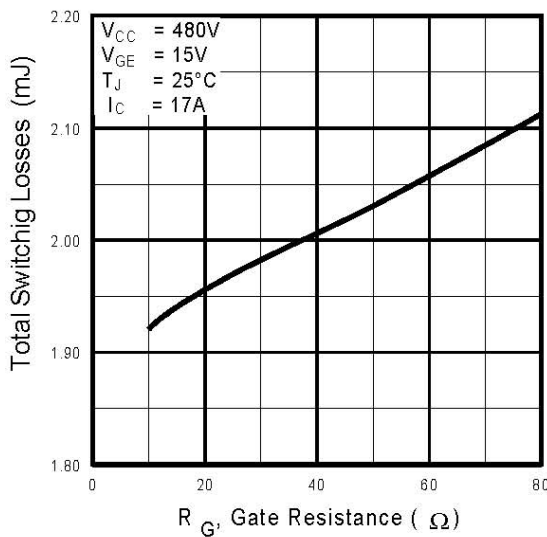
**Fig. 6 -** Maximum Effective Transient Thermal Impedance, Junction-to-Case



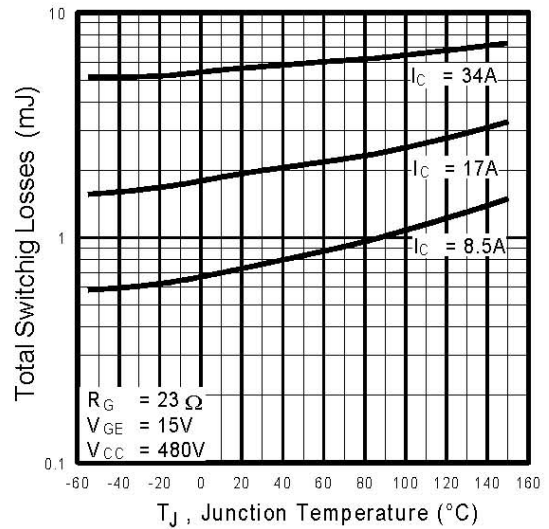
**Fig. 7** - Typical Capacitance vs. Collector-to-Emitter Voltage



**Fig. 8** - Typical Gate Charge vs. Gate-to-Emitter Voltage

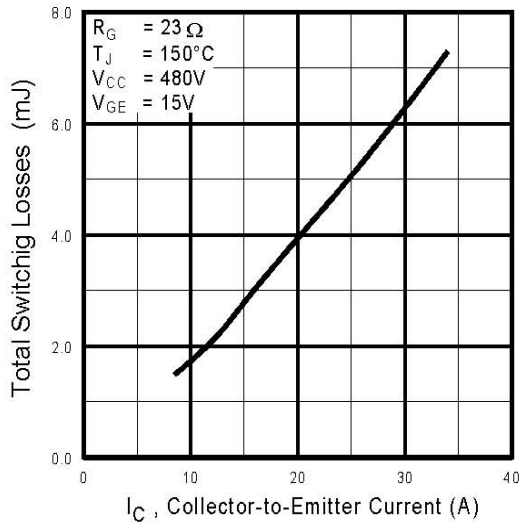


**Fig. 9** - Typical Switching Losses vs. Gate Resistance

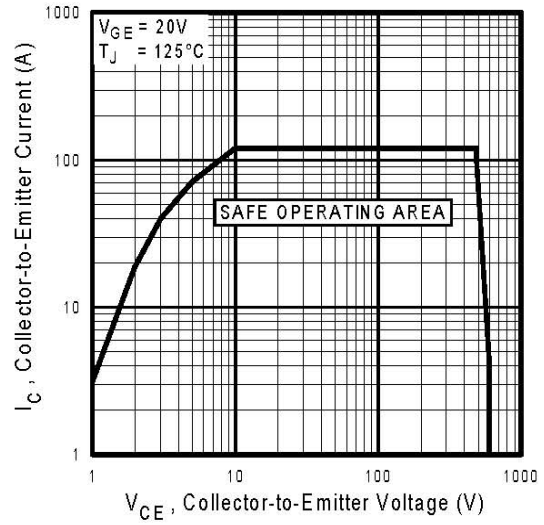


**Fig. 10** - Typical Switching Losses vs. Junction Temperature

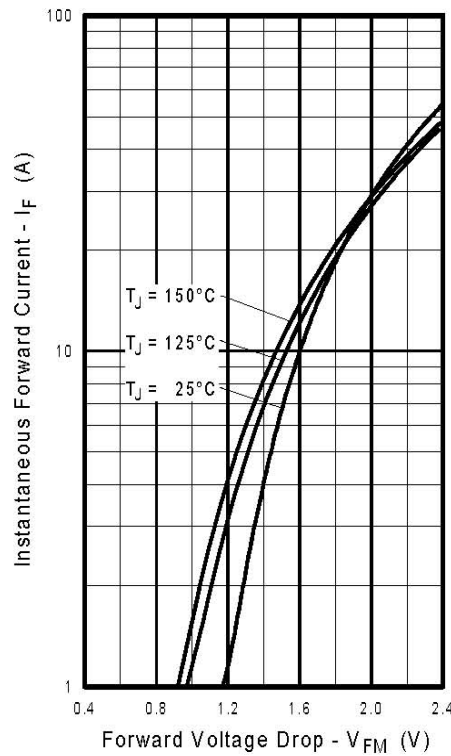
# IRG4BC30FD-SPbF



**Fig. 11** - Typical Switching Losses vs. Collector-to-Emitter Current



**Fig. 12** - Turn-Off SOA



**Fig. 13** - Maximum Forward Voltage Drop vs. Instantaneous Forward Current

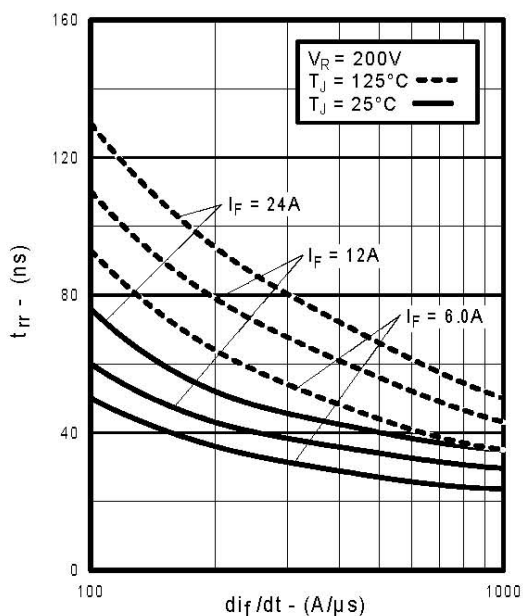


Fig. 14 - Typical Reverse Recovery vs.  $di_f/dt$

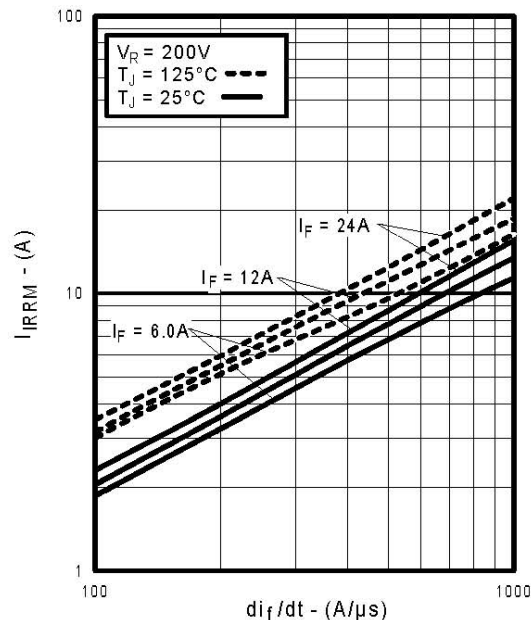


Fig. 15 - Typical Recovery Current vs.  $di_f/dt$

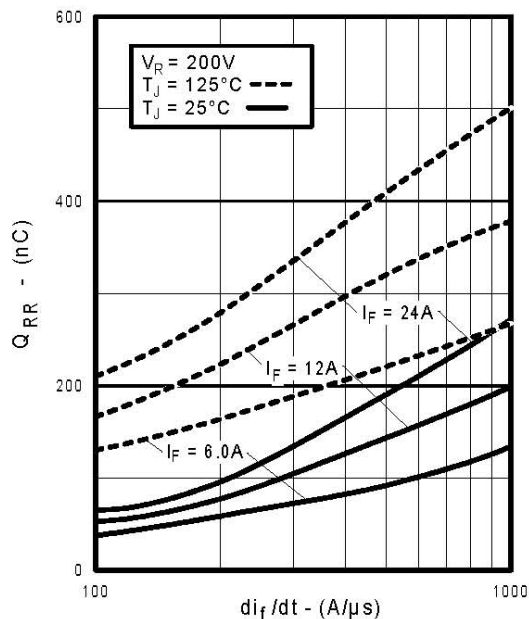


Fig. 16 - Typical Stored Charge vs.  $di_f/dt$

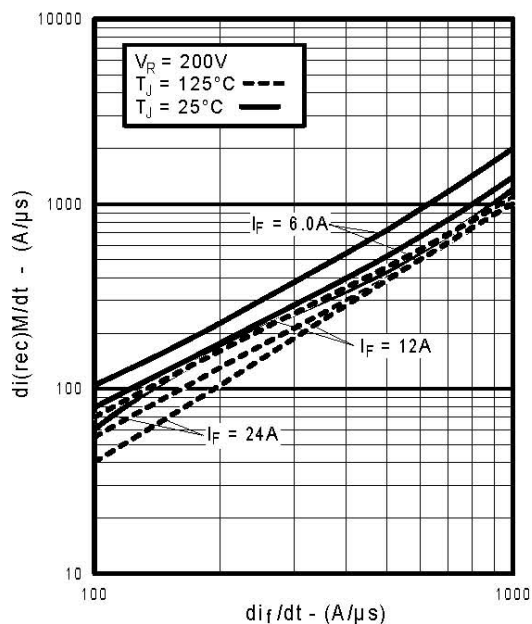
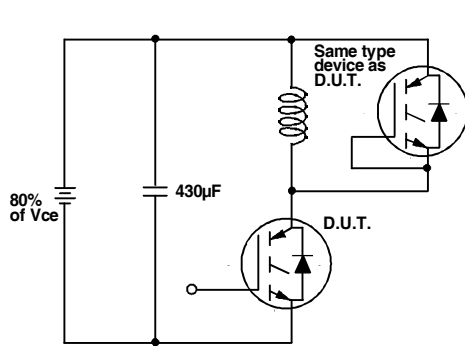


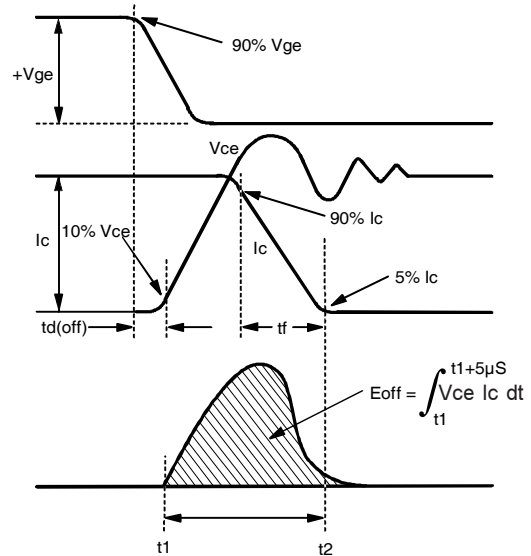
Fig. 17 - Typical  $di_{(rec)M}/dt$  vs.  $di_f/dt$



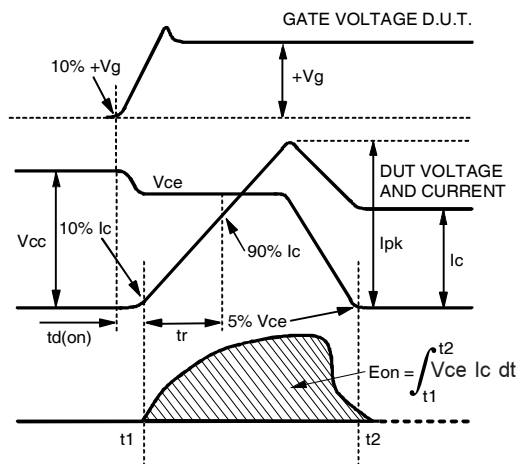
# IRG4BC30FD-SPbF



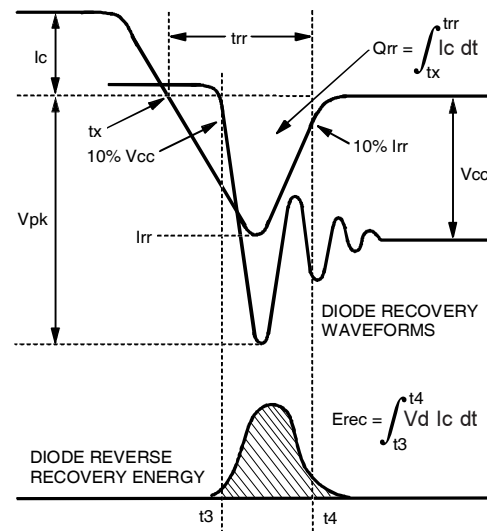
**Fig. 18a** - Test Circuit for Measurement of  $I_{LM}$ ,  $E_{on}$ ,  $E_{off}(\text{diode})$ ,  $t_{rr}$ ,  $Q_{rr}$ ,  $I_{rr}$ ,  $t_{d(on)}$ ,  $t_r$ ,  $t_{d(off)}$ ,  $t_f$



**Fig. 18b** - Test Waveforms for Circuit of Fig. 18a, Defining  $E_{off}$ ,  $t_{d(off)}$ ,  $t_f$

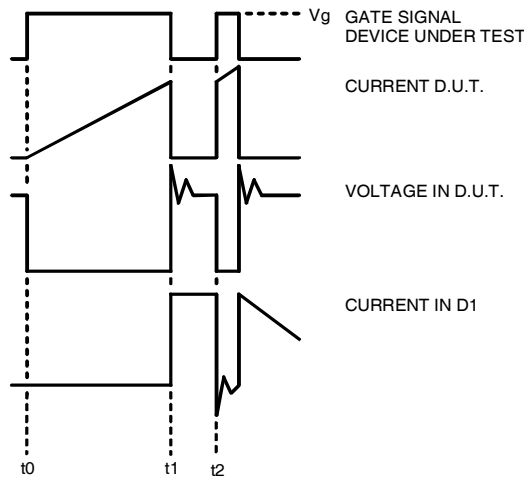


**Fig. 18c** - Test Waveforms for Circuit of Fig. 18a, Defining  $E_{on}$ ,  $t_{d(on)}$ ,  $t_r$

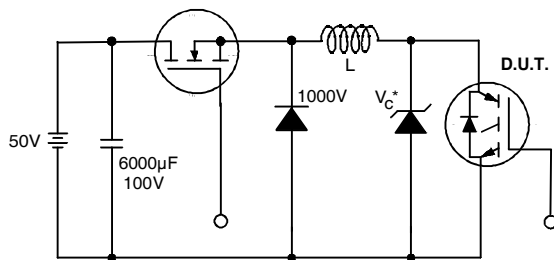


**Fig. 18d** - Test Waveforms for Circuit of Fig. 18a, Defining  $E_{rec}$ ,  $t_{rr}$ ,  $Q_{rr}$ ,  $I_{rr}$

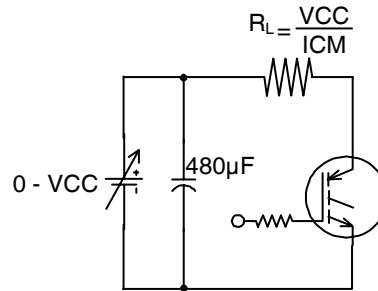




**Fig.18e** - Macro Waveforms for Figure 18a's Test Circuit



**Fig. 19** - Clamped Inductive Load Test Circuit



Pulsed Collector Current  
 Test Circuit

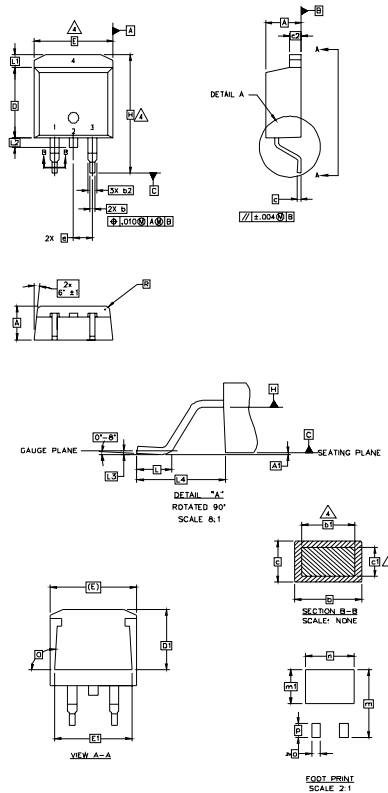
**Fig. 20** - Pulsed Collector Current  
 Test Circuit

# IRG4BC30FD-SPbF



## D<sup>2</sup>Pak Package Outline

Dimensions are shown in millimeters (inches)



### NOTES:

1. DIMENSIONING AND TOLERANCING PER ASME Y14.5M-1994
2. DIMENSIONS ARE SHOWN IN MILLIMETERS [INCHES].
3. DIMENSION D & E DO NOT INCLUDE MOLD FLASH. MOLD FLASH SHALL NOT EXCEED 0.127 [0.005"] PER SIDE. THESE DIMENSIONS ARE MEASURED AT THE OUTMOST EXTREMES OF THE PLASTIC BODY.
4. DIMENSION b1 AND c1 APPLY TO BASE METAL ONLY.
5. CONTROLLING DIMENSION: INCH.

| SYMBOL | DIMENSIONS  |       |          |      | NOTES |
|--------|-------------|-------|----------|------|-------|
|        | MILLIMETERS |       | INCHES   |      |       |
|        | MIN.        | MAX.  | MIN.     | MAX. |       |
| A      | 4.06        | 4.83  | .160     | .190 |       |
| A1     | 0.00        | 0.254 | .000     | .010 |       |
| b      | 0.51        | 0.99  | .020     | .039 |       |
| b1     | 0.51        | 0.89  | .020     | .035 | 4     |
| b2     | 1.14        | 1.78  | .045     | .070 |       |
| c      | 0.38        | 0.74  | .015     | .029 |       |
| c1     | 0.38        | 0.58  | .015     | .023 | 4     |
| c2     | 1.14        | 1.65  | .045     | .065 |       |
| D      | 8.51        | 9.65  | .335     | .380 | 3     |
| D1     | 6.86        |       | .270     |      |       |
| E      | 9.65        | 10.67 | .380     | .420 | 3     |
| E1     | 6.22        |       | .245     |      |       |
| e      | 2.54 BSC    |       | .100 BSC |      |       |
| H      | 14.61       | 15.88 | .575     | .625 |       |
| L      | 1.78        | 2.79  | .070     | .110 |       |
| L1     |             | 1.65  | .065     |      |       |
| L2     | 1.27        | 1.78  | .050     | .070 |       |
| L3     | 0.25 BSC    |       | .010 BSC |      |       |
| L4     | 4.78        | 5.28  | .188     | .208 |       |
| m      | 17.78       |       | .700     |      |       |
| m1     | 8.89        |       | .350     |      |       |
| n      | 11.43       |       | .450     |      |       |
| o      | 2.08        |       | .082     |      |       |
| p      | 3.81        |       | .150     |      |       |
| R      | 0.51        | 0.71  | .020     | .028 |       |
| θ      | 90°         | 93°   | 90°      | 93°  |       |

### LEAD ASSIGNMENTS

#### HEXFET

- 1.- GATE
- 2, 4.- DRAIN
- 3.- SOURCE

#### IGBTs, CoPACK

- 1.- GATE
- 2, 4.- COLLECTOR
- 3.- EMITTER

#### DIODES

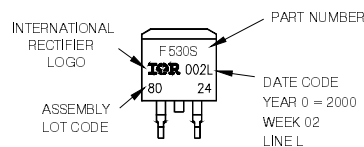
- 1.- ANODE \*
- 2, 4.- CATHODE
- 3.- ANODE

\* PART DEPENDENT.

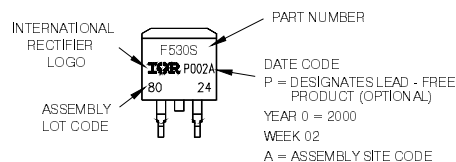
## D<sup>2</sup>Pak Part Marking Information

EXAMPLE: THIS IS AN IRF530S WITH  
LOT CODE 8024  
ASSEMBLED ON WW 02, 2000  
IN THE ASSEMBLY LINE "L"

Note: "P" in assembly line position  
indicates "Lead - Free"



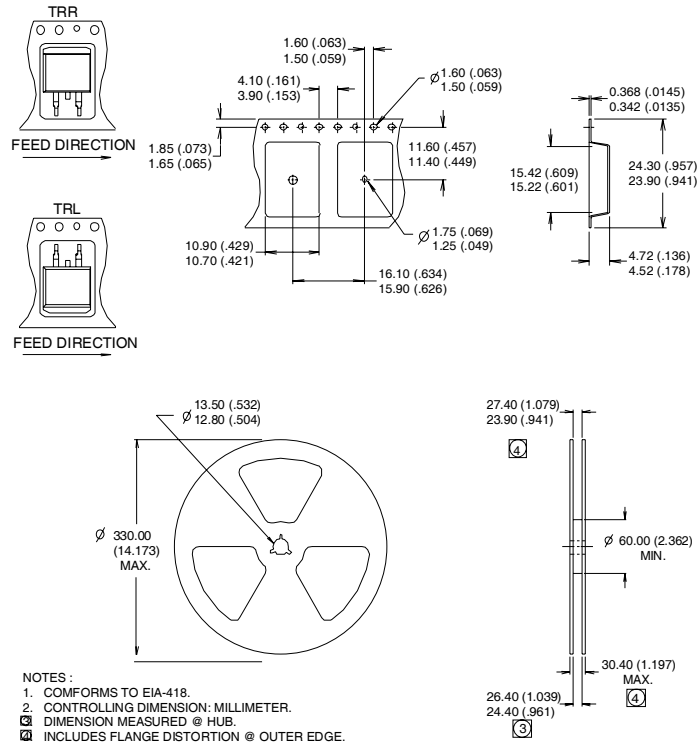
OR



Note: For the most current drawing please refer to IR website at <http://www.irf.com/package/>

## D<sup>2</sup>Pak Tape & Reel Information

Dimensions are shown in millimeters (inches)



### Notes:

- ① Repetitive rating:  $V_{GE}=20V$ ; pulse width limited by maximum junction temperature (figure 20).
- ②  $V_{CC}=80\%(V_{CES})$ ,  $V_{GE}=20V$ ,  $L=10\mu H$ ,  $R_G = 23\Omega$  (figure 19).
- ③ Pulse width  $\leq 80\mu s$ ; duty factor  $\leq 0.1\%$ .
- ④ Pulse width  $5.0\mu s$ , single shot.
- ⑤ When mounted on 1" square PCB (FR-4 or G-10 Material).

Data and specifications subject to change without notice.

International  
**IR** Rectifier

**IR WORLD HEADQUARTERS:** 233 Kansas St., El Segundo, California 90245, USA Tel: (310) 252-7105

TAC Fax: (310) 252-7903

Visit us at [www.irf.com](http://www.irf.com) for sales contact information. 01/2010

单击下面可查看定价，库存，交付和生命周期等信息

[>>Infineon Technologies\(英飞凌\)](#)