

1812L Series

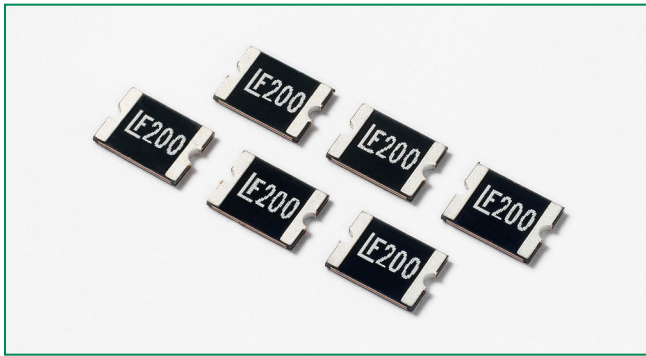

Description

The 1812L Series PTC provides surface mount overcurrent protection for applications where resettable protection is desired.

Features

- RoHS compliant, lead-free and halogen-free
- Fast response
- Compact design
- Low resistance
- Low-profile
- Compatible with high temperature solders

Applications

- Plug and play protection for motherboards and peripherals
- USB peripherals
- PCI cards
- Game console port protection

Agency Approvals

| AGENCY | AGENCY FILE NUMBER |
|--------|--------------------|
| | E183209 |
| | R50119118 |

Electrical Characteristics

| Part Number | Marking | I _{hold} (A) | I _{trip} (A) | V _{max} (Vdc) | I _{max} (A) | P _d typ. (W) | Max. Time To Trip | | Resistance | | Agency Approvals | |
|--------------------------|----------|-----------------------|-----------------------|------------------------|----------------------|-------------------------|-------------------|-------------|----------------------|-----------------------|------------------|---|
| | | | | | | | Current (A) | Time (Sec.) | R _{min} (Ω) | R _{1max} (Ω) | | |
| 1812L010 | LF010 | 0.10 | 0.30 | 30 | 100 | 0.8 | 0.50 | 1.50 | 1.600 | 15.000 | X | X |
| 1812L010/60 | LF010-60 | 0.10 | 0.30 | 60 | 10 | 0.8 | 0.50 | 1.50 | 1.600 | 15.000 | X | X |
| 1812L014 | LF014 | 0.14 | 0.34 | 60 | 10 | 0.8 | 1.50 | 0.15 | 1.500 | 6.000 | X | X |
| 1812L020 | LF020 | 0.20 | 0.40 | 30 | 100 | 0.8 | 8.00 | 0.02 | 0.800 | 5.000 | X | X |
| 1812L020/60 | LF020-60 | 0.20 | 0.40 | 60 | 40 | 0.8 | 1.00 | 2.00 | 1.400 | 4.400 | X | X |
| 1812L035/30 | LF035-30 | 0.35 | 0.75 | 30 | 40 | 0.8 | 8.00 | 0.15 | 0.400 | 1.700 | X | X |
| 1812L035/60 | LF035-60 | 0.35 | 0.70 | 60 | 10 | 1.00 | 8.00 | 0.15 | 0.400 | 1.700 | X | X |
| 1812L050 ¹ | LF050 | 0.50 | 1.00 | 15 | 100 | 0.8 | 8.00 | 0.15 | 0.150 | 1.000 | X | X |
| 1812L050/30 | LF050-30 | 0.50 | 1.00 | 30 | 100 | 0.8 | 8.00 | 0.15 | 0.150 | 1.000 | X | X |
| 1812L050/60 | LF050-60 | 0.50 | 1.00 | 60 | 10 | 1.50 | 8.00 | 0.15 | 0.150 | 1.000 | X | X |
| 1812L075 ¹ | LF075 | 0.75 | 1.50 | 13.2 | 100 | 0.8 | 8.00 | 0.20 | 0.100 | 0.450 | X | X |
| 1812L075/24 ² | LF075-24 | 0.75 | 1.50 | 24 | 100 | 0.8 | 8.00 | 0.20 | 0.110 | 0.290 | X | X |
| 1812L075/33 | LF075-33 | 0.75 | 1.50 | 33 | 20 | 0.8 | 8.00 | 0.20 | 0.110 | 0.400 | X | X |
| 1812L110 ¹ | LF110 | 1.10 | 2.20 | 8 | 100 | 0.8 | 8.00 | 0.30 | 0.040 | 0.210 | X | X |
| 1812L110/16 | LF110-16 | 1.10 | 1.95 | 16 | 100 | 0.8 | 8.00 | 0.30 | 0.060 | 0.180 | X | X |
| 1812L110/24 | LF110-24 | 1.10 | 1.95 | 24 | 20 | 0.8 | 8.00 | 0.50 | 0.060 | 0.200 | X | X |
| 1812L110/33 | LF110-33 | 1.10 | 1.95 | 33 | 20 | 0.8 | 8.00 | 0.50 | 0.060 | 0.200 | X | X |
| 1812L125/6 | LF125-6 | 1.25 | 2.50 | 6 | 100 | 0.8 | 8.00 | 0.40 | 0.050 | 0.140 | X | X |
| 1812L125/16 | LF125 | 1.25 | 2.50 | 16 | 100 | 0.8 | 8.00 | 0.40 | 0.050 | 0.140 | X | X |
| 1812L150 ¹ | LF150 | 1.50 | 3.00 | 8 | 100 | 0.8 | 8.00 | 0.30 | 0.040 | 0.110 | X | X |
| 1812L150/12 | LF150-12 | 1.50 | 3.00 | 12 | 100 | 0.8 | 8.00 | 0.50 | 0.040 | 0.110 | X | X |
| 1812L150/16 | LF150-16 | 1.50 | 2.80 | 16 | 100 | 0.8 | 8.00 | 0.50 | 0.040 | 0.110 | X | X |
| 1812L150/24 ² | LF150-24 | 1.50 | 3.00 | 24 | 20 | 0.8 | 8.00 | 1.50 | 0.040 | 0.120 | X | X |
| 1812L160 ¹ | LF160 | 1.60 | 2.80 | 8 | 100 | 0.8 | 8.00 | 1.00 | 0.030 | 0.100 | X | X |
| 1812L160/12 | LF160-12 | 1.60 | 2.80 | 12 | 100 | 0.8 | 8.00 | 1.00 | 0.030 | 0.100 | X | X |
| 1812L200TH ¹ | LF200 | 2.00 | 3.50 | 8 | 100 | 0.8 | 8.00 | 2.00 | 0.020 | 0.070 | X | X |

continues on next page.



I_{hold} = Hold current: maximum current device will pass without tripping in 20°C still air.
 I_{trip} = Trip current: minimum current at which the device will trip in 20°C still air.
 V_{max} = Maximum voltage device can withstand without damage at rated current (I_{max})
 I_{max} = Maximum fault current device can withstand without damage at rated voltage (V_{max})
 P_d = Power dissipated from device when in the tripped state at 20°C still air.

R_{min} = Minimum resistance of device in initial (un-soldered) state.
 R_{typ} = Typical resistance of device in initial (un-soldered) state.
 R_{1max} = Maximum resistance of device at 20°C measured one hour after tripping or reflow soldering of 260°C for 20 sec.

Caution: Operation beyond the specified rating may result in damage and possible arcing and flame.

1 Some older references to these devices may include “-C” in the Part Number. The “-C” should be omitted when placing new orders for the device.
 2 Part Number with note 2 tested and complied with AEC Q200.

Electrical Characteristics

| Part Number | Marking | I _{hold} (A) | I _{trip} (A) | V _{max} (Vdc) | I _{max} (A) | P _d typ. (W) | Max. Time To Trip | | Resistance | | Agency Approvals | |
|-------------------------|----------|-----------------------|-----------------------|------------------------|----------------------|-------------------------|-------------------|-------------|----------------------|-----------------------|---|---|
| | | | | | | | Current (A) | Time (Sec.) | R _{min} (Ω) | R _{1max} (Ω) |  |  |
| 1812L200/12 | LF200-12 | 2.00 | 3.50 | 12 | 100 | 1.0 | 8.00 | 2.00 | 0.020 | 0.070 | X | X |
| 1812L200/16 | LF200-16 | 2.00 | 3.50 | 16 | 100 | 1.0 | 8.00 | 2.00 | 0.020 | 0.070 | X | X |
| 1812L260TH ¹ | LF260 | 2.60 | 5.20 | 8 | 100 | 0.8 | 8.00 | 2.50 | 0.015 | 0.047 | X | X |
| 1812L260/12 | LF260-12 | 2.60 | 5.00 | 12 | 100 | 0.8 | 8.00 | 5.00 | 0.015 | 0.055 | X | X |
| 1812L260/16 | LF260-16 | 2.60 | 5.00 | 16 | 100 | 1.2 | 8.00 | 5.00 | 0.015 | 0.050 | X | X |
| 1812L300 | LF300 | 3.00 | 5.00 | 6 | 100 | 0.8 | 8.00 | 4.00 | 0.012 | 0.040 | X | X |

I_{hold} = Hold current: maximum current device will pass without tripping in 20°C still air.
 I_{trip} = Trip current: minimum current at which the device will trip in 20°C still air.
 V_{max} = Maximum voltage device can withstand without damage at rated current (I_{max})
 I_{max} = Maximum fault current device can withstand without damage at rated voltage (V_{max})
 P_d = Power dissipated from device when in the tripped state at 20°C still air.
 R_{min} = Minimum resistance of device in initial (un-soldered) state.
 R_{typ} = Typical resistance of device in initial (un-soldered) state.
 R_{1max} = Maximum resistance of device at 20°C measured one hour after tripping or reflow soldering of 260°C for 20 sec.

Caution: Operation beyond the specified rating may result in damage and possible arcing and flame.

- 1 Some older references to these devices may include “-C” in the Part Number. The “-C” should be omitted when placing new orders for the device.
- 2 Part Number with note 2 tested and complied with AEC Q200.

Temperature Derating

| Part Number | Ambient Operation Temperature | | | | | | | | |
|-------------|-------------------------------|-------|------|------|------|------|------|------|------|
| | -40°C | -20°C | 0°C | 20°C | 40°C | 50°C | 60°C | 70°C | 85°C |
| | Hold Current (A) | | | | | | | | |
| 1812L010 | 0.16 | 0.14 | 0.12 | 0.10 | 0.08 | 0.07 | 0.06 | 0.05 | 0.03 |
| 1812L010/60 | 0.14 | 0.13 | 0.11 | 0.10 | 0.09 | 0.08 | 0.07 | 0.07 | 0.05 |
| 1812L014 | 0.23 | 0.19 | 0.17 | 0.14 | 0.12 | 0.10 | 0.09 | 0.08 | 0.06 |
| 1812L020 | 0.29 | 0.26 | 0.23 | 0.20 | 0.17 | 0.15 | 0.14 | 0.12 | 0.10 |
| 1812L020/60 | 0.29 | 0.26 | 0.23 | 0.20 | 0.17 | 0.15 | 0.14 | 0.12 | 0.10 |
| 1812L035/30 | 0.50 | 0.45 | 0.40 | 0.35 | 0.30 | 0.26 | 0.24 | 0.20 | 0.16 |
| 1812L035/60 | 0.52 | 0.46 | 0.40 | 0.35 | 0.30 | 0.26 | 0.24 | 0.19 | 0.15 |
| 1812L050 | 0.77 | 0.68 | 0.59 | 0.50 | 0.44 | 0.40 | 0.37 | 0.33 | 0.29 |
| 1812L050/30 | 0.77 | 0.68 | 0.59 | 0.50 | 0.44 | 0.40 | 0.37 | 0.33 | 0.29 |
| 1812L050/60 | 0.72 | 0.66 | 0.57 | 0.50 | 0.44 | 0.39 | 0.35 | 0.31 | 0.24 |
| 1812L075 | 1.15 | 1.01 | 0.88 | 0.75 | 0.65 | 0.60 | 0.55 | 0.49 | 0.43 |
| 1812L075/24 | 1.06 | 0.95 | 0.84 | 0.75 | 0.60 | 0.55 | 0.50 | 0.45 | 0.37 |
| 1812L075/33 | 1.10 | 1.00 | 0.88 | 0.75 | 0.66 | 0.60 | 0.56 | 0.47 | 0.36 |
| 1812L110 | 1.59 | 1.43 | 1.26 | 1.10 | 0.95 | 0.87 | 0.80 | 0.71 | 0.60 |
| 1812L110/16 | 1.58 | 1.43 | 1.27 | 1.10 | 0.95 | 0.85 | 0.77 | 0.71 | 0.58 |
| 1812L110/24 | 1.55 | 1.40 | 1.25 | 1.10 | 0.93 | 0.83 | 0.73 | 0.63 | 0.50 |
| 1812L110/33 | 1.55 | 1.40 | 1.25 | 1.10 | 0.93 | 0.83 | 0.73 | 0.63 | 0.50 |
| 1812L125/6 | 2.00 | 1.75 | 1.52 | 1.25 | 1.00 | 0.95 | 0.90 | 0.75 | 0.53 |
| 1812L125/16 | 2.00 | 1.75 | 1.52 | 1.25 | 1.00 | 0.95 | 0.90 | 0.75 | 0.53 |
| 1812L150 | 2.06 | 1.93 | 1.79 | 1.50 | 1.28 | 1.10 | 1.02 | 0.80 | 0.68 |
| 1812L150/12 | 2.04 | 1.88 | 1.68 | 1.50 | 1.25 | 1.10 | 1.00 | 0.80 | 0.60 |
| 1812L150/16 | 2.04 | 1.88 | 1.68 | 1.50 | 1.25 | 1.10 | 1.00 | 0.80 | 0.60 |
| 1812L150/24 | 2.05 | 1.87 | 1.67 | 1.50 | 1.25 | 1.08 | 0.95 | 0.77 | 0.60 |
| 1812L160 | 2.20 | 2.06 | 1.91 | 1.60 | 1.36 | 1.17 | 1.09 | 0.85 | 0.72 |
| 1812L160/12 | 2.20 | 2.06 | 1.91 | 1.60 | 1.36 | 1.17 | 1.09 | 0.85 | 0.72 |
| 1812L200TH | 2.60 | 2.44 | 2.22 | 2.00 | 1.78 | 1.67 | 1.50 | 1.45 | 1.29 |
| 1812L200/12 | 2.80 | 2.60 | 2.36 | 2.00 | 1.72 | 1.56 | 1.40 | 1.20 | 1.04 |
| 1812L200/16 | 2.80 | 2.60 | 2.36 | 2.00 | 1.72 | 1.56 | 1.40 | 1.20 | 1.04 |
| 1812L260TH | 3.40 | 3.16 | 3.00 | 2.60 | 2.30 | 2.15 | 2.00 | 1.85 | 1.63 |
| 1812L260/12 | 3.40 | 3.16 | 3.00 | 2.60 | 2.30 | 2.15 | 2.00 | 1.85 | 1.63 |
| 1812L260/16 | 3.66 | 3.30 | 2.96 | 2.60 | 2.23 | 2.06 | 1.89 | 1.61 | 1.30 |
| 1812L300 | 4.13 | 3.75 | 3.30 | 3.00 | 2.61 | 2.43 | 2.25 | 2.00 | 1.78 |

Notes: The temperature derating data is only for reference, please contact Littelfuse technical support for detail temperature derating information.

© 2017 Littelfuse, Inc.
 Specifications are subject to change without notice.
 Revised: 07/21/17

Temperature Derating Curve

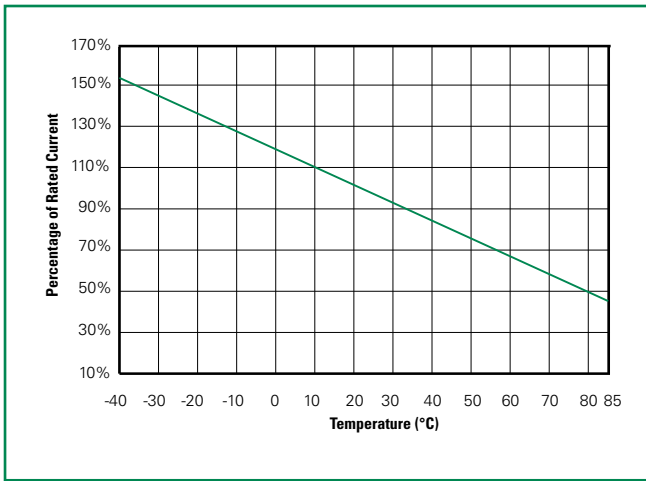

Note:
Typical Temperature derating curve, refer to table for derating data

Physical Specifications

| | |
|---------------------------|--|
| Terminal Material | Solder-Plated Copper (Solder Material: Matte Tin (Sn)) |
| Lead Solderability | Meets EIA Specification RS186-9E, ANSI/J-STD-002 Category 3. |

Environmental Specifications

| | |
|---|---|
| Operating/Storage Temp. | -40°C to +85°C |
| Max. Device Surface Temp. in Tripped State | 125°C |
| Passive Aging | +85°C, 1000 hours -/+5% typical resistance change |
| Humidity Aging | +85°C, 85% R.H., 1000 hours -/+5% typical resistance change |
| Thermal Shock | MIL-STD-202, Method 107 +85°C/-40°C 20 times -30% typical resistance change |
| Solvent Resistance | MIL-STD-202, Method 215, No change |
| Vibration | MIL-STD-883, Method 2007, Condition A, No change |
| Moisture Level Sensitivity | Level 1, J-STD-020 |

Soldering Parameters

| | | |
|--|----------------------------------|------------------|
| Profile Feature | Pb-Free Assembly | |
| Average Ramp-Up Rate ($T_{S(max)}$ to T_p) | 3°C/second max | |
| Pre Heat: | Temperature Min ($T_{S(min)}$) | 150°C |
| | Temperature Max ($T_{S(max)}$) | 200°C |
| | Time (Min to Max) (t_s) | 60 – 180 secs |
| Time Maintained Above: | Temperature (T_L) | 217°C |
| | Temperature (t_L) | 60 – 150 seconds |
| Peak / Classification Temperature (T_p) | 260 ^{+0/-5} °C | |
| Time within 5°C of actual peak Temperature (t_p) | 20 – 40 seconds | |
| Ramp-down Rate | 6°C/second max | |
| Time 25°C to peak Temperature (T_p) | 8 minutes Max. | |

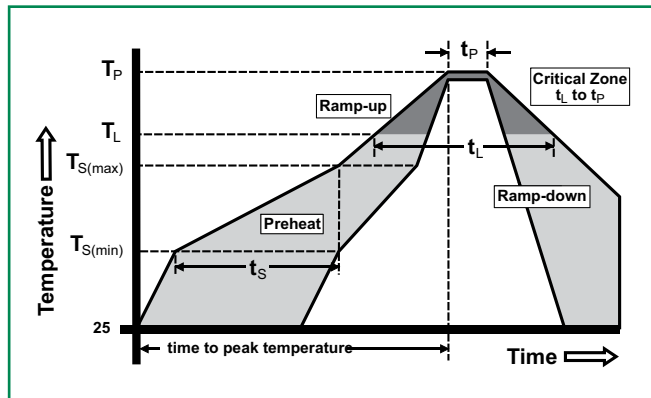

- All temperature refer to topside of the package, measured on the package body surface
- If reflow temperature exceeds the recommended profile, devices may not meet the performance requirements
- Recommended reflow methods: IR, vapor phase oven, hot air oven, N₂ environment for lead
- Recommended maximum paste thickness is 0.25mm (0.010inch)
- Devices can be cleaned using standard industry methods and solvents
- Devices can be reworked using the standard industry practices

Average Time Current Curves

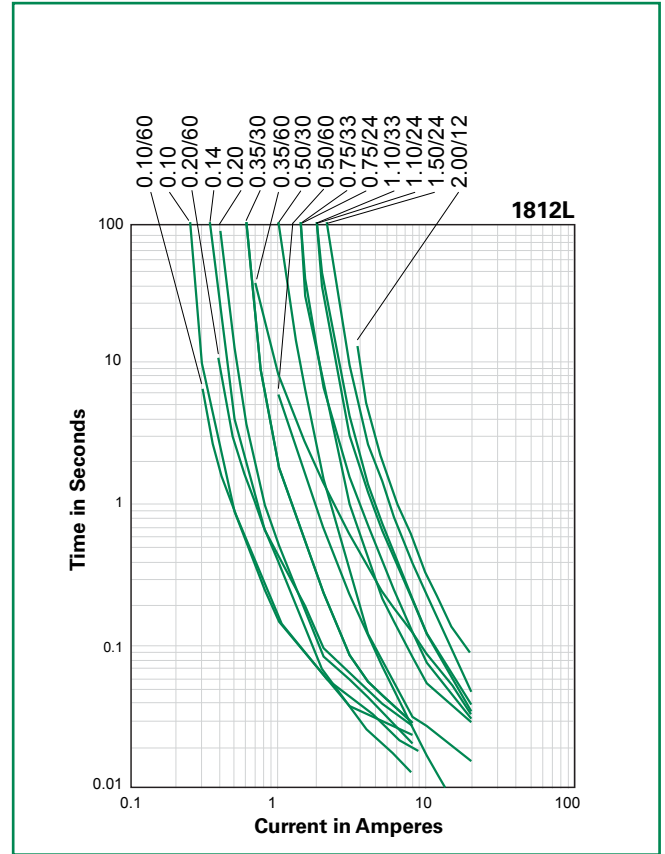
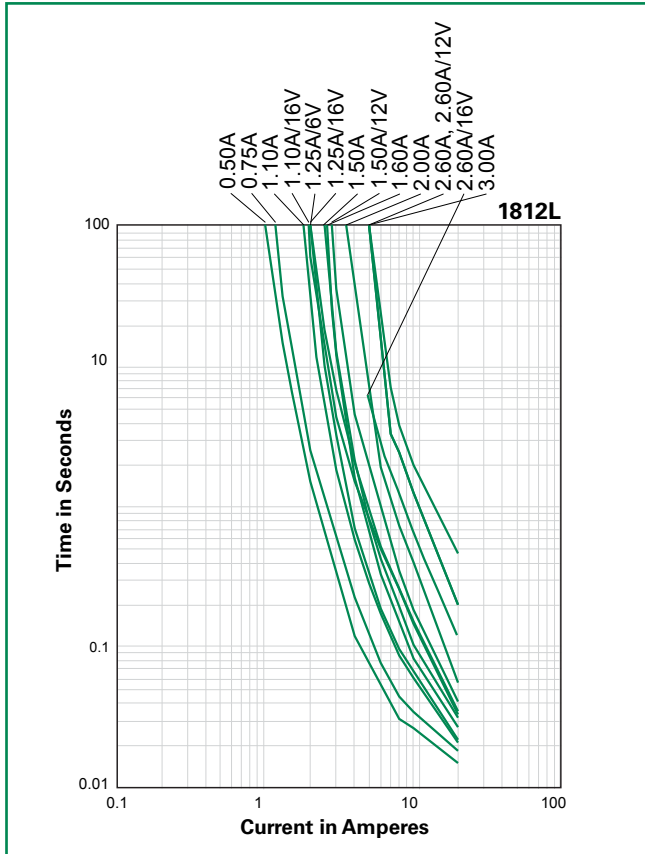

The average time current curves and Temperature Rerating curve performance is affected by a number of variables, and these curves provided as guidance only. Customer must verify the performance in their application.

Additional Information



Datasheet



Resources



Samples

Dimensions

MARKING CODE VARIES
WITH AMPERAGE AND VOLTAGE RATING
(See Electrical Characteristics Table)
SHOWN ARE:
- 1.1A/6V RATING (LEFT)
- 1.1A/33V RATING (RIGHT)

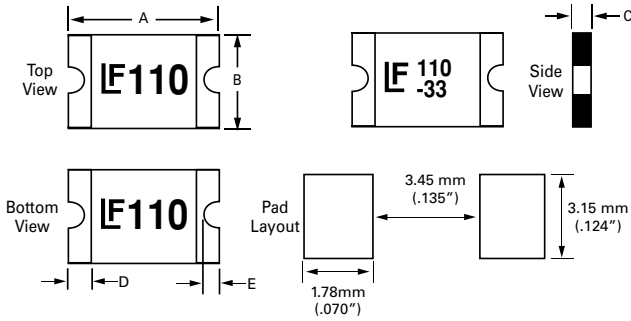

| Part Number | A | | | | B | | | | C | | | | D | | | | E | | | |
|-------------|--------|------|------|------|--------|------|------|------|--------|-------|------|------|--------|-------|-----|------|--------|-------|------|------|
| | Inches | | mm | | Inches | | mm | | Inches | | mm | | Inches | | mm | | Inches | | mm | |
| | Min | Max | Min | Max | Min | Max | Min | Max | Min | Max | Min | Max | Min | Max | Min | Max | Min | Max | Min | Max |
| 1812L010 | 0.17 | 0.19 | 4.37 | 4.73 | 0.12 | 0.13 | 3.07 | 3.41 | 0.03 | 0.05 | 0.75 | 1.25 | 0.01 | 0.05 | 0.3 | 1.2 | 0.01 | 0.03 | 0.15 | 0.65 |
| 1812L010/60 | 0.17 | 0.19 | 4.37 | 4.73 | 0.12 | 0.13 | 3.07 | 3.41 | 0.03 | 0.05 | 0.75 | 1.25 | 0.01 | 0.05 | 0.3 | 1.2 | 0.01 | 0.03 | 0.15 | 0.65 |
| 1812L014 | 0.17 | 0.19 | 4.37 | 4.73 | 0.12 | 0.13 | 3.07 | 3.41 | 0.03 | 0.08 | 0.75 | 1.95 | 0.01 | 0.05 | 0.3 | 1.2 | 0.01 | 0.03 | 0.15 | 0.65 |
| 1812L020 | 0.17 | 0.19 | 4.37 | 4.73 | 0.12 | 0.13 | 3.07 | 3.41 | 0.02 | 0.04 | 0.55 | 1.00 | 0.01 | 0.05 | 0.3 | 1.2 | 0.01 | 0.03 | 0.15 | 0.65 |
| 1812L020/60 | 0.17 | 0.19 | 4.37 | 4.73 | 0.12 | 0.13 | 3.07 | 3.41 | 0.03 | 0.05 | 0.75 | 1.25 | 0.01 | 0.05 | 0.3 | 1.20 | 0.01 | 0.03 | 0.15 | 0.65 |
| 1812L035/30 | 0.17 | 0.19 | 4.37 | 4.73 | 0.12 | 0.13 | 3.07 | 3.41 | 0.02 | 0.04 | 0.6 | 1.25 | 0.01 | 0.05 | 0.3 | 1.20 | 0.01 | 0.03 | 0.15 | 0.65 |
| 1812L035/60 | 0.17 | 0.19 | 4.37 | 4.73 | 0.12 | 0.13 | 3.07 | 3.41 | 0.05 | 0.07 | 1.2 | 1.8 | 0.01 | 0.05 | 0.3 | 1.2 | 0.01 | 0.03 | 0.15 | 0.65 |
| 1812L050 | 0.17 | 0.19 | 4.37 | 4.73 | 0.12 | 0.13 | 3.07 | 3.41 | 0.02 | 0.03 | 0.5 | 0.75 | 0.01 | 0.05 | 0.3 | 1.2 | 0.01 | 0.02 | 0.15 | 0.50 |
| 1812L050/30 | 0.17 | 0.19 | 4.37 | 4.73 | 0.12 | 0.13 | 3.07 | 3.41 | 0.02 | 0.04 | 0.5 | 1.00 | 0.01 | 0.05 | 0.3 | 1.2 | 0.01 | 0.03 | 0.15 | 0.65 |
| 1812L050/60 | 0.17 | 0.19 | 4.37 | 4.73 | 0.12 | 0.13 | 3.07 | 3.41 | 0.05 | 0.07 | 1.2 | 1.8 | 0.01 | 0.05 | 0.3 | 1.2 | 0.01 | 0.03 | 0.15 | 0.65 |
| 1812L075 | 0.17 | 0.19 | 4.37 | 4.73 | 0.12 | 0.13 | 3.07 | 3.41 | 0.02 | 0.03 | 0.5 | 0.75 | 0.01 | 0.05 | 0.3 | 1.2 | 0.01 | 0.02 | 0.15 | 0.50 |
| 1812L075/24 | 0.17 | 0.19 | 4.37 | 4.73 | 0.12 | 0.13 | 3.07 | 3.41 | 0.03 | 0.05 | 0.75 | 1.20 | 0.01 | 0.05 | 0.3 | 1.2 | 0.01 | 0.03 | 0.15 | 0.65 |
| 1812L075/33 | 0.17 | 0.19 | 4.37 | 4.73 | 0.12 | 0.13 | 3.07 | 3.41 | 0.03 | 0.06 | 0.75 | 1.55 | 0.01 | 0.05 | 0.3 | 1.2 | 0.01 | 0.03 | 0.15 | 0.65 |
| 1812L110 | 0.17 | 0.19 | 4.37 | 4.73 | 0.12 | 0.13 | 3.07 | 3.41 | 0.02 | 0.03 | 0.50 | 0.71 | 0.01 | 0.05 | 0.3 | 1.2 | 0.01 | 0.02 | 0.15 | 0.65 |
| 1812L110/24 | 0.17 | 0.19 | 4.37 | 4.73 | 0.12 | 0.13 | 3.07 | 3.41 | 0.02 | 0.04 | 0.50 | 1.07 | 0.01 | 0.05 | 0.3 | 1.2 | 0.01 | 0.03 | 0.15 | 0.65 |
| 1812L110/16 | 0.17 | 0.19 | 4.37 | 4.73 | 0.12 | 0.13 | 3.07 | 3.41 | 0.03 | 0.05 | 0.75 | 1.25 | 0.01 | 0.05 | 0.3 | 1.2 | 0.01 | 0.03 | 0.15 | 0.65 |
| 1812L110/33 | 0.17 | 0.19 | 4.37 | 4.73 | 0.12 | 0.13 | 3.07 | 3.41 | 0.05 | 0.08 | 1.20 | 2.00 | 0.01 | 0.05 | 0.3 | 1.2 | 0.01 | 0.03 | 0.15 | 0.65 |
| 1812L125/6 | 0.17 | 0.19 | 4.37 | 4.73 | 0.12 | 0.13 | 3.07 | 3.41 | 0.02 | 0.03 | 0.45 | 0.75 | 0.01 | 0.05 | 0.3 | 1.2 | 0.01 | 0.03 | 0.15 | 0.65 |
| 1812L125/16 | 0.17 | 0.19 | 4.37 | 4.73 | 0.12 | 0.13 | 3.07 | 3.41 | 0.03 | 0.05 | 0.75 | 1.25 | 0.01 | 0.05 | 0.3 | 1.2 | 0.01 | 0.02 | 0.15 | 0.65 |
| 1812L150 | 0.17 | 0.19 | 4.37 | 4.73 | 0.12 | 0.13 | 3.07 | 3.41 | 0.02 | 0.03 | 0.40 | 0.71 | 0.01 | 0.05 | 0.3 | 1.2 | 0.01 | 0.03 | 0.15 | 0.65 |
| 1812L150/12 | 0.17 | 0.19 | 4.37 | 4.73 | 0.12 | 0.13 | 3.07 | 3.41 | 0.03 | 0.05 | 0.75 | 1.25 | 0.01 | 0.05 | 0.3 | 1.2 | 0.01 | 0.03 | 0.15 | 0.65 |
| 1812L150/16 | 0.17 | 0.19 | 4.37 | 4.73 | 0.12 | 0.13 | 3.07 | 3.41 | 0.03 | 0.05 | 0.75 | 1.25 | 0.01 | 0.05 | 0.3 | 1.2 | 0.01 | 0.03 | 0.15 | 0.65 |
| 1812L150/24 | 0.17 | 0.19 | 4.37 | 4.73 | 0.12 | 0.13 | 3.07 | 3.41 | 0.03 | 0.07 | 0.80 | 1.8 | 0.01 | 0.05 | 0.3 | 1.2 | 0.01 | 0.03 | 0.15 | 0.65 |
| 1812L160 | 0.17 | 0.19 | 4.37 | 4.73 | 0.12 | 0.13 | 3.07 | 3.41 | 0.02 | 0.03 | 0.40 | 0.75 | 0.01 | 0.05 | 0.3 | 1.2 | 0.01 | 0.03 | 0.15 | 0.65 |
| 1812L160/12 | 0.17 | 0.19 | 4.37 | 4.73 | 0.12 | 0.13 | 3.07 | 3.41 | 0.03 | 0.05 | 0.75 | 1.25 | 0.01 | 0.05 | 0.3 | 1.2 | 1.2 | 0.01 | 0.15 | 0.65 |
| 1812L200TH | 0.17 | 0.19 | 4.37 | 4.73 | 0.12 | 0.13 | 3.07 | 3.41 | 0.008 | 0.024 | 0.20 | 0.6 | 0.01 | 0.05 | 0.3 | 1.2 | 0.01 | 0.02 | 0.15 | 0.65 |
| 1812L200/12 | 0.17 | 0.19 | 4.37 | 4.73 | 0.12 | 0.13 | 3.07 | 3.41 | 0.03 | 0.05 | 0.80 | 1.20 | 0.012 | 0.047 | 0.3 | 1.2 | 0.01 | 0.026 | 0.15 | 0.65 |
| 1812L200/16 | 0.17 | 0.19 | 4.37 | 4.73 | 0.12 | 0.13 | 3.07 | 3.41 | 0.03 | 0.05 | 0.80 | 1.20 | 0.012 | 0.047 | 0.3 | 1.2 | 0.01 | 0.026 | 0.15 | 0.65 |
| 1812L260TH | 0.17 | 0.19 | 4.37 | 4.73 | 0.12 | 0.13 | 3.07 | 3.41 | 0.02 | 0.04 | 0.50 | 1.00 | 0.01 | 0.05 | 0.3 | 1.2 | 0.01 | 0.02 | 0.15 | 0.65 |
| 1812L260/12 | 0.17 | 0.19 | 4.37 | 4.73 | 0.12 | 0.13 | 3.07 | 3.41 | 0.03 | 0.05 | 0.80 | 1.34 | 0.01 | 0.05 | 0.3 | 1.2 | 0.01 | 0.03 | 0.15 | 0.65 |
| 1812L260/16 | 0.18 | 0.19 | 4.54 | 4.90 | 0.12 | 0.14 | 3.16 | 3.50 | 0.05 | 0.08 | 1.20 | 2.00 | 0.012 | 0.047 | 0.3 | 1.2 | 0.006 | 0.03 | 0.15 | 0.65 |
| 1812L300 | 0.17 | 0.19 | 4.37 | 4.73 | 0.12 | 0.13 | 3.07 | 3.41 | 0.02 | 0.06 | 0.50 | 1.50 | 0.01 | 0.05 | 0.3 | 1.2 | 0.01 | 0.03 | 0.15 | 0.65 |

Part Ordering Number System

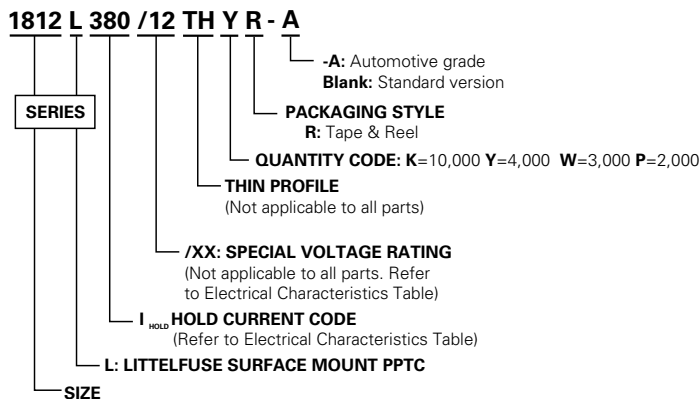

Packaging

| Part Number | Ordering Number | Halogen Free | I _{hold} (A) | I _{hold} Code | Voltage Option | Packaging Option | Quantity | Quantity & Packaging Code |
|-------------|-----------------|--------------|-----------------------|------------------------|----------------|------------------|----------|---------------------------|
| 1812L010 | 1812L010DR | Yes | 0.10 | 010 | | Tape and Reel | 1500 | DR |
| 1812L010/60 | 1812L010/60DR | Yes | 0.10 | 010 | /60 | | 1500 | DR |
| 1812L014 | 1812L014DR | Yes | 0.14 | 014 | | | 1500 | DR |
| 1812L020 | 1812L020PR | Yes | 0.20 | 020 | | | 2000 | PR |
| 1812L020/60 | 1812L020/60DR | Yes | 0.20 | 020 | /60 | | 1500 | DR |
| 1812L035/30 | 1812L035/30DR | Yes | 0.35 | 035 | /30 | | 1500 | DR |
| 1812L035/60 | 1812L035/60 | Yes | 0.35 | 035 | /60 | | 1000 | MR |
| 1812L050 | 1812L050PR | Yes | 0.50 | 050 | | | 2000 | PR |
| 1812L050/30 | 1812L050/30PR | Yes | 0.50 | 050 | /30 | | 2000 | PR |
| 1812L050/60 | 1812L050/60 | Yes | 0.50 | 050 | /60 | | 1000 | MR |
| 1812L075 | 1812L075PR | Yes | 0.75 | 075 | | | 2000 | PR |
| 1812L75/24 | 1812L075/24DR | Yes | 0.75 | 075 | /24 | | 1500 | DR |
| 1812L75/33 | 1812L075/33DR | Yes | 0.75 | 075 | /33 | | 1500 | DR |
| 1812L110 | 1812L110PR | Yes | 1.10 | 110 | | | 2000 | PR |
| 1812L110/16 | 1812L110/16DR | Yes | 1.10 | 110 | /16 | | 1500 | DR |
| 1812L110/24 | 1812L110/24DR | Yes | 1.10 | 110 | /24 | | 1500 | DR |
| 1812L110/33 | 1812L110/33MR | Yes | 1.10 | 110 | /33 | | 1000 | MR |
| 1812L125/6 | 1812L125/6PR | Yes | 1.25 | 125 | /6 | | 2000 | PR |
| 1812L125/16 | 1812L125/16DR | Yes | 1.25 | 125 | /16 | | 1500 | DR |
| 1812L150 | 1812L150ZR | Yes | 1.50 | 150 | | | 2000 | ZR |
| 1812L150/12 | 1812L150/12DR | Yes | 1.50 | 150 | /12 | | 1500 | DR |
| 1812L150/16 | 1812L150/16DR | Yes | 1.50 | 150 | /16 | | 1500 | DR |
| 1812L150/24 | 1812L150/24MR | Yes | 1.50 | 150 | /24 | | 1000 | MR |
| 1812L160 | 1812L160PR | Yes | 1.60 | 160 | | | 2000 | PR |
| 1812L160/12 | 1812L160/12DR | Yes | 1.60 | 160 | /12 | | 1500 | DR |
| 1812L200TH | 1812L200THPR | Yes | 2.00 | 200 | | | 2000 | PR |
| 1812L200/12 | 1812L200/12DR | Yes | 2.00 | 200 | /12 | | 1500 | DR |
| 1812L200/16 | 1812L200/16DR | Yes | 2.00 | 200 | | | 1500 | DR |
| 1812L260TH | 1812L260THDR | Yes | 2.60 | 260 | | | 1500 | DR |
| 1812L260/12 | 1812L260/12MR | Yes | 2.60 | 260 | /12 | | 1000 | MR |
| 1812L260/16 | 1812L260/16MR | Yes | 2.60 | 260 | | | 1000 | MR |
| 1812L300 | 1812L300MR | Yes | 3.00 | 300 | | | 1000 | MR |

WARNING

- Users shall independently assess the suitability of these devices for each of their applications
- Operation of these devices beyond the stated maximum ratings could result in damage to the devices and lead to electrical arcing and/or fire
- These devices are intended to protect against the effects of temporary over-current or over-temperature conditions and are not intended to perform as protective devices where such conditions are expected to be repetitive or prolonged in duration
- Exposure to silicon-based oils, solvents, electrolytes, acids, and similar materials can adversely affect the performance of these PPTC devices
- These devices undergo thermal expansion under fault conditions, and thus shall be provided with adequate space and be protected against mechanical stresses
- Circuits with inductance may generate a voltage (L di/dt) above the rated voltage of the PPTC device.

Tape and Reel Specifications

TAPE SPECIFICATIONS: EIA-481-1 (mm)

| | 1812L020 1812L035/30 1812L050 1812L075 1812L110 1812L125/6 1812L150 1812L160 1812L200 | 1812L010 1812L010/60 1812L014 1812L020/60 1812L050/30 1812L075/24 1812L075/33 1812L110/16 1812L110/24 1812L125/16 1812L150/12 1812L150/16 1812L160/12 1812L200/12 1812L200/16 1812L260 | 1812L035/60 1812L050/60 1812L110/33 1812L150/24 1812L260/12 1812L260/16 1812L300 |
|----------------------|---|---|--|
| W | 12.00 ± 0.30 | 12.00 ± 0.30 | 12.00 ± 0.30 |
| F | 5.50 ± 0.05 | 5.50 ± 0.05 | 5.50 ± 0.05 |
| E₁ | 1.75 ± 0.10 | 1.75 ± 0.10 | 1.75 ± 0.10 |
| D₀ | 1.55 ± 0.10 | 1.55±/-0.05 | 1.55 ± 0.05 |
| D₁ | 1.55 (min) | 1.50±/-0.10 | 1.50 (MIN) |
| P₀ | 4.00 ± 0.10 | 4.00 ± 0.10 | 4.00 ± 0.08 |
| P₁ | 8.00 ± 0.10 | 8.00 ± 0.10 | 8.00 ± 0.10 |
| P₂ | 2.00 ± 0.05 | 2.00 ± 0.05 | 2.00 ± 0.05 |
| A₀ | 3.58 ± 0.10 | 3.50 ± 0.10 | 3.58 ± 0.10 |
| B₀ | 4.93 ± 0.10 | 4.85± 0.10 | 4.93 ± 0.10 |
| T | 0.25 ± 0.10 | 0.25 ± 0.10 | 0.25 ± 0.10 |
| K₀ | 0.87± 0.06 | 1.25 ± 0.10 | 2.10 ± 0.10 |
| Leader min. | 390 | 390 | 390 |
| Trailer min. | 160 | 160 | 160 |

**REEL DIMENSIONS:
EIA-481-1 (mm)**

| | |
|----------|-------------|
| C | Ø178 ± 1.0 |
| D | Ø60.2 ± 0.5 |
| H | 16.0 ± 0.5 |
| W | 13.2 ± 1.5 |

Tape and Reel Diagram

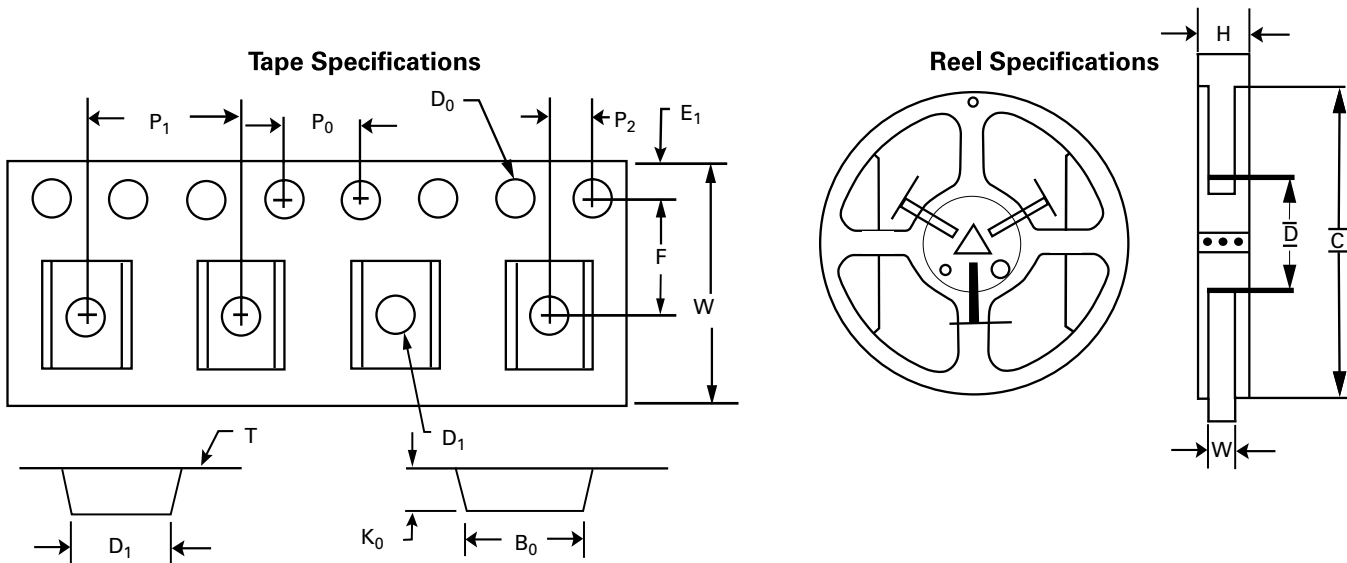

Disclaimer Notice - Information furnished is believed to be accurate and reliable. However, users should independently evaluate the suitability of and test each product selected for their own applications. Littelfuse products are not designed for, and may not be used in, all applications. Read complete Disclaimer Notice at www.littelfuse.com/disclaimer-electronics.

单击下面可查看定价，库存，交付和生命周期等信息

[>>Littelfuse\(美国力特\)](#)