

# SM580B

Surface Mount Schottky Barrier Rectifiers  
Reverse Voltage 80V Forward Current 5.0A

## 1. FEATURES

- We declare that the material of product compliance with RoHS requirements and Halogen Free.
- Plastic package has Underwriters Laboratory Flammability Classification 94V-0.
- Low power loss,high efficiency.
- For use in low voltage high frequency inverters,free wheeling, and polarity protection applications.
- High temperature soldering guaranteed:260°C/10 seconds.
- Weight: 0.088g

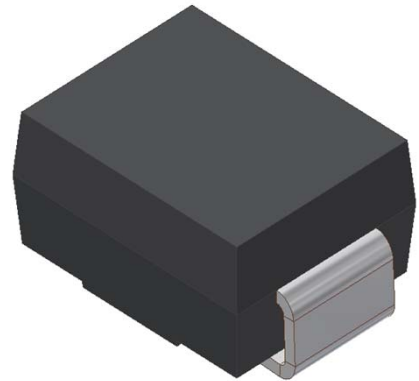

## 2. DEVICE MARKING AND ORDERING INFORMATION

Device	Marking	Shipping
SM580B	S58	4000/Tape&Reel

## 3. MAXIMUM RATINGS(Ta = 25°C)

Parameter	0	Symbol	Limits	Unit
Maximum repetitive peak reverse voltage		VRRM	80	V
Maximum RMS voltage		VRMS	56	V
Maximum DC blocking voltage		VDC	80	V
Maximum average forward rectified current 0.375" (9.5mm) lead length at TC = 75°C		IF(AV)	5	A
Peak forward surge current 8.3ms single half sine-wave superimposed on rated load (JEDEC Method)		IFSM	120	A
Typical thermal resistance (Note 1)		RθJA	160	°C/W
		RθJC	50	
Operating junction and storage temperature range		TJ, TSTG	-50 ~+150	°C

## 4. ELECTRICAL CHARACTERISTICS (Ta= 25°C)

Characteristic	Symbol	Min.	Typ.	Max.	Unit
Maximum instantaneous forward voltage at 5.0A	VF	-	-	0.85	V
Maximum DC reverse current TA = 25°C at rated DC blocking voltage TJ = 100°C	IR	-	-	0.5 10	mA
Typical junction capacitance at 4.0V, 1MHz	CJ	-	250	-	PF

1. 8.0mm<sup>2</sup> (.013mm thick) land areas

### 5. ELECTRICAL CHARACTERISTICS CURVES

Fig. 1 - Forward Current Derating Curve

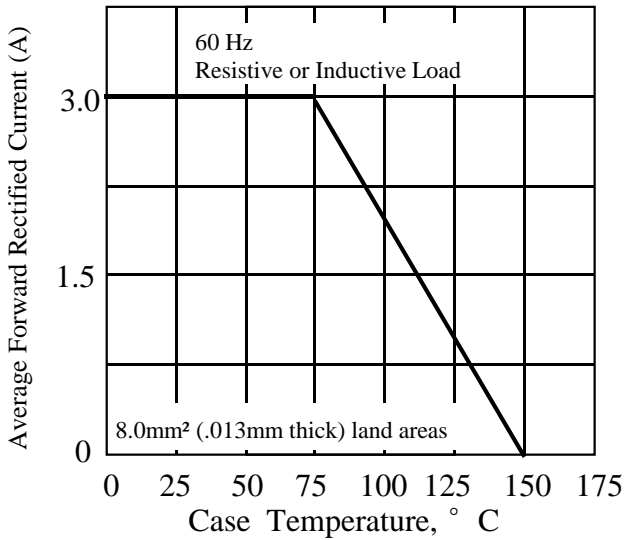

Fig. 2 - Maximum Non-repetitive Peak Forward Surge Current

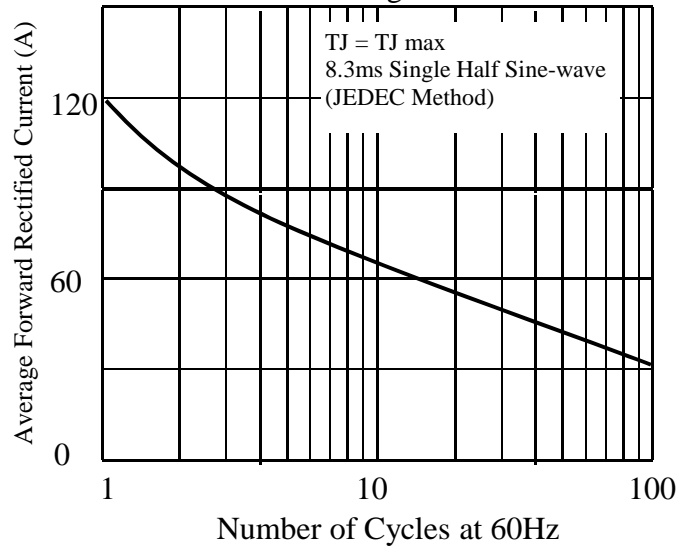

Fig. 3. - Typical Instantaneous Forward Characteristics

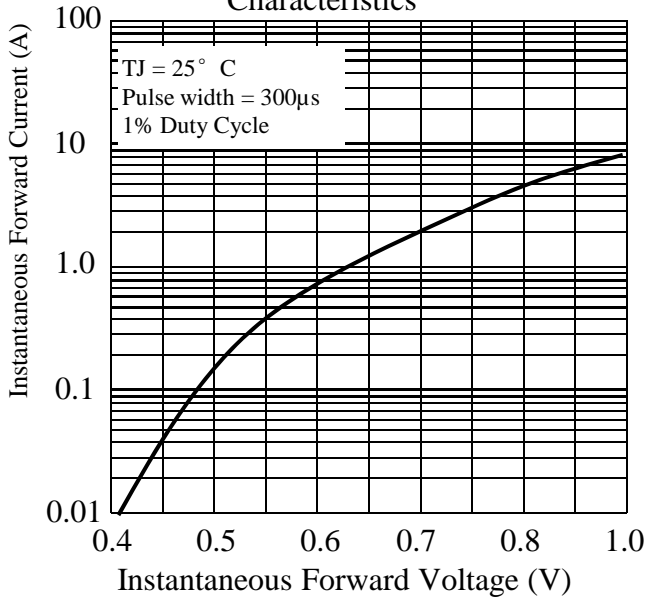

Fig. 4. - Typical Reverse Characteristics

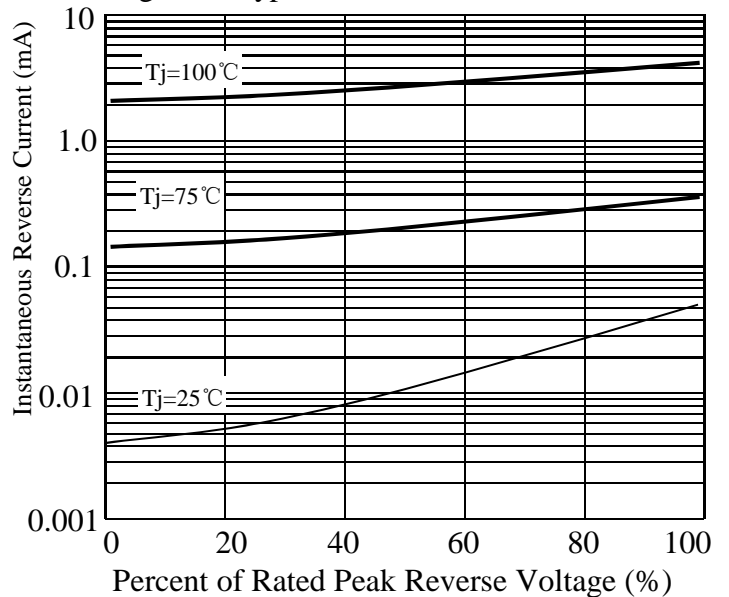
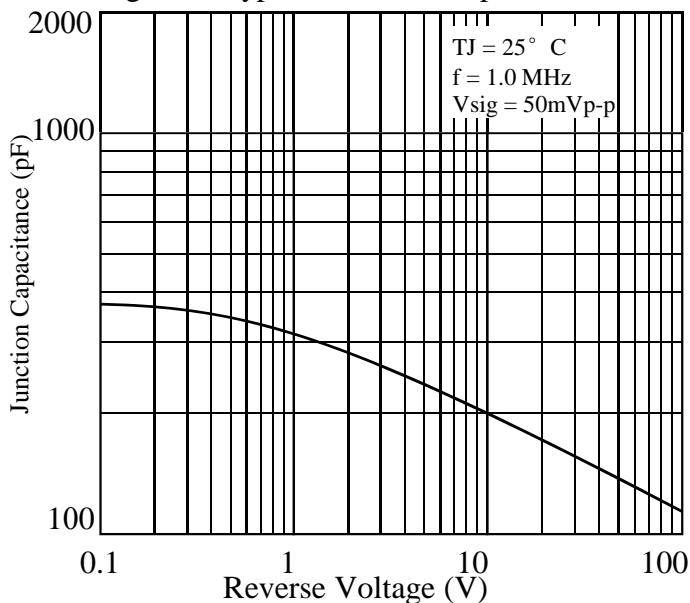
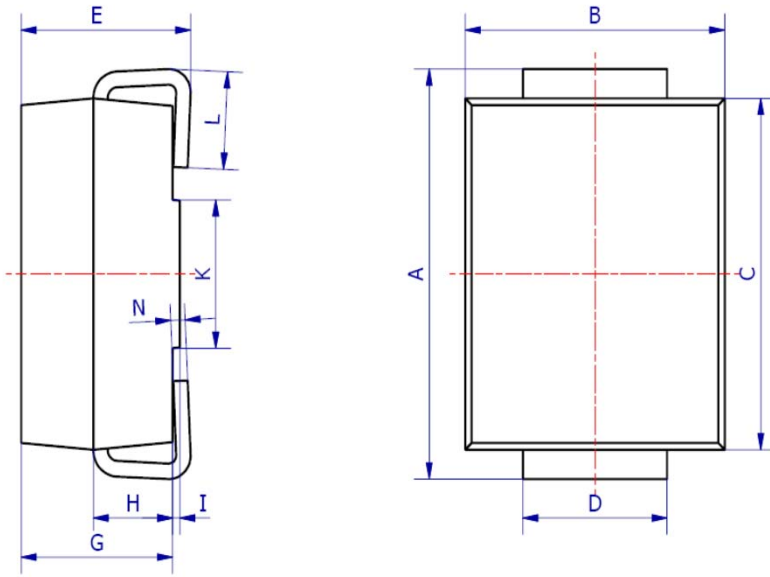

Fig. 5. - Typical Junction Capacitance



## 6. OUTLINE AND DIMENSIONS



SMB			
DIM	Min	Max	Typ.
A	5.00	5.45	5.25
B	3.20	4.00	3.60
C	4.30	4.70	4.50
D	1.80	2.20	2.00
E	2.20	2.50	2.35
G	1.90	2.30	2.10
H	0.95	1.25	1.10
I	0.05	0.15	0.10
K	1.70	2.10	1.90
L	0.90	1.60	1.30
N	0.10	0.30	0.20
All Dimensions in mm			

## 7. SOLDERING FOOTPRINT

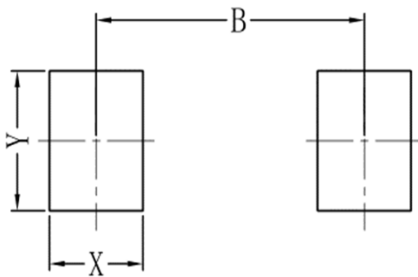

SMB	
DIM	(mm)
X	1.60
Y	2.20
B	4.60

单击下面可查看定价，库存，交付和生命周期等信息

[>>LRC\(乐山无线电\)](#)