

SM320BF thru SM3100BF

Schottky Barrier Rectifiers

Reverse Voltage 20 to 100V Forward Current 3.0A

FEATURES

- * Plastic package has Underwriters Laboratory Flammability Classification 94V-0
- * Low power loss, high efficiency
- * For use in low voltage high frequency inverters, free wheeling, and polarity protection applications
- * Guardring for over voltage protection
- * High temperature soldering guaranteed:
260°C/10 seconds at terminals

ESD Rating:

- * Human Body Model 3A
- * Machine Model C

Mechanical Data

Case: JEDEC SMB-FL

molded plastic over glass die

Terminals: Plated leads, solderable per MIL-STD-750, Method 2026

Polarity: Color band denotes cathode end

Mounting Position: Any

Weight: 0.066 g

Handling precaution: None

Electrical Characteristic

1. Maximum Ratings & Thermal Characteristics Ratings at 25°C ambient temperature unless otherwise specified.

Parameter Symbol	symbol	SM320BF	SM330BF	SM340BF	SM350BF	SM360BF	SM380BF	SM3100BF	Unit
device marking code		S32	S33	S34	S35	S36	S38	S310	
Maximum repetitive peak reverse voltage	V_{RRM}	20	30	40	50	60	80	100	V
Maximum RSM voltage	V_{RSM}	14	21	28	35	42	56	70	V
Maximum DC blocking voltage	V_{DC}	20	30	40	50	60	80	100	V
Maximum average forward rectified current lead length at TC = 75°C	$I_F(AV)$	3.0							A
Peak forward surge current 8.3ms single half sine-wave superimposed on rated load (JEDEC Method)	I_{FSM}	80							A
Typical thermal resistance (Note1)	R θ JA R θ JC	135 25							°C/W
Operating junction and storage temperature range	T _J , T _{STG}	-40 to +150							°C

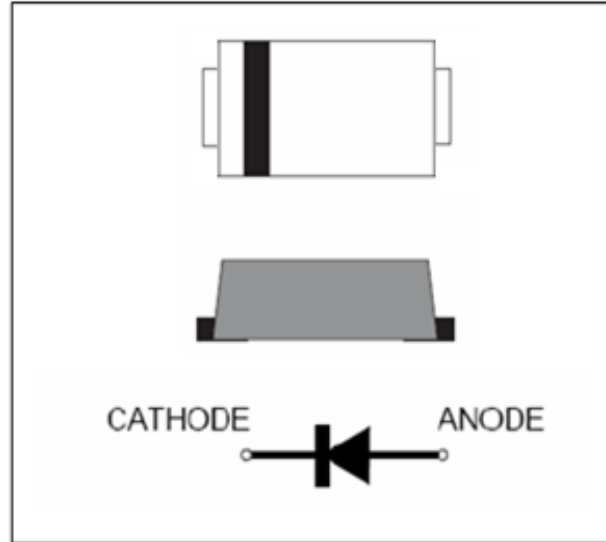

we declare that the material of product is halogen free (green epoxy compound).

Electrical Characteristics Ratings at 25°C ambient temperature unless otherwise specified.

Parameter Symbol	symbol	SM320BF	SM330BF	SM340BF	SM350BF	SM360BF	SM380BF	SM3100BF	Unit	
Maximum instantaneous forward voltage at 3.0A	V_F	0.50			0.70		0.85		V	
Maximum DC reverse current TA = 25°C at rated DC blocking voltage Tj = 100°C	IR	0.5				10.0				mA
Typical junction capacitance at 4.0V, 1MHz	CJ	110							PF	

NOTES:

1.8.0mm² (.013mm thick) land areas

SM320BF thru SM3100BF

2. Ratings and Characteristic Curves (TA = 25°C unless otherwise noted)

Fig. 1 - Forward Current Derating Curve

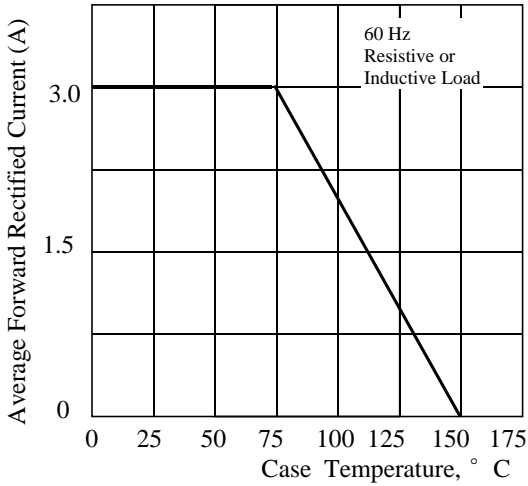

Fig. 2 - Maximum Non-repetitive Peak Forward Surge Current

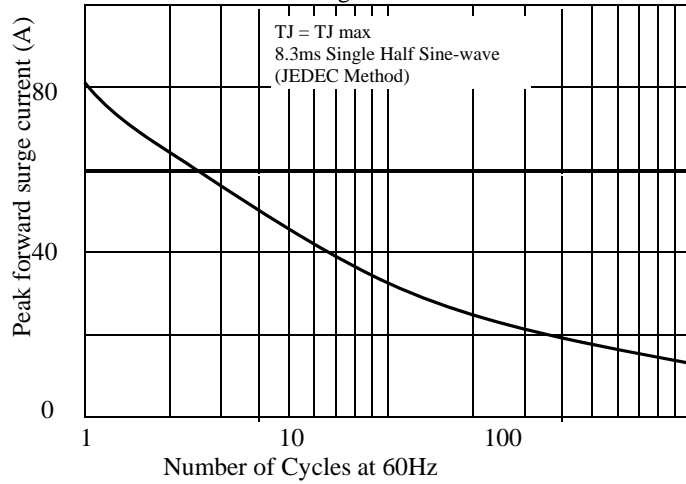

Fig 3. - Typical Instantaneous Forward Characteristics

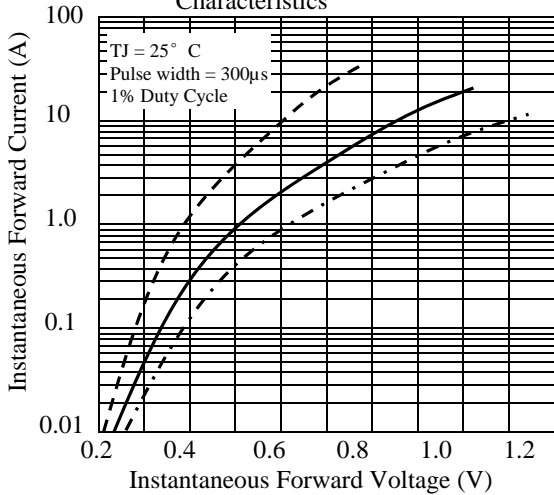

Fig 4. - Typical Reverse Characteristics

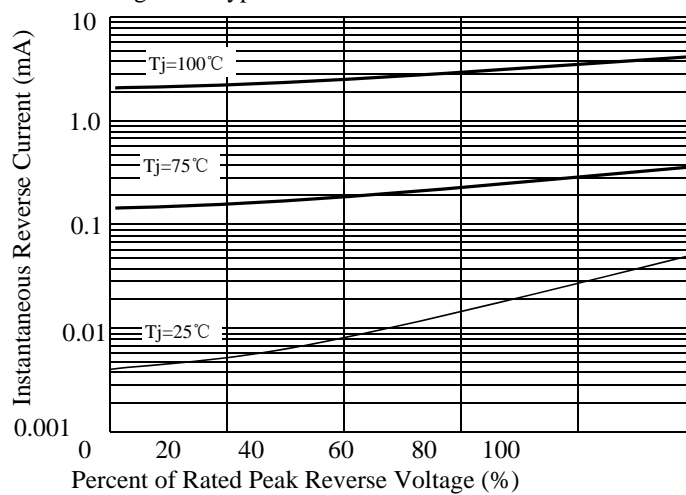

Fig 5. - typical transient thermal impedance

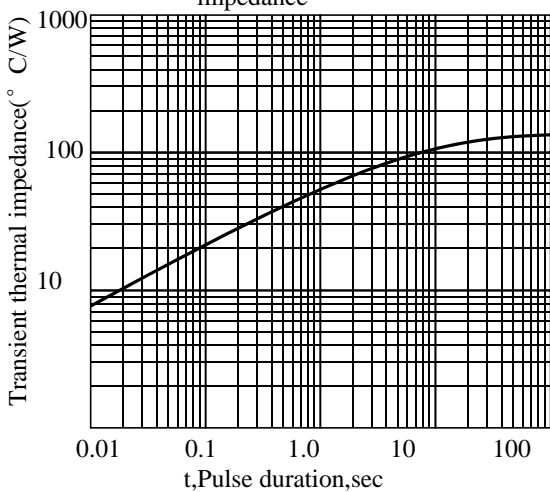
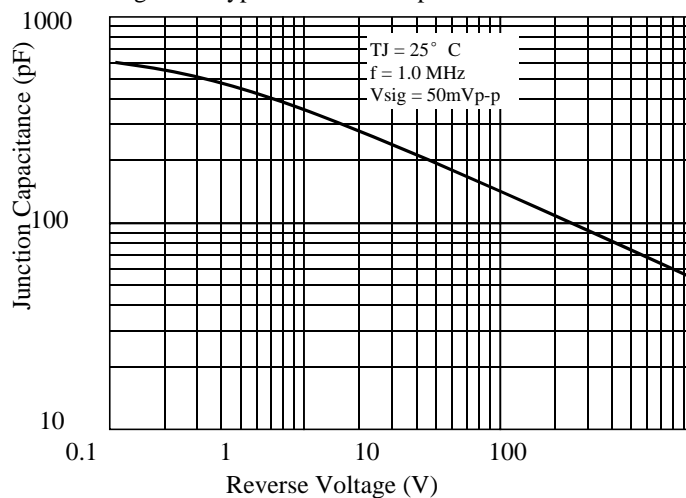

Fig 6. - Typical Junction Capacitance



SM320BF thru SM3100BF

3. dimension:

SMB-FL

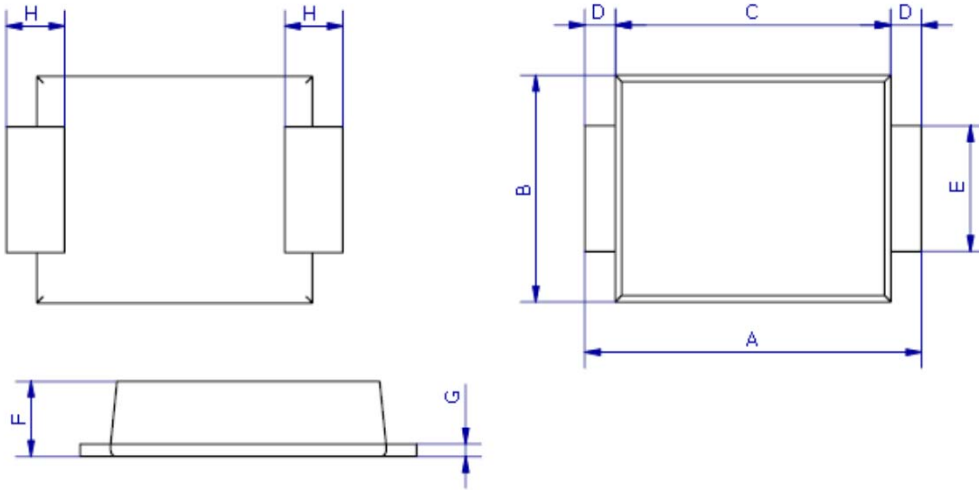

DIM	MILLIMETERS		INCHES	
	MIN	MAX	MIN	MAX
A	5.3	5.7	0.209	0.224
B	3.4	3.8	0.134	0.150
C	4.3	4.7	0.169	0.185
D	0.45Typ		0.018Typ	
E	1.9	2.1	0.0748	0.08268
F	1.05	1.40	0.04134	0.05512
G	0.2	0.3	0.00591	0.00984
H	0.95Typ		0.037Typ	

Mounting Pad Layout

--- SMB-FL

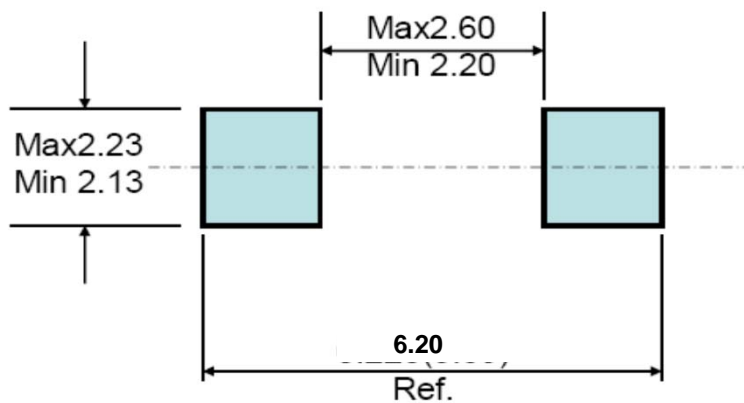

SM320BF thru SM3100BF

4. Update Record

版次	更新记录	更新作者	更新日期
1	第一版	周杰	2014. 04. 30
2	增加ESD等级	周杰	2016. 04. 05

单击下面可查看定价，库存，交付和生命周期等信息

[>>LRC\(乐山无线电\)](#)

[>>点击查看相关商品](#)