

THIS DRAWING IS UNPUBLISHED. RELEASED FOR PUBLICATION 2007
 © COPYRIGHT 2007 BY - ALL RIGHTS RESERVED.

LOC	DIST	REVISIONS			
P	LTR	DESCRIPTION	DATE	DWN	APVD
J		A	INITIAL RELEASED	22JUL2017	N.W C.W

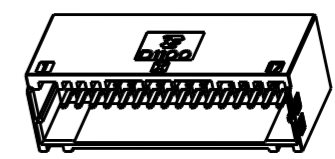

SCALE 1:1

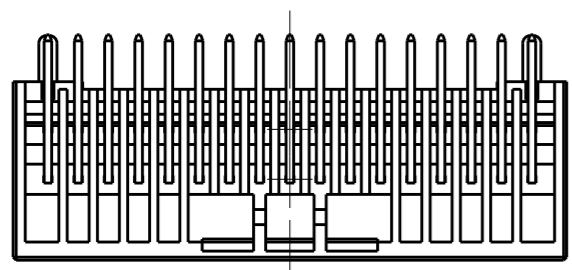
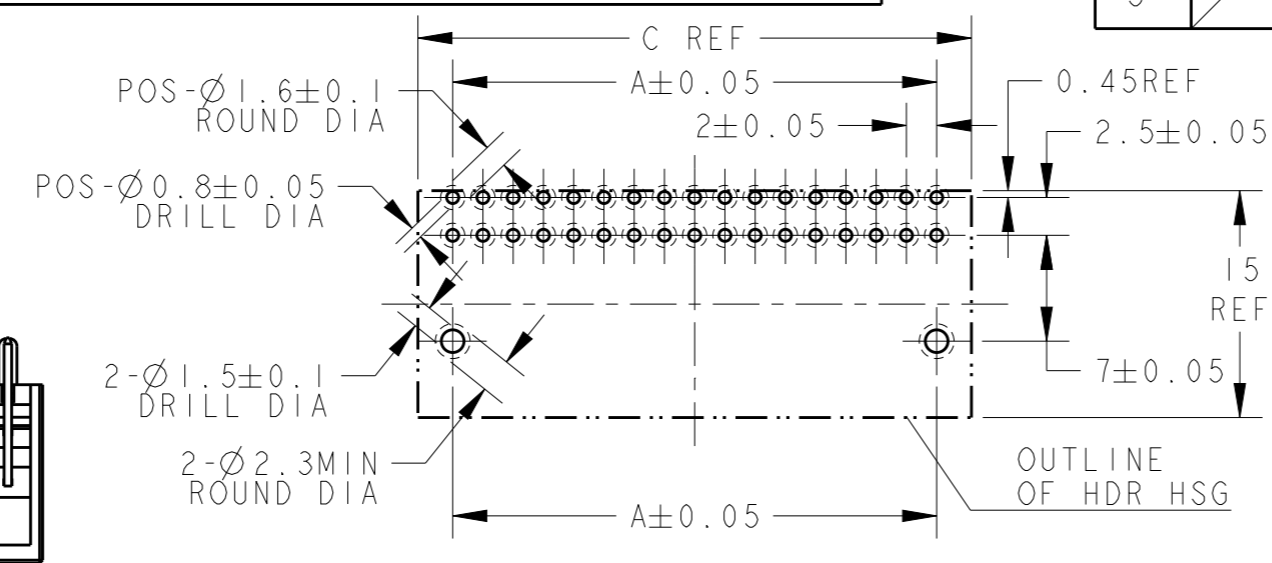
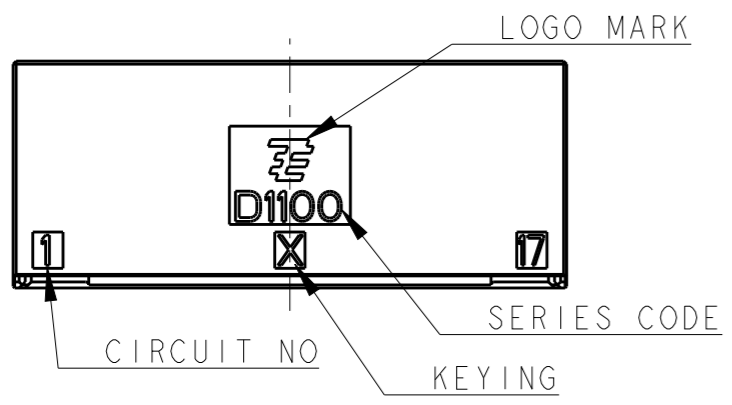

RECOMMEND PC BOARD HOLE PATTERN : CONNECTOR MOUNT SIDE (NOT ACCUMULATE TOLERANCE)
 PC BOARD THICKNESS : 1.0~1.6±0.1mm.

1. MATERIAL: HOUSING: GLASS FILLED THERMO PLASTIC POLYESTER(94V-0), COLOR: BLACK
 CONTACT: COPPER ALLOY
 RETENTION LEG: PRE-TIN COPPER ALLOY

2. FINISH(ALL OVER): NICKEL PLATING 1.27μmMIN
 3. FINISH(CONTACT AREA): TIN PLATING 1.0μmMIN AFTER 2
 4. FINISH(CONTACT TAIL): TIN PLATING 2μmMIN AFTER 2
 5. THE SHAPE, SIZE AND POSITION OF THE CHARACTER SHOW THE OUTLINE. THEY DON'T SHOW DETAILS.

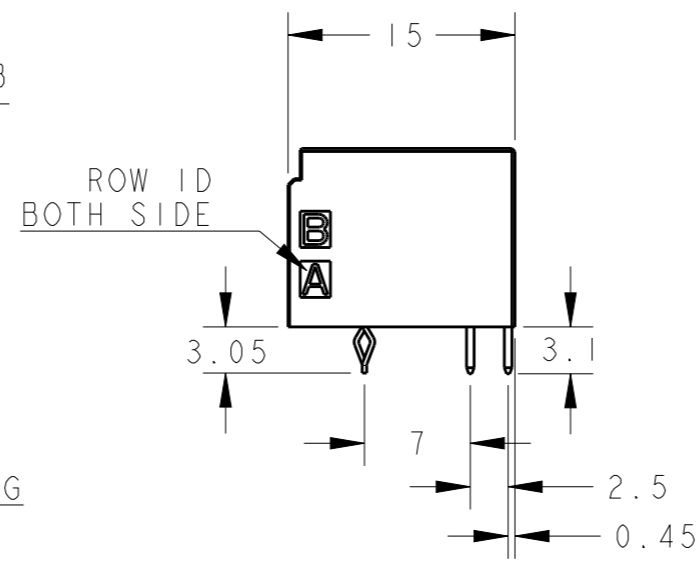
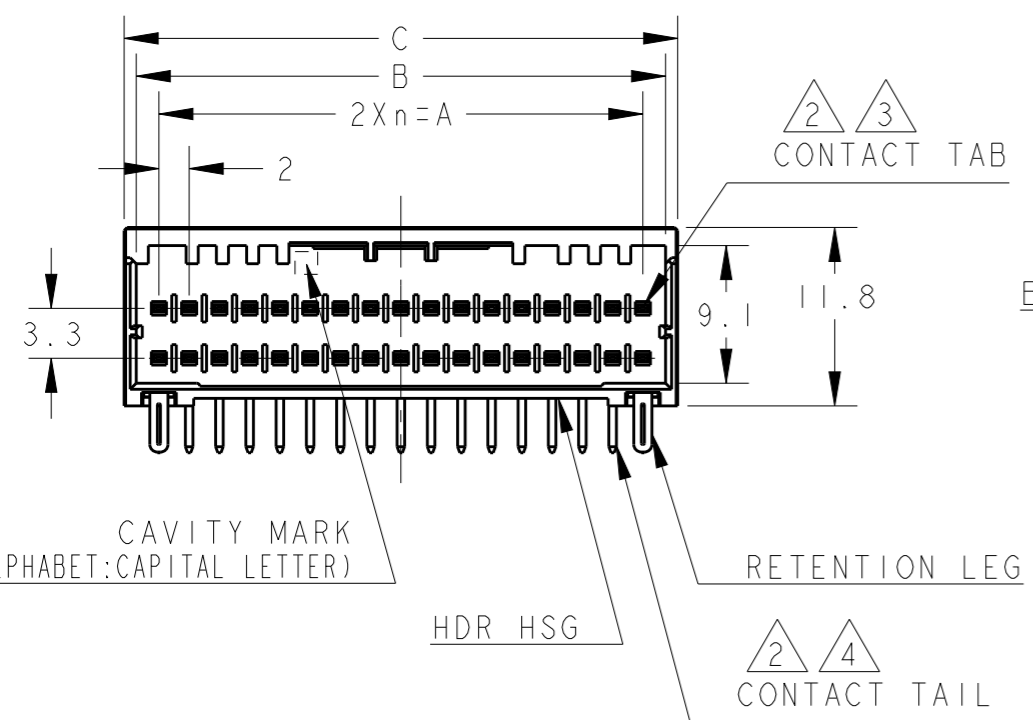

POS	KEY	n	A	B	C	PART NO
40	X	19	38.0	41.0	42.6	1-2271888-0
34	X	16	32.0	35.0	36.6	1-2271888-7
30	X	14	28.0	31.0	32.6	1-2271888-5
28	X	13	26.0	29.0	30.6	1-2271888-4
26	X	12	24.0	27.0	28.6	1-2271888-3

34POS(X-KEY): 1-2271888-7

THIS DRAWING IS A CONTROLLED DOCUMENT.		DWN 26JUN2017 Ning Wang		TE Connectivity	
DIMENSIONS: mm		CHK 26JUN2017 Chris Wang			
TOLERANCES UNLESS OTHERWISE SPECIFIED: ±0.3, ±5°		APVD 26JUN2017 Chris Wang		NAME DYNAMIC D1100D 2.0mmPITCH HDR ASSY, H-TYPE 22-40POS	
0 PLC ± 1 PLC ± 2 PLC ± 3 PLC ± 4 PLC ± ANGLES ±		PRODUCT SPEC 108-78298		DRAWING NO A300779	
MATERIAL		APPLICATION SPEC 114-5377		RESTRICTED TO	
FINISH		WEIGHT		CAGE CODE G-2271888	
Customer Drawing		SCALE 1:1		SHEET 1 OF 2	

THIS DRAWING IS UNPUBLISHED.

RELEASED FOR PUBLICATION

2007

© COPYRIGHT 2007 BY -

ALL RIGHTS RESERVED.

LOC
J

DIST

REVISIONS

P	LTR	DESCRIPTION	DATE	DWN	APVD
		SEE SHEET 1 OF 2			

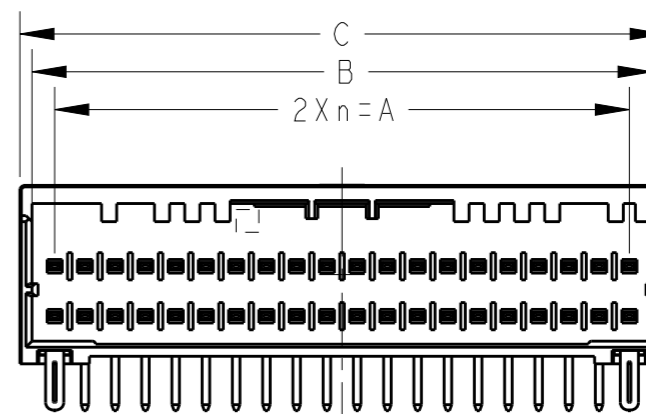
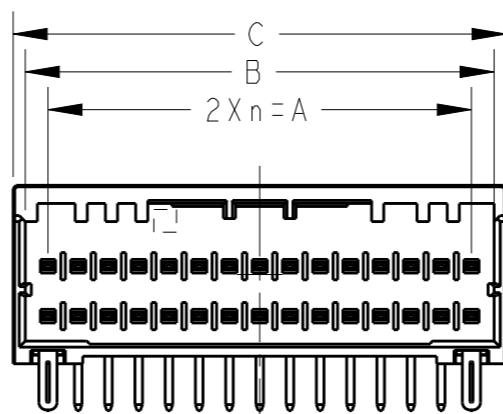
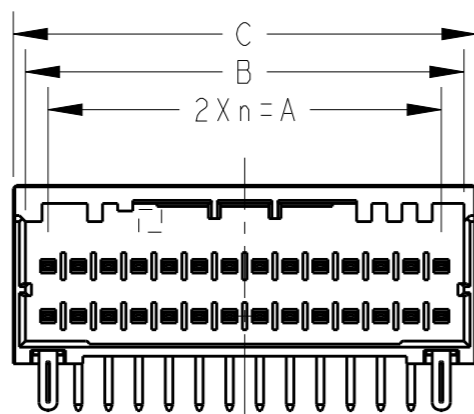
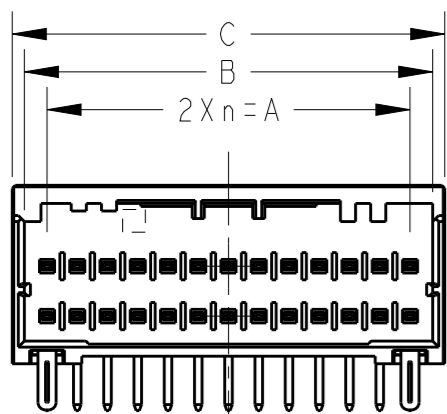
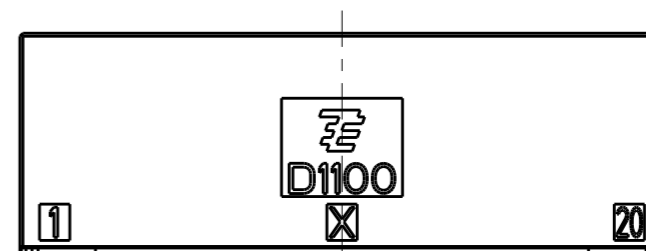
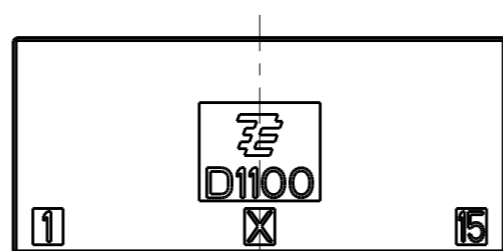
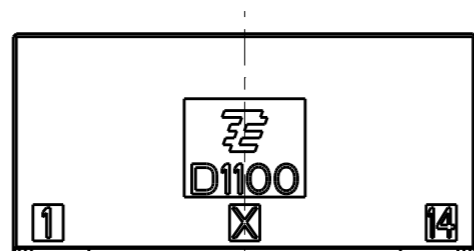
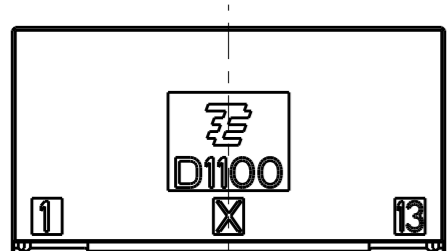
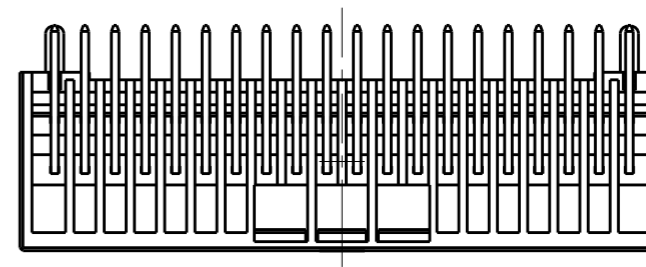
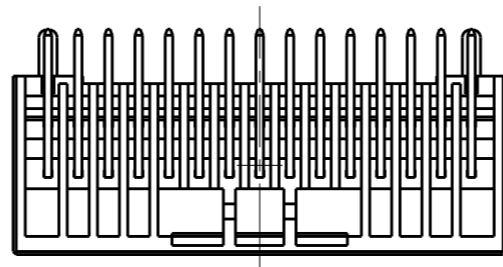
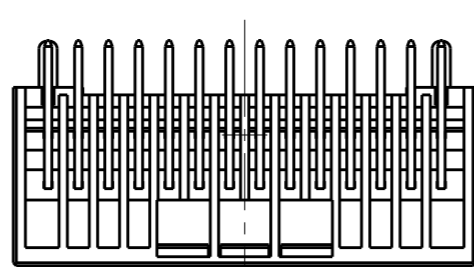
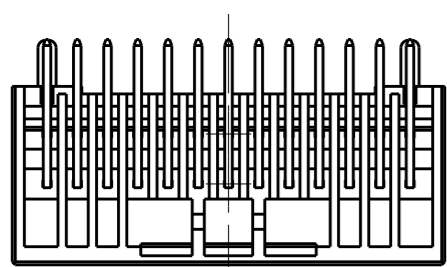

26POS(X-KEY): 1-2271888-3

28POS(X-KEY): 1-2271888-4

30POS(X-KEY): 1-2271888-5

40POS(X-KEY): 1-2271888-0

THIS DRAWING IS A CONTROLLED DOCUMENT.

DIMENSIONS:
mm

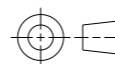

TOLERANCES UNLESS OTHERWISE SPECIFIED:

- 0 PLC ±-
- 1 PLC ±-
- 2 PLC ±-
- 3 PLC ±-
- 4 PLC ±-
- ANGLES ±-
- FINISH -

MATERIAL

DWN 26JUL2017

Ning Wang

CHK 26JUL2017

Chris Wang

APVD 26JUL2017

Chris Wang

PRODUCT SPEC

108-78298

APPLICATION SPEC

114-5377

WEIGHT

-

Customer Drawing



TE Connectivity

NAME
DYNAMIC D1100D 2.0mmPITCH
HDR ASSY, H-TYPE
22-40POS

SIZE	CAGE CODE	DRAWING NO	RESTRICTED TO
A3	00779	C-2271888	-

SCALE	SHEET	OF	REV
2:1	2	2	A

单击下面可查看定价，库存，交付和生命周期等信息

[>>TE Connectivity\(泰科\)](#)