

LMBR2150FT1G

S-LMBR2150FT1G

Schottky Barrier Rectifiers

1. FEATURES

- Plastic package has Underwriters Laboratory Flammability Classification 94V-0.
- Low power loss,high efficiency.
- For use in low voltage high frequency inverters,free wheeling,and polarity protection applications.
- Guardring for over voltage protection.
- High temperature soldering guaranteed:260°C/10 seconds at terminals.
- We declare that the material of product compliance with RoHS requirements and Halogen Free.
- S- prefix for automotive and other applications requiring unique site and control change requirements; AEC-Q101 qualified and PPAP capable.

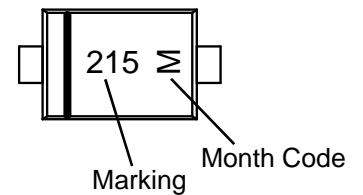
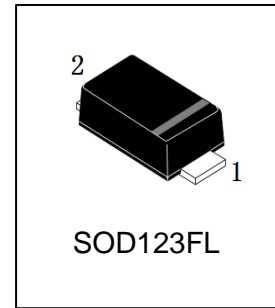

2. DEVICE MARKING AND ORDERING INFORMATION

Device	Marking	Shipping
LMBR2150FT1G	215	3000/Tape&Reel
S-LMBR2150FT1G	215	3000/Tape&Reel

3. MAXIMUM RATINGS(Ta = 25°C)

Parameter	Symbol	Limits	Unit
Maximum repetitive peak reverse voltage	VRRM	150	V
Maximum RMS voltage	VRMS	105	V
Maximum DC blocking voltage	VDC	150	V
Maximum average forward rectified current at TC = 75°C	IF(AV)	2	A
Peak forward surge current 8.3ms single half sine-wave superimposed on rated load (JEDEC Method)	IFSM	50	A
Power Dissipation	PD	400	mW
Typical thermal resistance (Note 1)	RθJA	170	°C/W
	RθJL	40	
Operating junction temperature range	TJ	-40 ~ +150	°C
storage temperature range	TSTG	-40 ~ +150	°C

1. 8.0mm² (.013mm thick) land areas

4. ELECTRICAL CHARACTERISTICS (Ta= 25°C)

Characteristic	Symbol	Min	Typ.	Max	Unit
Maximum instantaneous forward voltage at 2.0A	VF	-	-	0.9	V
Maximum DC reverse current at rated DC blocking voltage TA = 25°C Tj = 100°C	IR	-	-	5	uA
		-	-	20	mA
Typical junction capacitance at 4.0V, 1MHz	CJ	-	47	-	pF

5.ELECTRICAL CHARACTERISTICS CURVES

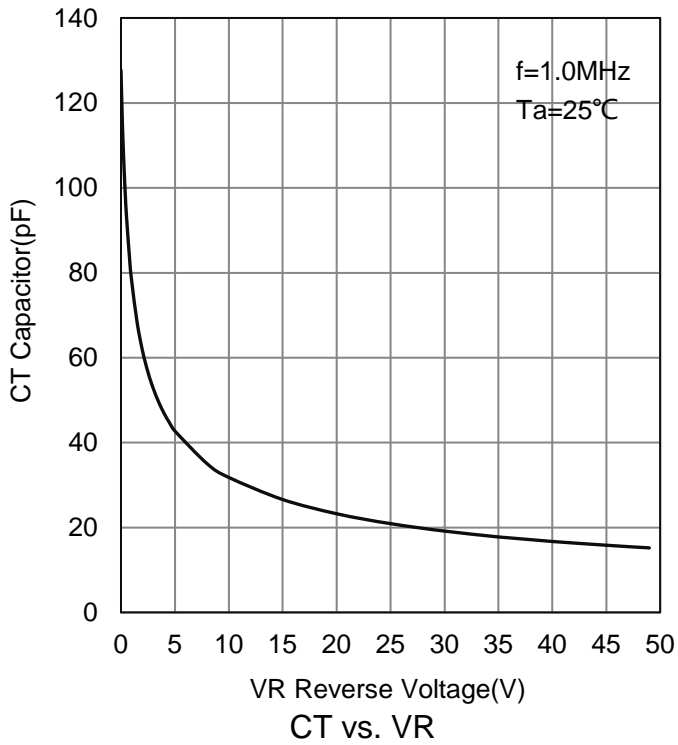
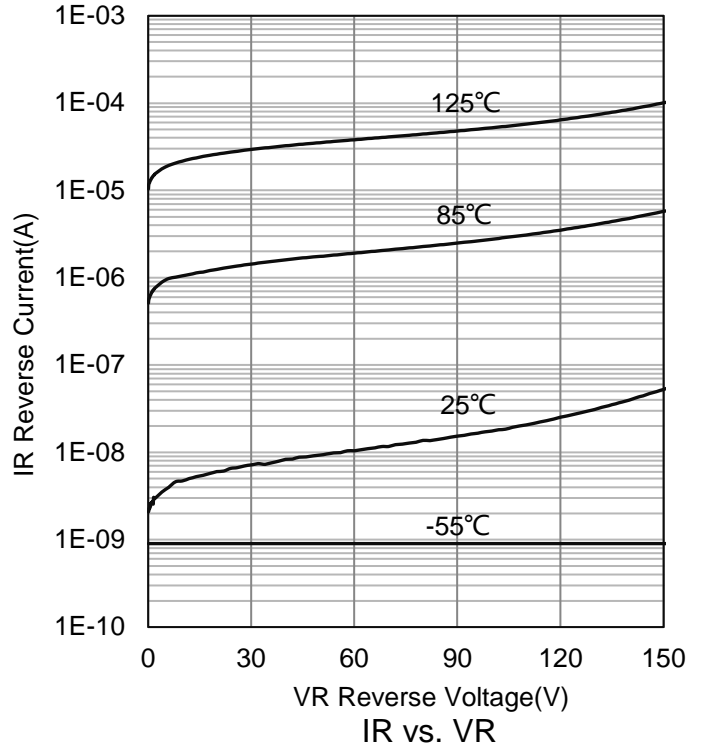
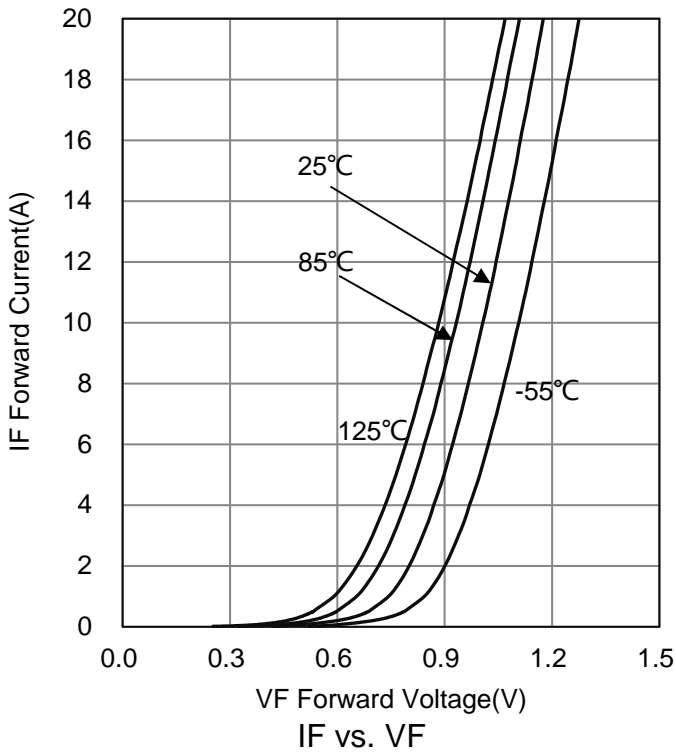

6.OUTLINE AND DIMENSIONS

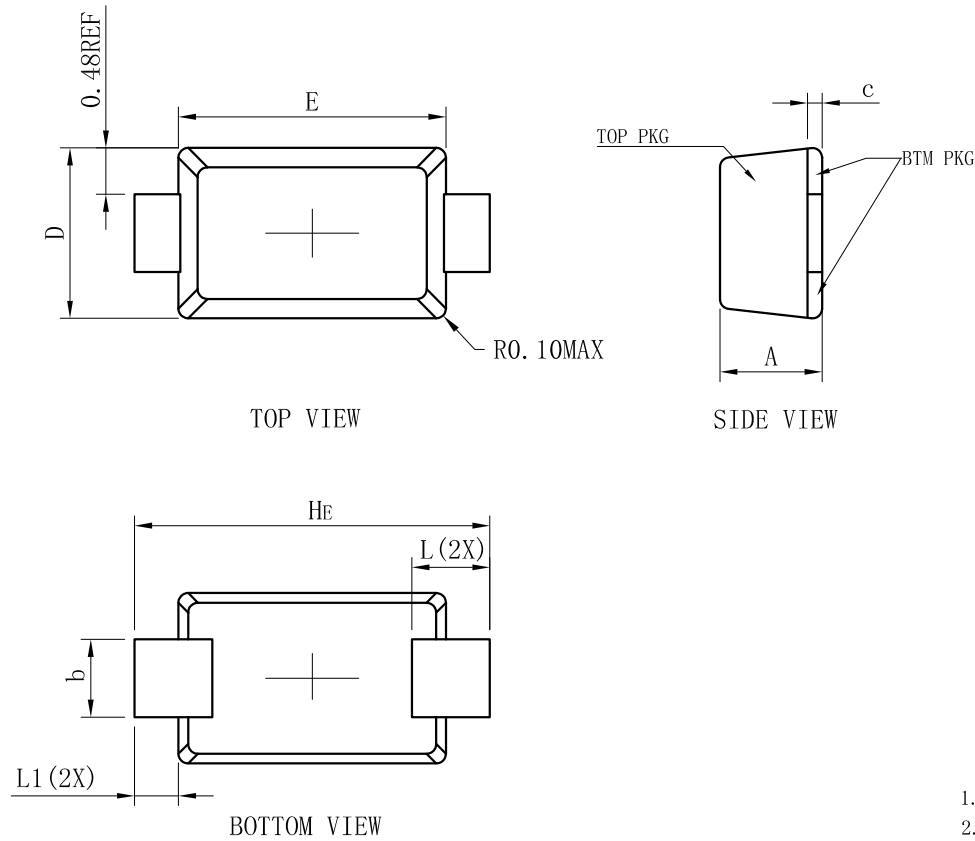

SOD123FL			
DIM	MIN	NOR	MAX
A	0.90	1.05	1.15
b	0.75	0.80	0.95
L	0.80REF.		
E	2.60	2.75	2.90
D	1.60	1.75	1.90
HE	3.50	3.65	3.80
c	0.12	0.17	0.22
L1	0.45REF.		
All Dimensions in mm			

GENERAL NOTES

- 1.Top package surface finish Ra0.4±0.2um
- 2.Bottom package surface finish Ra0.7±0.2um
- 3.Side package surface finish Ra0.4±0.2um

7.SOLDERING FOOTPRINT

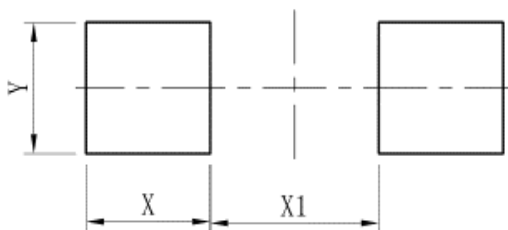

DIM	(mm)
X	1.20
Y	1.10
X1	2.00

单击下面可查看定价，库存，交付和生命周期等信息

[>>LRC\(乐山无线电\)](#)