

To : SKST

Specification number:EQM08-1KC-E167K04

Date of issue: 4 July, 2016

## Multilayer ceramic Chip capacitor specification

Product Part No

CM02X5R104K06AH

(Recipient stamp column)

Please send back with recipient stamp or signature here.

This specification would be invalidated unless sent back within a year after issue date of this specification.

**RoHS Compliant**

Kyocera Corporation  
Capacitor Division



Contents

1.Application	8.Mechanical Strength
2.Nomenclature	9.Packaging material
3.Structure	10.Packaging style
4.Electrical properties	11.Label and location
5.Reliability	12.Production Site
6.Heat Resistance	13.Precautions
7.Solderability	14.Revision History

## 1. Application

This specification is applied to the multilayer ceramic Chip capacitor supplied from KYOCERA.

## 2. Nomenclature

(Ex)	<u>CM</u>	<u>02</u>	<u>X5R</u>	<u>104</u>	<u>K</u>	<u>06</u>	<u>A</u>	<u>H</u>
	(1)	(2)	(3)	(4)	(5)	(6)	(7)	(8)

( 01005size / X5R / 100,000pF ± 10% / 6.3V )

(1)Series CM Series

(2)Size

(3)Temperature Characteristics

(4)Nominal capacitance

(5)Tolerance

(6)Voltage

(7)Termination A:Nickel barrier / Tin

(8)Packaging type



3. Structure

(1) Size

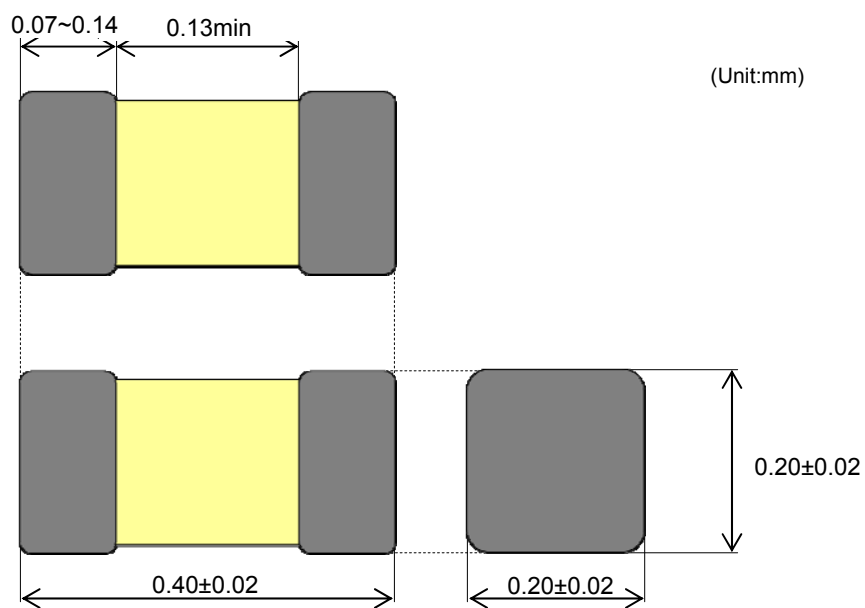

Fig.1 Dimension

(2) Appearance

No problem is observed under a microscope.

(3) Internal structure

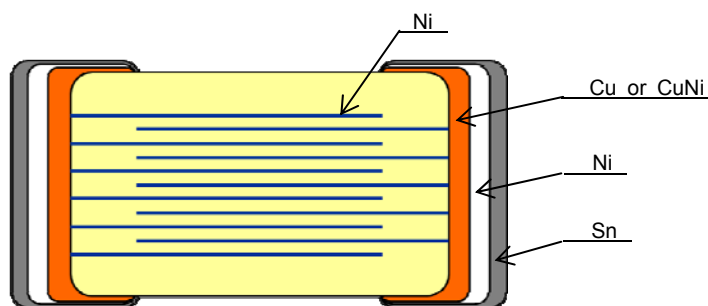
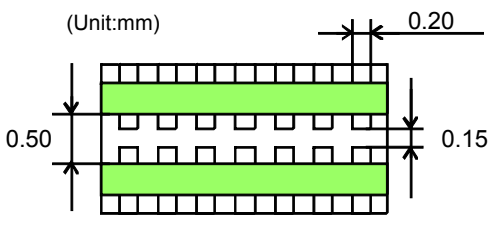

Fig.2 Internal structure

## 4. Electrical properties

No	Item	Test Conditions	Specifications	
1	Temperature characteristic of capacitance	<p>Keep the sample at 150+0/- 10 °C for 1 hour, leave the sample at room ambient for 24±2 hours.</p> <p>Frequency 1kHz±10%            Voltage 0.5±0.2Vrms            Temperature range -55°C to 85°C            Reference temperature 25°C</p>	No applied voltage	Change in capacitance: Within ±15%
2	Nominal capacitance and Tolerance	<p>Keep the sample at 150+0/- 10 °C for 1 hour, leave the sample at room ambient for 24±2 hours.</p> <p>Frequency 1kHz±10%            Voltage 1.0±0.2Vrms</p>	Within 100,000 pF ± 10%	
3	Dissipation factor (tanδ)	<p>Keep the sample at 150+0/- 10 °C for 1 hour, leave the sample at room ambient for 24±2 hours.</p> <p>Frequency 1kHz±10%            Voltage 1.0±0.2Vrms</p>	Within 12.5%	
4	Rated voltage	-	6.3V	
5	Insulation-resistance	<p>Measure after 6.3V is applied for 1 minute at room ambient.</p> <p>Charge and discharge current is 50mA or less.</p>	500MΩ·μF or over	
6	Dielectric Resistance	<p>15.75 V(2.5 times of rated voltage) is applied for 1 to 5seconds.</p> <p>Charge and discharge current is 50mA or less.</p>	Dielectric breakdown should not occur.	

5. Reliability

No	Item	Test Conditions	Specifications																
1	Temperature cycle	Keep the sample at 150+0/- 10 °C for 1 hour, leave the sample at room ambient for 24±2 hours. Measure the initial capacitance and dissipation factor  < Temperature cycle regulation > <table border="1" style="margin: 10px auto;"> <thead> <tr> <th>Stage</th> <th>Temperature</th> <th>Time</th> </tr> </thead> <tbody> <tr> <td>1</td> <td>Room temperature</td> <td>3min</td> </tr> <tr> <td>2</td> <td>Lowest operation temperature</td> <td>30min</td> </tr> <tr> <td>3</td> <td>Room temperature</td> <td>3min</td> </tr> <tr> <td>4</td> <td>Highest operation temperature</td> <td>30min</td> </tr> </tbody> </table> After 5 cycle, measure after 24±2 hours.  The charge and discharge current of the capacitor must not exceed 50mA for IR and withstanding voltage measurement.	Stage	Temperature	Time	1	Room temperature	3min	2	Lowest operation temperature	30min	3	Room temperature	3min	4	Highest operation temperature	30min	Appearance	No problem observed
			Stage	Temperature	Time														
			1	Room temperature	3min														
			2	Lowest operation temperature	30min														
			3	Room temperature	3min														
4	Highest operation temperature	30min																	
Capacitance Change	Within ±7.5% of the initial capacitance.																		
Dissipation Factor(tanδ)	Within 12.5%.																		
IR	500MΩ·μF or over																		
Dielectric Resistance	Dielectric breakdown should not occur.																		
		(Unit:mm) 																	
		Fig. 3. Substrate for temperature cycle test																	
2	Load humidity test	Apply the below mentioned test condition for 1 hour, then leave the sample at room ambient for 24±2 hours and measure the initial capacitance and dissipation factor.  After applying 6.3V for 500+12/-0 hours in pre-condition at 40±2°C, humidity 90% to 95%RH, allow parts to stabilize for 24±2 hours, at room temperature before measurement.  Charge and discharge current of the capacitor must not exceed 50mA for IR measurement.  Substrate for test is referred to Fig.3.	Appearance	No problem observed															
			Capacitance Change	Within ±12.5% of the initial capacitance															
			Dissipation Factor(tanδ)	Within 25.0%															
			IR	25MΩ·μF or over															

No	Item	Test Conditions	Specifications	
3	High-temperature with loading	<p>Apply the below mentioned test condition for 1 hour, then leave the sample at room ambient for 24±2 hours and measure the initial capacitance and dissipation factor.</p> <p>After applying 8.19V(1.3 times of rated voltage) for 1000+12/-0 hours in pre-condition at 85±2°C, allow parts to stabilize for 24±2 hours, at room temperature before measurement.</p> <p>Charge and discharge current of the capacitor must not exceed 50mA for IR measurement.</p> <p>Substrate for test is referred to Fig.3.</p>	Appearance	No problem observed
			Capacitance Change	Within ±12.5%of the initial capacitance.
			Dissipation Factor(tanδ)	Within 25.0%
			IR	50MQ·μF or over

## 6. Soldering Heat Resistance

No	Item	Test Conditions	Specifications										
1	Soldering Heat Resistance	Keep the sample at 150+0/- 10 °C for 1 hour, leave the sample at room ambient for 24±2 hours. Measure the initial capacitance and dissipation factor.  <Pre-heating conditions> <table border="1"> <thead> <tr> <th>Order</th> <th>Temperature</th> <th>Time</th> </tr> </thead> <tbody> <tr> <td>1</td> <td>80~100°C</td> <td>2min</td> </tr> <tr> <td>2</td> <td>150~200°C</td> <td>2min</td> </tr> </tbody> </table> Soak the sample in 260±5 °C solder for 10±0.5 seconds and leave the sample at room ambient, and measure the electrical properties after 24 ±2 hours.  IR and the charge-and-discharge current of electric strength measurement are 50mA or less.  Substrate for test is referred to Fig.3.	Order	Temperature	Time	1	80~100°C	2min	2	150~200°C	2min	Appearance	No problem observed
			Order	Temperature	Time								
			1	80~100°C	2min								
			2	150~200°C	2min								
			Capacitance Change	Within ±7.5% of the initial capacitance									
Dissipation Factor(tanδ)	Within 12.5%												
IR	500MΩ·μF or over												
Dielectric Resistance	Dielectric breakdown should not occur.												

## 7.Solderability

No	Item	Test Conditions	Specifications	
1	Solderability	Lead-free soldering (Sn-3.0Ag-0.5Cu) Soak the sample in 245±5 °C lead-free solder for 3±0.5 seconds.  Eutectic solder Soak the sample in 235±5 °C eutectic solder for 2±0.5 seconds.	Appearance	Solder coverage: 90% min.

■For lead-free soldering Recommended temperature profile

•Reflow profile

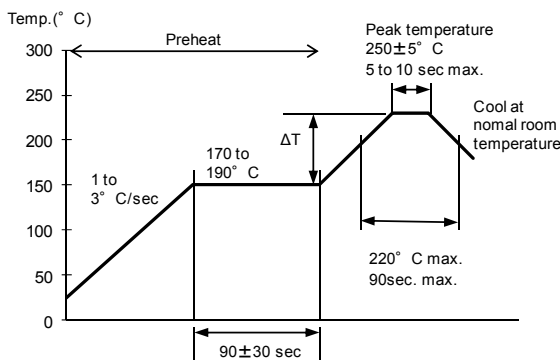

- (1) Minimize soldering time
- (2) Ensure that the temperature difference does not exceed 150 °C.
- (3) MLCC can withstand the above reflow conditions up to 3 times.
- (4) Cool naturally after soldering.

•Flow profile

Flow is not applicable for chips with size CM02.

•Soldering iron profile

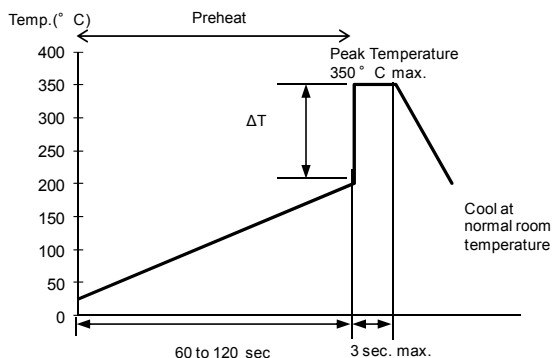

- (1) Ensure that the chip capacitor is preheated adequately.
- (2) Ensure that the temperature difference between a capacitor and the soldering iron shall not exceed 150 °C.
- (3) Cool naturally after soldering.
- (4) Avoid direct touching to capacitors.
- (5) Tip shape of soldering iron is dia.3.0mm max.
- (6) Wattage 80W max.

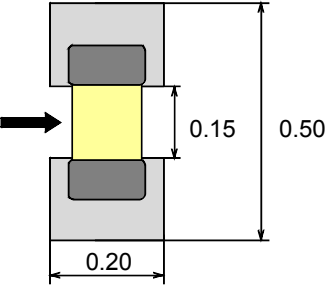

## 8.Mechanical Strength

No	Item	Test Conditions	Specifications	
1	Termination Strength	<p>Apply a sideward force of 1N to a PCB-mounted sample. Substrate material: Glass epoxy.</p>  <p>Fig. 4. Substrate for adhesion strength test</p>	Appearance	No problem observed
2	Vibration Test	<p>Keep the sample at 150+0/- 10 °C for 1 hour, leave the sample at room ambient for 24±2 hours. Measure the initial capacitance and dissipation factor.</p> <p>Vibration frequency :10 to 55 (Hz) Amplitude : 1.5mm Sweeping condition : 10 -&gt;55-&gt;10Hz/1 minute In X, Y and Z direction : 2 hours each Total 6 hours</p> <p>Substrate for test is referred to Figure 3.</p>	Appearance	No problem observed.
			Capacitance Change	Within ±10% of the initial capacitance
			Dissipation Factor(tanδ)	Within 12.5%

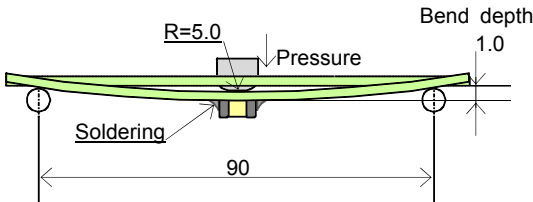
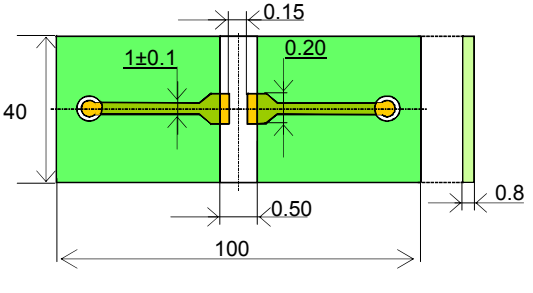
No	Item	Test Conditions	Specifications	
3	Bending Strength	<p>Keep the sample at 150+0/- 10 °C for 1 hour, leave the sample at room ambient for 24±2 hours. Measure the initial capacitance.</p> <p>Substrate material: Glass epoxy Test time : 10 seconds</p>  <p>(Unit:mm)</p> <p>Fig. 5 Testing status</p>	Appearance	No problem observed.
		 <p>(Unit:mm)</p> <p>Fig. 6 Substrate for bending test</p>	Capacitance Change	Within ±10% of the initial capacitance.

9.Packaging material

(1) Plastic reel dimensions

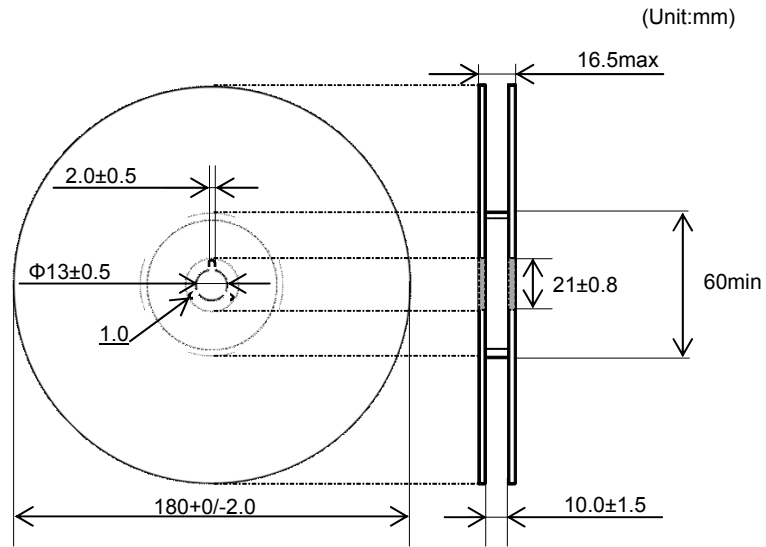

Fig.7 Reel dimensions

(2) Carrier tape dimensions

Pitch= $2.0 \pm 0.05$ mm (Packaging code:H) Paper carrier tape

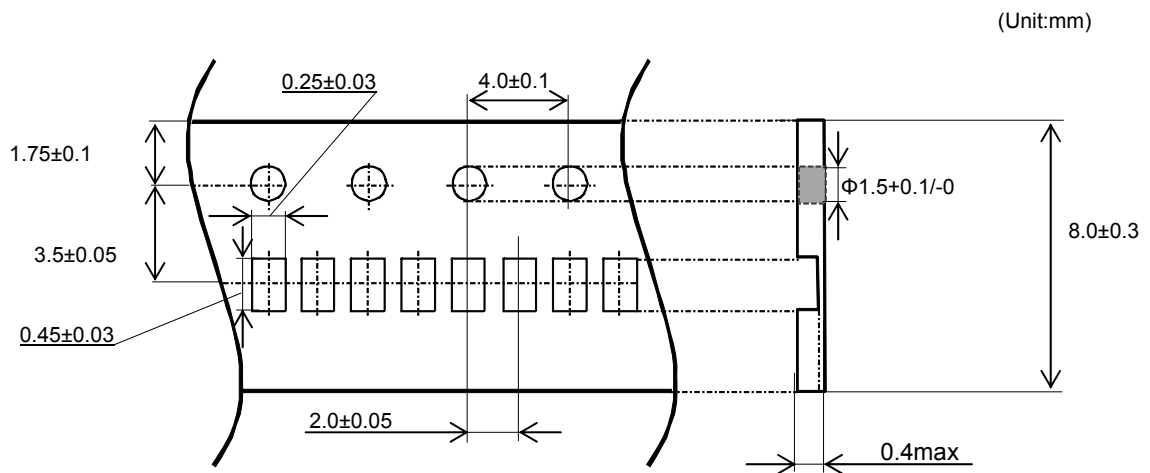

Fig 8.Carrier tape dimensions

(3) Maximum packaging quantity

Maximum packaging quantity : 20000 pieces /  $\Phi$  180mm reel



10.Packaging style

1. Taping

(1) Taping packaging

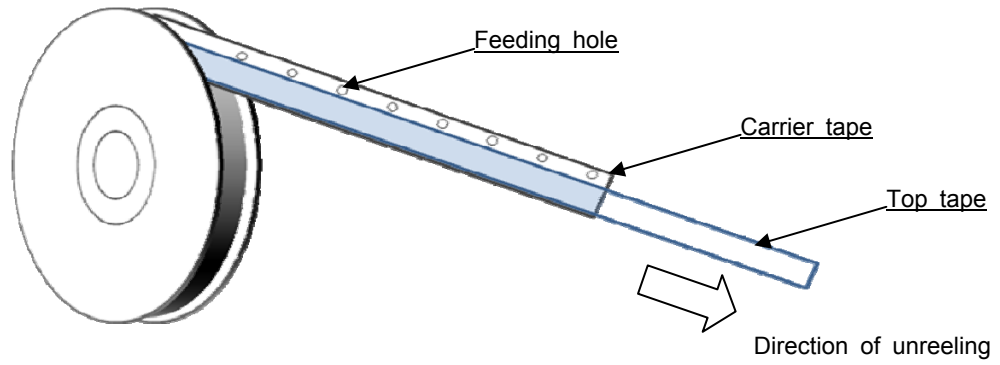

Fig. 9 Taping packaging schema

There are no capacitors in the leader and the trailer portion in taping packaging (refer to Fig. 10).  
End of the tape is not fixed to the reel to be released from the hub.

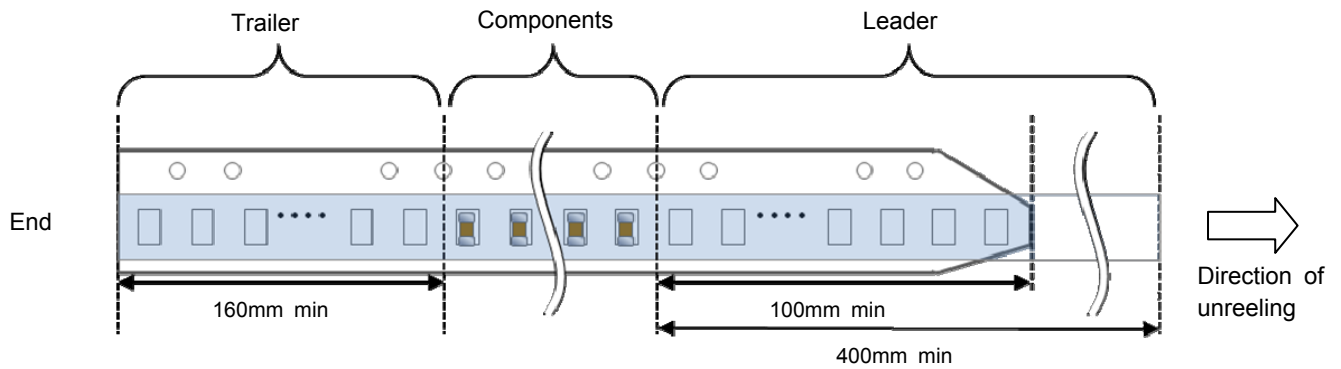

Fig.10 Detail of leader and trailer

(2) Peeling strength of the top tape

The peeling strength when peeling off the top tape from the carrier tape by the method of the following figure shall be 0.1 to 0.5 N. (Refer to Fig 11)

Peeling angle: 165 to 180 degrees to the carrier tape.

Peeling speed: 300mm/min

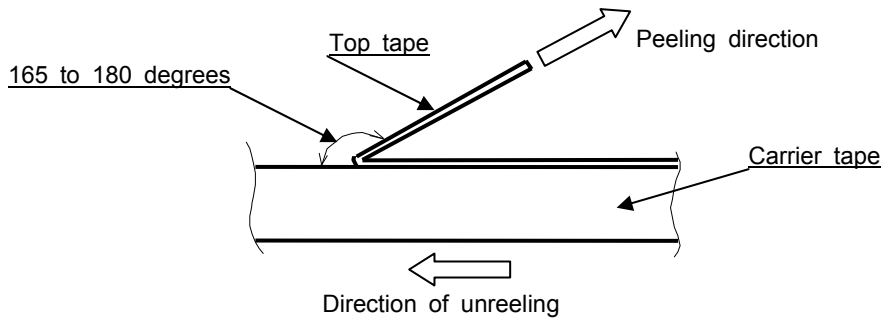

Fig.11 Peeling of the top tape (cross sectional view)

(3) Others

When bent a carrier tape at 25mm in radius, there is neither lack of a capacitor nor breakage of a tape (refer to Fig. 12).

When a top tape is peeled off, glue of the top tape adheres to the top tape side. Capacitors should not be adhered to the top tape.

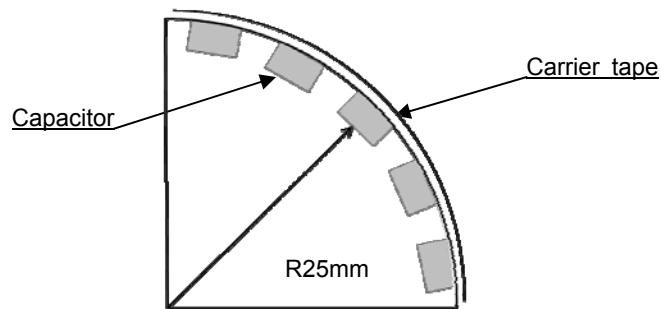

Fig.12 Carrier tape bending (cross sectional view)

11.Label and location

(1) Label location for reels

The label shall be placed on one side of a reel (refer to Fig. 13).

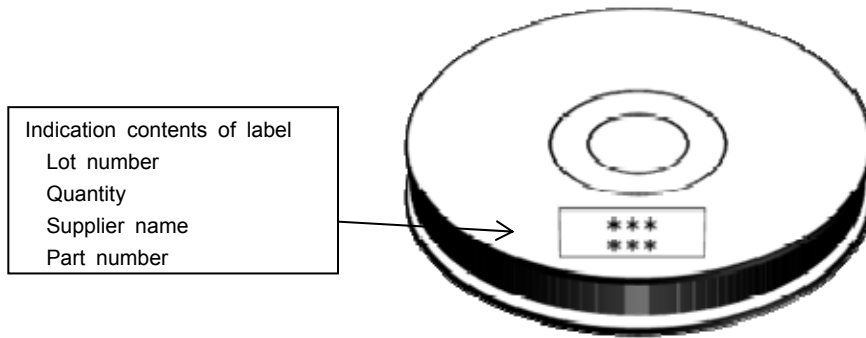

Fig. 13 Label location for reels

(2) Label location for packaging boxes

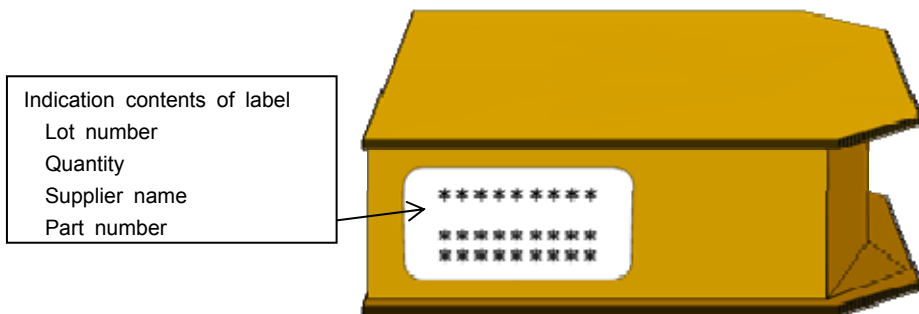

Fig. 14 Label location for packaging boxes

12.Production Site

Kagoshima Kokubu plant

(1-1, Kokubu-yamashita-cho, Kirishima-shi, Kagoshima)



## 13. Precautions

## ■ Handling

- 1) Cracks may occur unless otherwise avoiding excessive stress to the capacitors by the load of an adsorption nozzle, and bending of a substrate at the time of mounting.
- 2) Please arrange the capacitor position where they don't have too much stress of board bending after mounting.
- 3) Please design that the form and size of the land pattern has suitable solder amount.  
Otherwise cracks may occur. The recommended fillet height shall be 1/2 to 1/3 of the thickness of capacitors.

## ■ Circuit Design

- 1) When AC voltage is superimposed on DC voltage, the zero-to-peak voltage shall not exceed the rated voltage. When the capacitor is to be employed in a circuit in which there is continuous application of a high frequency Voltage or a steep pulse voltage, even though it is within the rated voltage, please inquire to the manufacturer.
- 2) Please use the capacitor below the maximum temperature.  
When using the capacitor in a self-heating AC circuit, please make sure the surface of the capacitor remains under the maximum temperature for usage. Also, please make certain temperature rises remain below 20 °C.

## ■ Resin coating

Please use the resin of low curing shrinkage type. (Otherwise cracks may occur).

## ■ Storage

- 1) When the components is stored in minimal packaging (a heat-sealed or chuck-type plastic bag), the bag should be kept closed. Once the bag has been opened, reseal it or store it in a desiccator.
- 2) Keep storage place temperature +5 to +40 °C, humidity 20 to 70% RH.
- 3) The storage atmosphere must be free of gas containing sulfur and chlorine. Also, avoid exposing the product to saline moisture. If the product is exposed to such atmospheres, the terminals will oxidize and solderability will be effected.
- 4) Precautions 1) to 3) apply to chip capacitors packaged in carrier tapes and bulk cases.
- 5) The solderability is assured for 6 months from our shipping date if the above storage precautions are followed.

## ■ Application Restriction

Please consult with us before using a capacitor in the equipment which requires a high degree reliability (medical equipment, aerospace applications, nuclear equipment.) Malfunctions in medical, space, nuclear power or other vital equipment may result in death or great social losses. Capacitors designed specially with high reliability are used for the equipment above.

## ■ Export regulation

When the applying products relate the strategic materials which are provided in Foreign Exchange and Foreign Trade Act and Foreign Trade Management Law, the export license based on these laws are required.

## ■ Disposal

Please dispose the capacitors according to the relating laws about the waste treatment and cleaning. Safety application guideline and detailed information of electrical properties are also provided in Kyocera home page:

URL: <http://www.kyocera.co.jp/electronic>

## Notice:

This specification shall guarantee only monolithic capacitors. Please make sure the performance of capacitors after mounted on the assembled product.

Any failures occurred being used out of this specification shall not be guaranteed.

This specification shall be applied to the products purchased through the regular sales routes, such as the sale offices, the subsidiaries and the distributors, etc.).



14.Revision History

No.	Date	Contents	APPD	CHKD	CHKD	PREPD
1	2016/07/04	New issue				





单击下面可查看定价，库存，交付和生命周期等信息

[>>Kyocera\(京瓷\)](#)