

# BFP840ESD

Robust Low Noise Silicon Germanium Bipolar RF Transistor

## Data Sheet

Revision 1.2, 2013-03-28

RF & Protection Devices

**Edition 2013-03-28**

**Published by  
Infineon Technologies AG  
81726 Munich, Germany**

**© 2013 Infineon Technologies AG  
All Rights Reserved.**

### **Legal Disclaimer**

The information given in this document shall in no event be regarded as a guarantee of conditions or characteristics. With respect to any examples or hints given herein, any typical values stated herein and/or any information regarding the application of the device, Infineon Technologies hereby disclaims any and all warranties and liabilities of any kind, including without limitation, warranties of non-infringement of intellectual property rights of any third party.

### **Information**

For further information on technology, delivery terms and conditions and prices, please contact the nearest Infineon Technologies Office ([www.infineon.com](http://www.infineon.com)).

### **Warnings**

Due to technical requirements, components may contain dangerous substances. For information on the types in question, please contact the nearest Infineon Technologies Office.

Infineon Technologies components may be used in life-support devices or systems only with the express written approval of Infineon Technologies, if a failure of such components can reasonably be expected to cause the failure of that life-support device or system or to affect the safety or effectiveness of that device or system. Life support devices or systems are intended to be implanted in the human body or to support and/or maintain and sustain and/or protect human life. If they fail, it is reasonable to assume that the health of the user or other persons may be endangered.

**BFP840ESD, Robust Low Noise Silicon Germanium Bipolar RF Transistor**

**Revision History: 2013-03-28, Revision 1.2**

Page	Subjects (major changes since last revision)
	This data sheet replaces the revision from 2012-07-11.
P. 8	Item about AEC-Q101 added to feature list, minor changes.
P. 27	Picture for marking description updated.

**Trademarks of Infineon Technologies AG**

AURIX™, C166™, CanPAK™, CIPOS™, CIPURSE™, EconoPACK™, CoolMOS™, CoolSET™, CORECONTROL™, CROSSAVE™, DAVE™, DI-POL™, EasyPIM™, EconoBRIDGE™, EconoDUAL™, EconoPIM™, EconoPACK™, EiceDRIVER™, eupec™, FCOS™, HITFET™, HybridPACK™, I<sup>2</sup>RF™, ISOFACE™, IsoPACK™, MIPAQ™, ModSTACK™, my-d™, NovalithIC™, OptiMOS™, ORIGA™, POWERCODE™, PRIMARION™, PrimePACK™, PrimeSTACK™, PRO-SIL™, PROFET™, RASIC™, ReverSave™, SatRIC™, SIEGET™, SINDRION™, SIPMOS™, SmartLEWIS™, SOLID FLASH™, TEMPFET™, thinQ!™, TRENCHSTOP™, TriCore™.

**Other Trademarks**

Advance Design System™ (ADS) of Agilent Technologies, AMBA™, ARM™, MULTI-ICE™, KEIL™, PRIMECELL™, REALVIEW™, THUMB™, µVision™ of ARM Limited, UK. AUTOSAR™ is licensed by AUTOSAR development partnership. Bluetooth™ of Bluetooth SIG Inc. CAT-ig™ of DECT Forum. COLOSSUS™, FirstGPS™ of Trimble Navigation Ltd. EMV™ of EMVCo, LLC (Visa Holdings Inc.). EPCOS™ of Epcos AG. FLEXGO™ of Microsoft Corporation. FlexRay™ is licensed by FlexRay Consortium. HYPERTERMINAL™ of Hilgraeve Incorporated. IEC™ of Commission Electrotechnique Internationale. IrDA™ of Infrared Data Association Corporation. ISO™ of INTERNATIONAL ORGANIZATION FOR STANDARDIZATION. MATLAB™ of MathWorks, Inc. MAXIM™ of Maxim Integrated Products, Inc. MICROTEC™, NUCLEUS™ of Mentor Graphics Corporation. MIPI™ of MIPI Alliance, Inc. MIPS™ of MIPS Technologies, Inc., USA. muRata™ of MURATA MANUFACTURING CO., MICROWAVE OFFICE™ (MWO) of Applied Wave Research Inc., OmniVision™ of OmniVision Technologies, Inc. Openwave™ Openwave Systems Inc. RED HAT™ Red Hat, Inc. RFMD™ RF Micro Devices, Inc. SIRIUS™ of Sirius Satellite Radio Inc. SOLARIS™ of Sun Microsystems, Inc. SPANSION™ of Spansion LLC Ltd. Symbian™ of Symbian Software Limited. TAIYO YUDEN™ of Taiyo Yuden Co. TEAKLITE™ of CEVA, Inc. TEKTRONIX™ of Tektronix Inc. TOKO™ of TOKO KABUSHIKI KAISHA TA. UNIX™ of X/Open Company Limited. VERILOG™, PALLADIUM™ of Cadence Design Systems, Inc. VLYNQ™ of Texas Instruments Incorporated. VXWORKS™, WIND RIVER™ of WIND RIVER SYSTEMS, INC. ZETEX™ of Diodes Zetex Limited.

Last Trademarks Update 2011-11-11

## Table of Contents

	<b>Table of Contents</b> .....	4
	<b>List of Figures</b> .....	5
	<b>List of Tables</b> .....	6
<b>1</b>	<b>Product Brief</b> .....	7
<b>2</b>	<b>Features</b> .....	8
<b>3</b>	<b>Maximum Ratings</b> .....	9
<b>4</b>	<b>Thermal Characteristics</b> .....	10
<b>5</b>	<b>Electrical Characteristics</b> .....	11
5.1	DC Characteristics .....	11
5.2	General AC Characteristics .....	11
5.3	Frequency Dependent AC Characteristics .....	12
5.4	Characteristic DC Diagrams .....	16
5.5	Characteristic AC Diagrams .....	19
<b>6</b>	<b>Simulation Data</b> .....	26
<b>7</b>	<b>Package Information SOT343</b> .....	27

**List of Figures**

Figure 4-1	Total Power Dissipation $P_{tot} = f(T_s)$ .....	10
Figure 5-1	BFP840ESD Testing Circuit .....	12
Figure 5-2	Collector Current vs. Collector Emitter Voltage $I_C = f(V_{CE}), I_B = \text{Parameter}$ .....	16
Figure 5-3	DC Current Gain $h_{FE} = f(I_C), V_{CE} = 1.8 \text{ V}$ .....	16
Figure 5-4	Collector Current vs. Base Emitter Forward Voltage $I_C = f(V_{BE}), V_{CE} = 1.8 \text{ V}$ .....	17
Figure 5-5	Base Current vs. Base Emitter Forward Voltage $I_B = f(V_{BE}), V_{CE} = 1.8 \text{ V}$ .....	17
Figure 5-6	Base Current vs. Base Emitter Reverse Voltage $I_B = f(V_{EB}), V_{CE} = 1.8 \text{ V}$ .....	18
Figure 5-7	Transition Frequency $f_T = f(I_C), f = 2 \text{ GHz}, V_{CE} = \text{Parameter}$ .....	19
Figure 5-8	3rd Order Intercept Point at output $OIP3 = f(I_C), Z_S = Z_L = 50 \Omega, V_{CE}, f = \text{Parameters}$ .....	19
Figure 5-9	3rd Order Intercept Point at output $OIP3 \text{ [dBm]} = f(I_C, V_{CE}), Z_S = Z_L = 50 \Omega, f = 5.5 \text{ GHz}$ .....	20
Figure 5-10	Compression Point at output $OP_{1dB} \text{ [dBm]} = f(I_C, V_{CE}), Z_S = Z_L = 50 \Omega, f = 5.5 \text{ GHz}$ .....	20
Figure 5-11	Collector Base Capacitance $C_{CB} = f(V_{CB}), f = 1 \text{ MHz}$ .....	21
Figure 5-12	Gain $G_{ma}, G_{ms},  S_{21} ^2 = f(f), V_{CE} = 1.8 \text{ V}, I_C = 10 \text{ mA}$ .....	21
Figure 5-13	Maximum Power Gain $G_{max} = f(I_C), V_{CE} = 1.8 \text{ V}, f = \text{Parameter in GHz}$ .....	22
Figure 5-14	Maximum Power Gain $G_{max} = f(V_{CE}), I_C = 10 \text{ mA}, f = \text{Parameter in GHz}$ .....	22
Figure 5-15	Input Reflection Coefficient $S_{11} = f(f), V_{CE} = 1.8 \text{ V}, I_C = 5 / 10 / 15 \text{ mA}$ .....	23
Figure 5-16	Source Impedance for Minimum Noise Figure $Z_{opt} = f(f), V_{CE} = 1.8 \text{ V}, I_C = 5 / 10 / 15 \text{ mA}$ .....	23
Figure 5-17	Output Reflection Coefficient $S_{22} = f(f), V_{CE} = 1.8 \text{ V}, I_C = 5 / 10 / 15 \text{ mA}$ .....	24
Figure 5-18	Noise Figure $NF_{min} = f(f), V_{CE} = 1.8 \text{ V}, I_C = 5 / 10 / 15 \text{ mA}, Z_S = Z_{opt}$ .....	24
Figure 5-19	Noise Figure $NF_{min} = f(I_C), V_{CE} = 1.8 \text{ V}, Z_S = Z_{opt}, f = \text{Parameter in GHz}$ .....	25
Figure 5-20	Noise Figure $NF_{50} = f(I_C), V_{CE} = 1.8 \text{ V}, Z_S = 50 \Omega, f = \text{Parameter in GHz}$ .....	25
Figure 7-1	Package Outline .....	27
Figure 7-2	Package Footprint .....	27
Figure 7-3	Marking Description (Marking BFP840ESD: T8s) .....	27
Figure 7-4	Tape Dimensions .....	27

## List of Tables

Table 3-1	Maximum Ratings at $T_A = 25\text{ °C}$ (unless otherwise specified) . . . . .	9
Table 4-1	Thermal Resistance . . . . .	10
Table 5-1	DC Characteristics at $T_A = 25\text{ °C}$ . . . . .	11
Table 5-2	General AC Characteristics at $T_A = 25\text{ °C}$ . . . . .	11
Table 5-3	AC Characteristics, $V_{CE} = 1.8\text{ V}, f = 0.45\text{ GHz}$ . . . . .	12
Table 5-4	AC Characteristics, $V_{CE} = 1.8\text{ V}, f = 0.9\text{ GHz}$ . . . . .	13
Table 5-5	AC Characteristics, $V_{CE} = 1.8\text{ V}, f = 1.5\text{ GHz}$ . . . . .	13
Table 5-6	AC Characteristics, $V_{CE} = 1.8\text{ V}, f = 1.9\text{ GHz}$ . . . . .	13
Table 5-7	AC Characteristics, $V_{CE} = 1.8\text{ V}, f = 2.4\text{ GHz}$ . . . . .	14
Table 5-8	AC Characteristics, $V_{CE} = 1.8\text{ V}, f = 3.5\text{ GHz}$ . . . . .	14
Table 5-9	AC Characteristics, $V_{CE} = 1.8\text{ V}, f = 5.5\text{ GHz}$ . . . . .	14
Table 5-10	AC Characteristics, $V_{CE} = 1.8\text{ V}, f = 10\text{ GHz}$ . . . . .	15
Table 5-11	AC Characteristics, $V_{CE} = 1.8\text{ V}, f = 12\text{ GHz}$ . . . . .	15

## 1 Product Brief

The BFP840ESD is a high performance HBT (Heterojunction Bipolar Transistor) specifically designed for 5-6 GHz Wi-Fi applications. The device is based on Infineon's reliable high volume SiGe:C technology.

The BFP840ESD provides inherently good input and output power match as well as inherently good noise match at 5-6 GHz. The simultaneous noise and power match without lossy external matching components at the input leads to a low external parts count, to a very good noise figure and to a very high transducer gain in the Wi-Fi application. Integrated protection elements at in- and output make the device robust against ESD and excessive RF input power.

The device offers its high performance at low current and voltage and is especially well-suited for portable battery-powered applications in which energy efficiency is a key requirement. The device comes in an easy to use industry standard package with visible leads.

## 2 Features

- Robust very low noise amplifier based on Infineon’s reliable high volume SiGe:C technology
- Unique combination of high end RF performance and robustness: 20 dBm maximum RF input power, 1.5 kV HBM ESD hardness
- Very high transition frequency  $f_T = 80$  GHz enables very low noise figure at high frequencies:  
 $NF_{min} = 0.85$  dB at 5.5 GHz, 1.8 V, 6 mA
- High gain  $|S_{21}|^2 = 18.5$  dB at 5.5 GHz, 1.8 V, 10 mA
- $OIP3 = 23$  dBm at 5.5 GHz, 1.5 V, 6 mA
- Ideal for low voltage applications e.g.  $V_{CC} = 1.2$  V and 1.8 V (2.85 V, 3.3 V, 3.6 V requires corresponding collector resistor)
- Low power consumption, ideal for mobile applications
- Easy to use Pb free (RoHS compliant) and halogen free industry standard package with visible leads
- Qualification report according to AEC-Q101 available

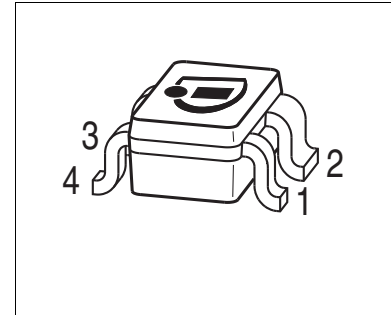

SOT343



### Applications

As Low Noise Amplifier (LNA) in

- Mobile and fixed connectivity applications: WLAN 802.11, WiMAX and UWB
- Satellite communication systems: satellite radio (SDARs, DAB), navigation systems (e.g. GPS, Glonass) and C-band LNB (1st and 2nd stage LNA)
- Ku-band LNB front-end (2nd stage or 3rd stage LNA and active mixer)
- Ka-band oscillators (DROs)

**Attention: ESD (Electrostatic discharge) sensitive device, observe handling precautions**

Product Name	Package	Pin Configuration				Marking
BFP840ESD	SOT343	1 = B	2 = E	3 = C	4 = E	T8s



### 3 Maximum Ratings

**Table 3-1 Maximum Ratings at  $T_A = 25\text{ °C}$  (unless otherwise specified)**

Parameter	Symbol	Values		Unit	Note / Test Condition
		Min.	Max.		
Collector emitter voltage	$V_{CEO}$	–	2.25 2.0	V	$T_A = 25\text{ °C}$ $T_A = -55\text{ °C}$ Open base
Collector emitter voltage <sup>1)</sup>	$V_{CES}$	–	2.25 2.0	V	$T_A = 25\text{ °C}$ $T_A = -55\text{ °C}$ E-B short circuited
Collector base voltage <sup>2)</sup>	$V_{CBO}$	–	2.9 2.6	V	$T_A = 25\text{ °C}$ $T_A = -55\text{ °C}$ Open emitter
Base current	$I_B$	-5	3	mA	–
Collector current	$I_C$	–	35	mA	–
RF input power	$P_{RFIn}$	–	20	dBm	–
ESD stress pulse	$V_{ESD}$	-1.5	1.5	kV	HBM, all pins, acc. to JESD22-A114
Total power dissipation <sup>3)</sup>	$P_{tot}$	–	75	mW	$T_S \leq 108\text{ °C}$
Junction temperature	$T_J$	–	150	°C	–
Storage temperature	$T_{Stg}$	-55	150	°C	–

1)  $V_{CES}$  is identical to  $V_{CEO}$  due to design.

2)  $V_{CBO}$  is similar to  $V_{CEO}$  due to design.

3)  $T_S$  is the soldering point temperature.  $T_S$  is measured on the emitter lead at the soldering point of the pcb.

**Attention: Stresses above the max. values listed here may cause permanent damage to the device. Exposure to absolute maximum rating conditions for extended periods may affect device reliability. Maximum ratings are absolute ratings; exceeding only one of these values may cause irreversible damage to the integrated circuit.**

## 4 Thermal Characteristics

Table 4-1 Thermal Resistance

Parameter	Symbol	Values			Unit	Note / Test Condition
		Min.	Typ.	Max.		
Junction - soldering point <sup>1)</sup>	$R_{thJS}$	–	551	–	K/W	–

1) For the definition of  $R_{thJS}$  please refer to Application Note AN077 (Thermal Resistance Calculation).

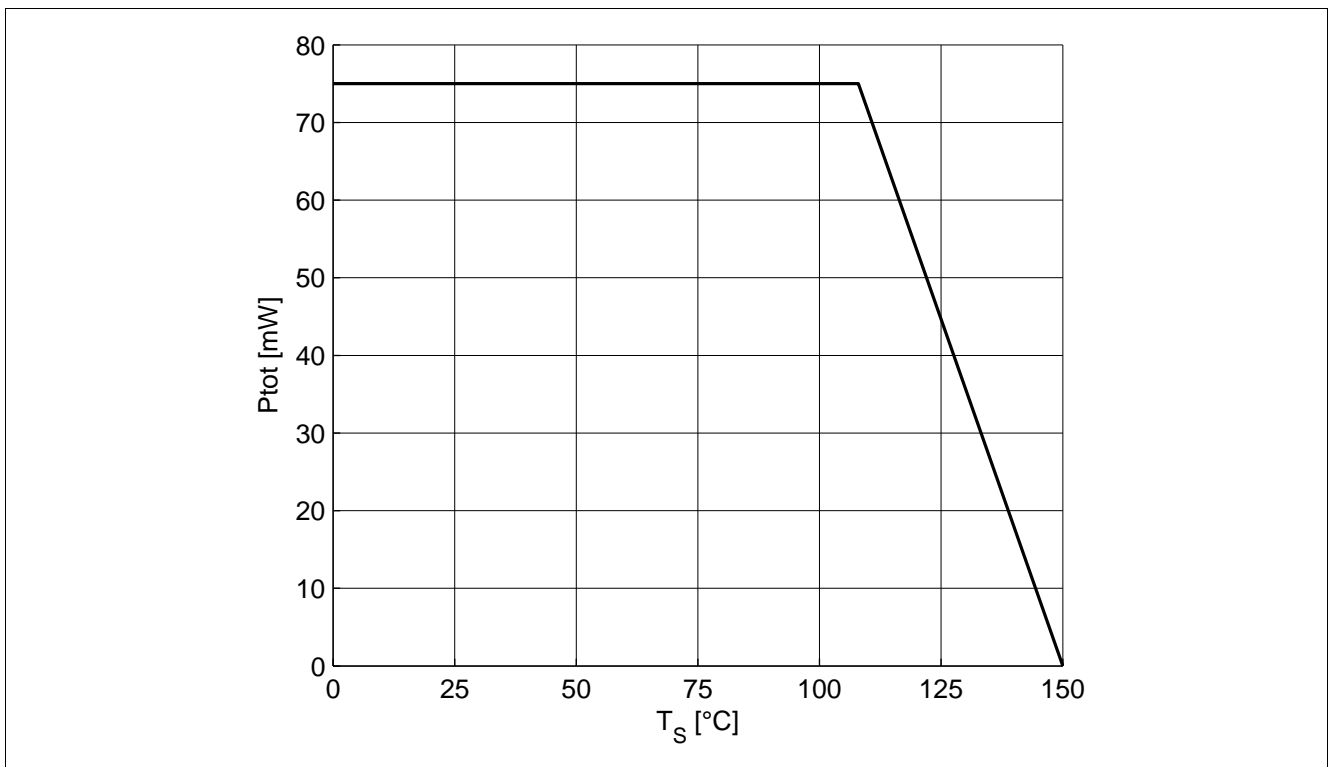

Figure 4-1 Total Power Dissipation  $P_{tot} = f(T_s)$

## 5 Electrical Characteristics

### 5.1 DC Characteristics

**Table 5-1 DC Characteristics at  $T_A = 25\text{ }^\circ\text{C}$** 

Parameter	Symbol	Values			Unit	Note / Test Condition
		Min.	Typ.	Max.		
Collector emitter breakdown voltage	$V_{(BR)CEO}$	2.25	2.6		V	$I_C = 1\text{ mA}$ , $I_B = 0$ Open base
Collector emitter leakage current	$I_{CES}$	–	–	400	nA	$V_{CE} = 1.5\text{ V}$ , $V_{BE} = 0$ E-B short circuited
Collector base leakage current	$I_{CBO}$	–	–	400	nA	$V_{CB} = 1.5\text{ V}$ , $I_E = 0$ Open emitter
Emitter base leakage current	$I_{EBO}$	–	–	10	$\mu\text{A}$	$V_{EB} = 0.5\text{ V}$ , $I_C = 0$ Open collector
DC current gain	$h_{FE}$	150	260	450		$V_{CE} = 1.8\text{ V}$ , $I_C = 10\text{ mA}$ Pulse measured

### 5.2 General AC Characteristics

**Table 5-2 General AC Characteristics at  $T_A = 25\text{ }^\circ\text{C}$** 

Parameter	Symbol	Values			Unit	Note / Test Condition
		Min.	Typ.	Max.		
Transition frequency	$f_T$	–	80	–	GHz	$V_{CE} = 1.8\text{ V}$ , $I_C = 25\text{ mA}$ $f = 2\text{ GHz}$
Collector base capacitance	$C_{CB}$	–	37	–	fF	$V_{CB} = 1.8\text{ V}$ , $V_{BE} = 0$ $f = 1\text{ MHz}$ Emitter grounded
Collector emitter capacitance	$C_{CE}$	–	0.40	–	pF	$V_{CE} = 1.8\text{ V}$ , $V_{BE} = 0$ $f = 1\text{ MHz}$ Base grounded
Emitter base capacitance	$C_{EB}$	–	0.41	–	pF	$V_{EB} = 0.4\text{ V}$ , $V_{CB} = 0$ $f = 1\text{ MHz}$ Collector grounded

### 5.3 Frequency Dependent AC Characteristics

Measurement setup is a test fixture with Bias T's in a 50  $\Omega$  system,  $T_A = 25\text{ }^\circ\text{C}$

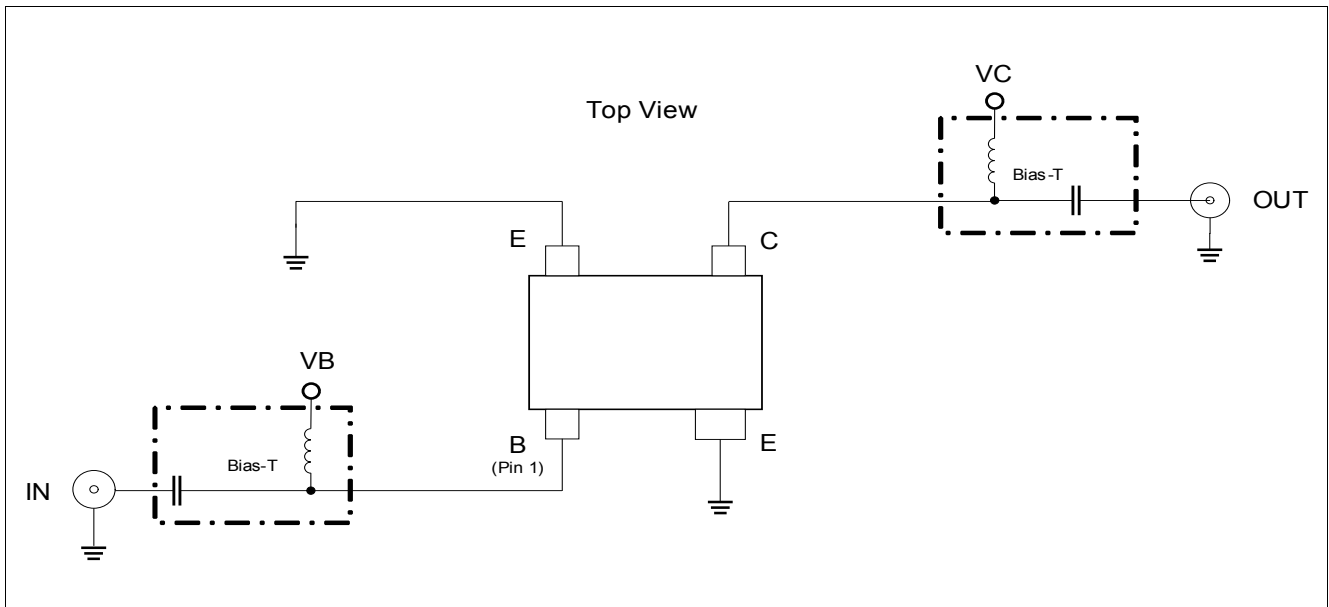

**Figure 5-1 BFP840ESD Testing Circuit**

**Table 5-3 AC Characteristics,  $V_{CE} = 1.8\text{ V}$ ,  $f = 0.45\text{ GHz}$**

Parameter	Symbol	Values			Unit	Note / Test Condition
		Min.	Typ.	Max.		
<b>Power Gain</b>					dB	
Maximum power gain	$G_{rms}$	–	33.5	–		$I_C = 10\text{ mA}$
Transducer gain	$ S_{21} ^2$	–	27.5	–		$I_C = 10\text{ mA}$
<b>Minimum Noise Figure</b>					dB	
Minimum noise figure	$NF_{min}$	–	0.6	–		$I_C = 5\text{ mA}$
Associated gain	$G_{ass}$	–	26.5	–		$I_C = 5\text{ mA}$
<b>Linearity</b>					dBm	$Z_S = Z_L = 50\ \Omega$
1 dB compression point at output	$OP_{1dB}$	–	4	–		$I_C = 10\text{ mA}$
3rd order intercept point at output	$OIP3$	–	19.5	–		$I_C = 10\text{ mA}$

**Electrical Characteristics**
**Table 5-4 AC Characteristics,  $V_{CE} = 1.8\text{ V}$ ,  $f = 0.9\text{ GHz}$** 

Parameter	Symbol	Values			Unit	Note / Test Condition
		Min.	Typ.	Max.		
<b>Power Gain</b>						
Maximum power gain	$G_{ms}$	–	30	–	dB	$I_C = 10\text{ mA}$
Transducer gain	$ S_{21} ^2$	–	27	–		$I_C = 10\text{ mA}$
<b>Minimum Noise Figure</b>						
Minimum noise figure	$NF_{min}$	–	0.6	–	dB	$I_C = 5\text{ mA}$
Associated gain	$G_{ass}$	–	25.5	–		$I_C = 5\text{ mA}$
<b>Linearity</b>						
1 dB compression point at output	$OP_{1dB}$	–	4	–	dBm	$Z_S = Z_L = 50\ \Omega$
3rd order intercept point at output	$OIP3$	–	19.5	–		$I_C = 10\text{ mA}$

**Table 5-5 AC Characteristics,  $V_{CE} = 1.8\text{ V}$ ,  $f = 1.5\text{ GHz}$** 

Parameter	Symbol	Values			Unit	Note / Test Condition
		Min.	Typ.	Max.		
<b>Power Gain</b>						
Maximum power gain	$G_{ms}$	–	28	–	dB	$I_C = 10\text{ mA}$
Transducer gain	$ S_{21} ^2$	–	25.5	–		$I_C = 10\text{ mA}$
<b>Minimum Noise Figure</b>						
Minimum noise figure	$NF_{min}$	–	0.65	–	dB	$I_C = 5\text{ mA}$
Associated gain	$G_{ass}$	–	24	–		$I_C = 5\text{ mA}$
<b>Linearity</b>						
1 dB compression point at output	$OP_{1dB}$	–	4.0	–	dBm	$Z_S = Z_L = 50\ \Omega$
3rd order intercept point at output	$OIP3$	–	19.5	–		$I_C = 10\text{ mA}$

**Table 5-6 AC Characteristics,  $V_{CE} = 1.8\text{ V}$ ,  $f = 1.9\text{ GHz}$** 

Parameter	Symbol	Values			Unit	Note / Test Condition
		Min.	Typ.	Max.		
<b>Power Gain</b>						
Maximum power gain	$G_{ms}$	–	27	–	dB	$I_C = 10\text{ mA}$
Transducer gain	$ S_{21} ^2$	–	25	–		$I_C = 10\text{ mA}$
<b>Minimum Noise Figure</b>						
Minimum noise figure	$NF_{min}$	–	0.65	–	dB	$I_C = 5\text{ mA}$
Associated gain	$G_{ass}$	–	23	–		$I_C = 5\text{ mA}$
<b>Linearity</b>						
1 dB compression point at output	$OP_{1dB}$	–	4.5	–	dBm	$Z_S = Z_L = 50\ \Omega$
3rd order intercept point at output	$OIP3$	–	21	–		$I_C = 10\text{ mA}$

**Electrical Characteristics**
**Table 5-7 AC Characteristics,  $V_{CE} = 1.8\text{ V}$ ,  $f = 2.4\text{ GHz}$** 

Parameter	Symbol	Values			Unit	Note / Test Condition
		Min.	Typ.	Max.		
<b>Power Gain</b>						
Maximum power gain	$G_{ms}$	–	26	–	dB	$I_C = 10\text{ mA}$
Transducer gain	$ S_{21} ^2$	–	24	–		$I_C = 10\text{ mA}$
<b>Minimum Noise Figure</b>						
Minimum noise figure	$NF_{min}$	–	0.7	–	dB	$I_C = 5\text{ mA}$
Associated gain	$G_{ass}$	–	22	–		$I_C = 5\text{ mA}$
<b>Linearity</b>						
1 dB compression point at output	$OP_{1dB}$	–	4	–	dBm	$Z_S = Z_L = 50\ \Omega$
3rd order intercept point at output	$OIP3$	–	21	–		$I_C = 10\text{ mA}$

**Table 5-8 AC Characteristics,  $V_{CE} = 1.8\text{ V}$ ,  $f = 3.5\text{ GHz}$** 

Parameter	Symbol	Values			Unit	Note / Test Condition
		Min.	Typ.	Max.		
<b>Power Gain</b>						
Maximum power gain	$G_{ms}$	–	24.5	–	dB	$I_C = 10\text{ mA}$
Transducer gain	$ S_{21} ^2$	–	22	–		$I_C = 10\text{ mA}$
<b>Minimum Noise Figure</b>						
Minimum noise figure	$NF_{min}$	–	0.7	–	dB	$I_C = 5\text{ mA}$
Associated gain	$G_{ass}$	–	20	–		$I_C = 5\text{ mA}$
<b>Linearity</b>						
1 dB compression point at output	$OP_{1dB}$	–	5	–	dBm	$Z_S = Z_L = 50\ \Omega$
3rd order intercept point at output	$OIP3$	–	22.5	–		$I_C = 10\text{ mA}$

**Table 5-9 AC Characteristics,  $V_{CE} = 1.8\text{ V}$ ,  $f = 5.5\text{ GHz}$** 

Parameter	Symbol	Values			Unit	Note / Test Condition
		Min.	Typ.	Max.		
<b>Power Gain</b>						
Maximum power gain	$G_{ma}$	–	22.5	–	dB	$I_C = 10\text{ mA}$
Transducer gain	$ S_{21} ^2$	–	18.5	–		$I_C = 10\text{ mA}$
<b>Minimum Noise Figure</b>						
Minimum noise figure	$NF_{min}$	–	0.85	–	dB	$I_C = 5\text{ mA}$
Associated gain	$G_{ass}$	–	17	–		$I_C = 5\text{ mA}$
<b>Linearity</b>						
1 dB compression point at output	$OP_{1dB}$	–	5	–	dBm	$Z_S = Z_L = 50\ \Omega$
3rd order intercept point at output	$OIP3$	–	22	–		$I_C = 10\text{ mA}$

**Table 5-10 AC Characteristics,  $V_{CE} = 1.8\text{ V}$ ,  $f = 10\text{ GHz}$** 

Parameter	Symbol	Values			Unit	Note / Test Condition
		Min.	Typ.	Max.		
<b>Power Gain</b>						
Maximum power gain	$G_{ms}$	–	17	–	dB	$I_C = 10\text{ mA}$
Transducer gain	$ S_{21} ^2$	–	12	–		$I_C = 10\text{ mA}$
<b>Minimum Noise Figure</b>						
Minimum noise figure	$NF_{min}$	–	1.2	–	dB	$I_C = 5\text{ mA}$
Associated gain	$G_{ass}$	–	12.5	–		$I_C = 5\text{ mA}$
<b>Linearity</b>						
1 dB compression point at output	$OP_{1dB}$	–	2.5	–	dBm	$Z_S = Z_L = 50\ \Omega$
3rd order intercept point at output	$OIP3$	–	19.5	–		$I_C = 10\text{ mA}$

**Table 5-11 AC Characteristics,  $V_{CE} = 1.8\text{ V}$ ,  $f = 12\text{ GHz}$** 

Parameter	Symbol	Values			Unit	Note / Test Condition
		Min.	Typ.	Max.		
<b>Power gain</b>						
Maximum power gain	$G_{ms}$	–	15.5	–	dB	$I_C = 10\text{ mA}$
Transducer gain	$ S_{21} ^2$	–	9.5	–		$I_C = 10\text{ mA}$
<b>Minimum Noise Figure</b>						
Minimum noise figure	$NF_{min}$	–	1.45	–	dB	$I_C = 5\text{ mA}$
Associated gain	$G_{ass}$	–	11	–		$I_C = 5\text{ mA}$
<b>Linearity</b>						
1 dB compression point at output	$OP_{1dB}$	–	1.5	–	dBm	$Z_S = Z_L = 50\ \Omega$
3rd order intercept point at output	$OIP3$	–	18.5	–		$I_C = 10\text{ mA}$

Note:  $OIP3$  value depends on termination of all intermodulation frequency components. Termination used for this measurement is  $50\ \Omega$  from  $0.2\text{ MHz}$  to  $12\text{ GHz}$ .

5.4 Characteristic DC Diagrams

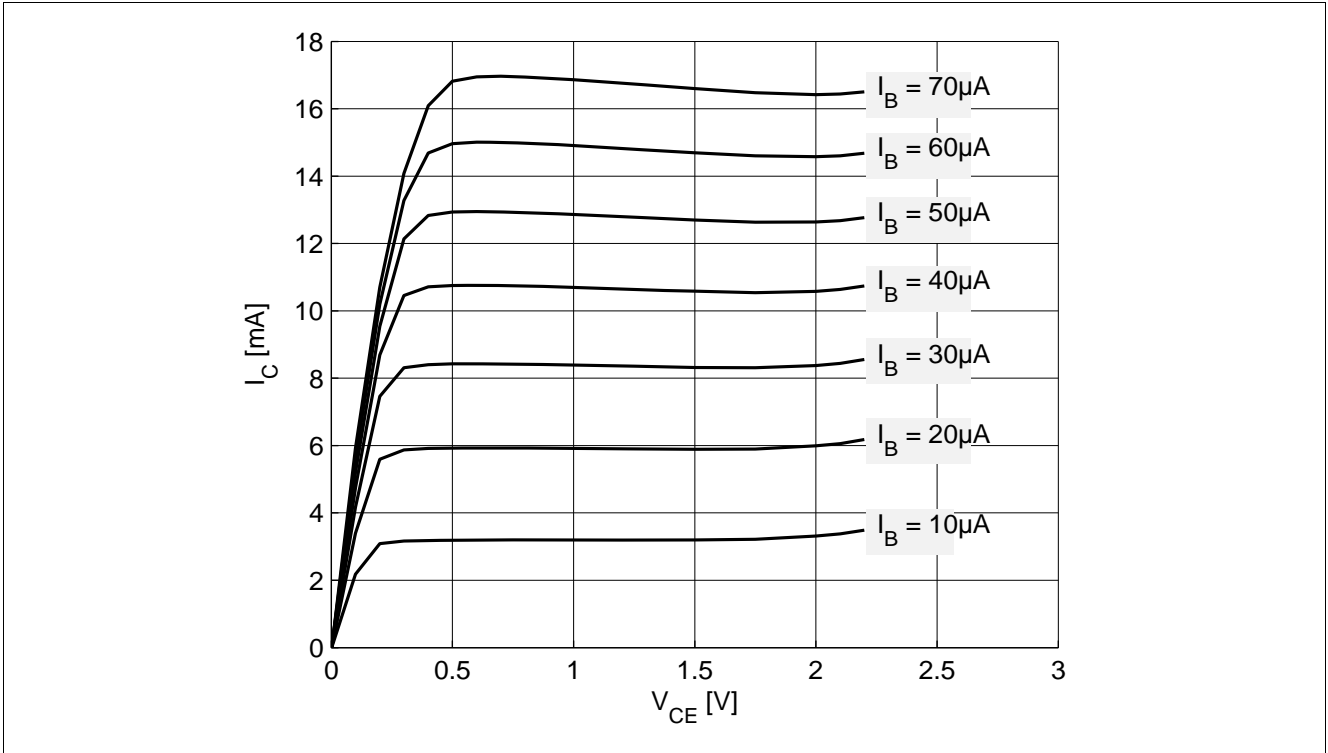

Figure 5-2 Collector Current vs. Collector Emitter Voltage  $I_C = f(V_{CE})$ ,  $I_B = \text{Parameter}$

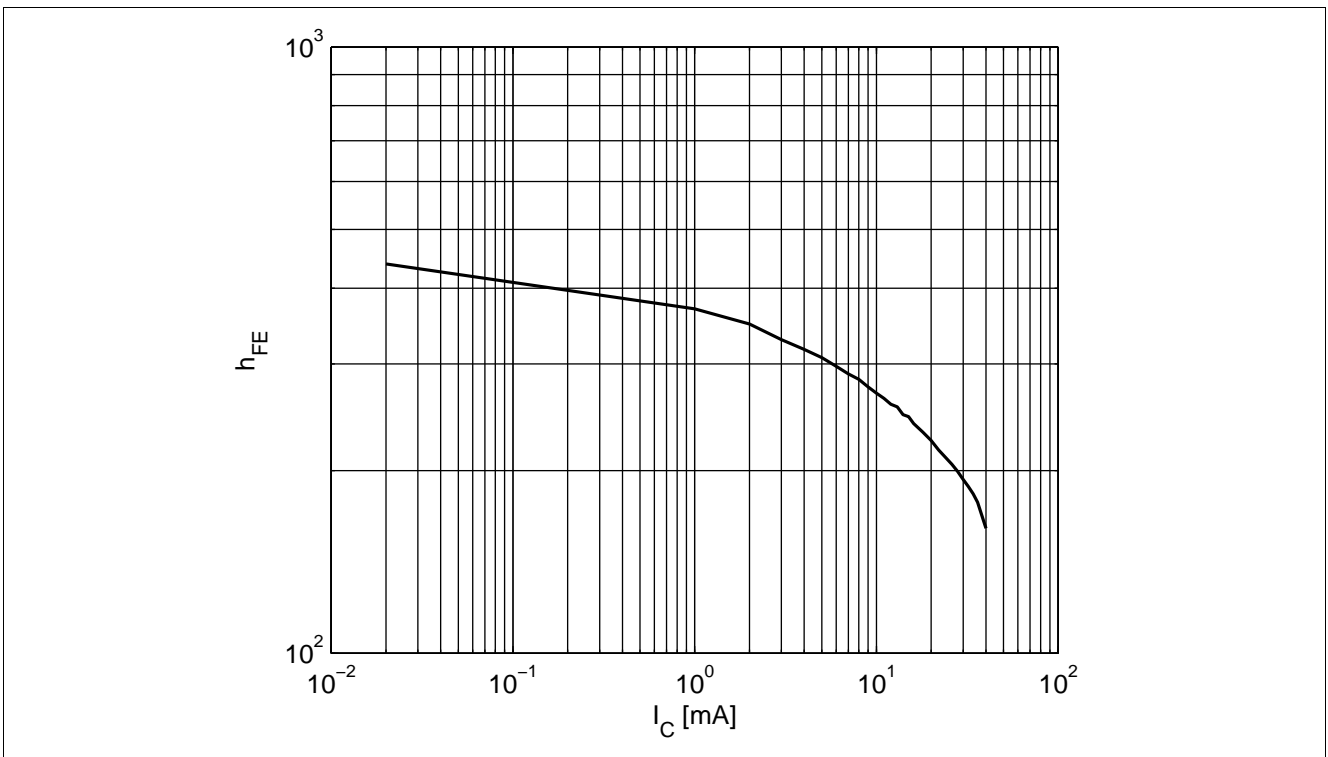

Figure 5-3 DC Current Gain  $h_{FE} = f(I_C)$ ,  $V_{CE} = 1.8 \text{ V}$



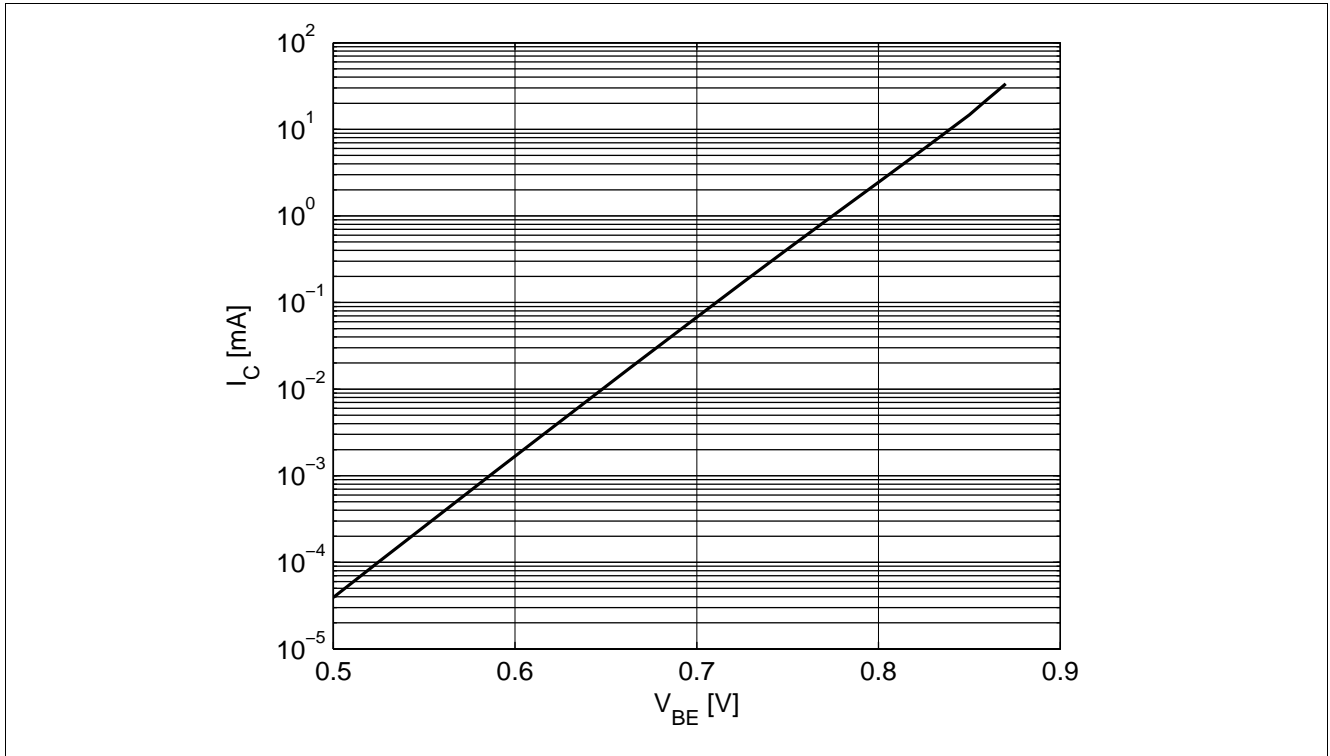

Figure 5-4 Collector Current vs. Base Emitter Forward Voltage  $I_C = f(V_{BE})$ ,  $V_{CE} = 1.8$  V

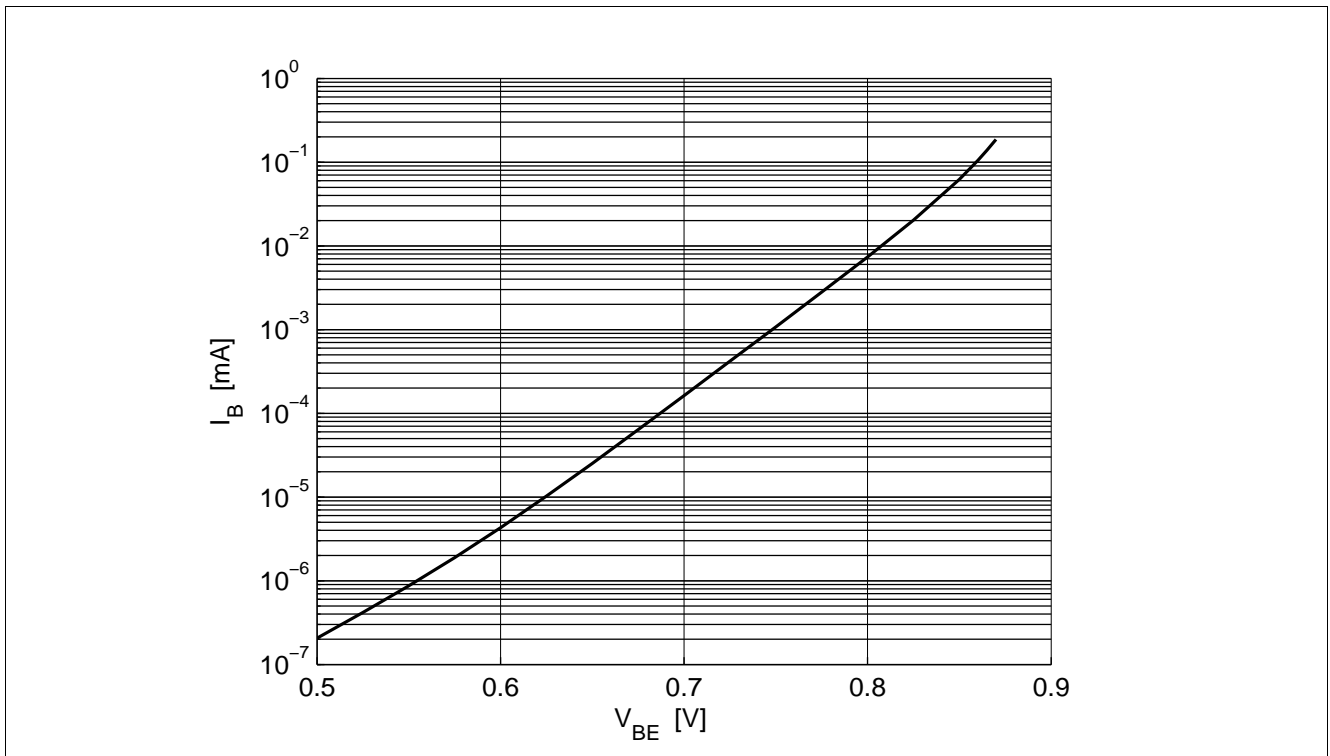

Figure 5-5 Base Current vs. Base Emitter Forward Voltage  $I_B = f(V_{BE})$ ,  $V_{CE} = 1.8$  V

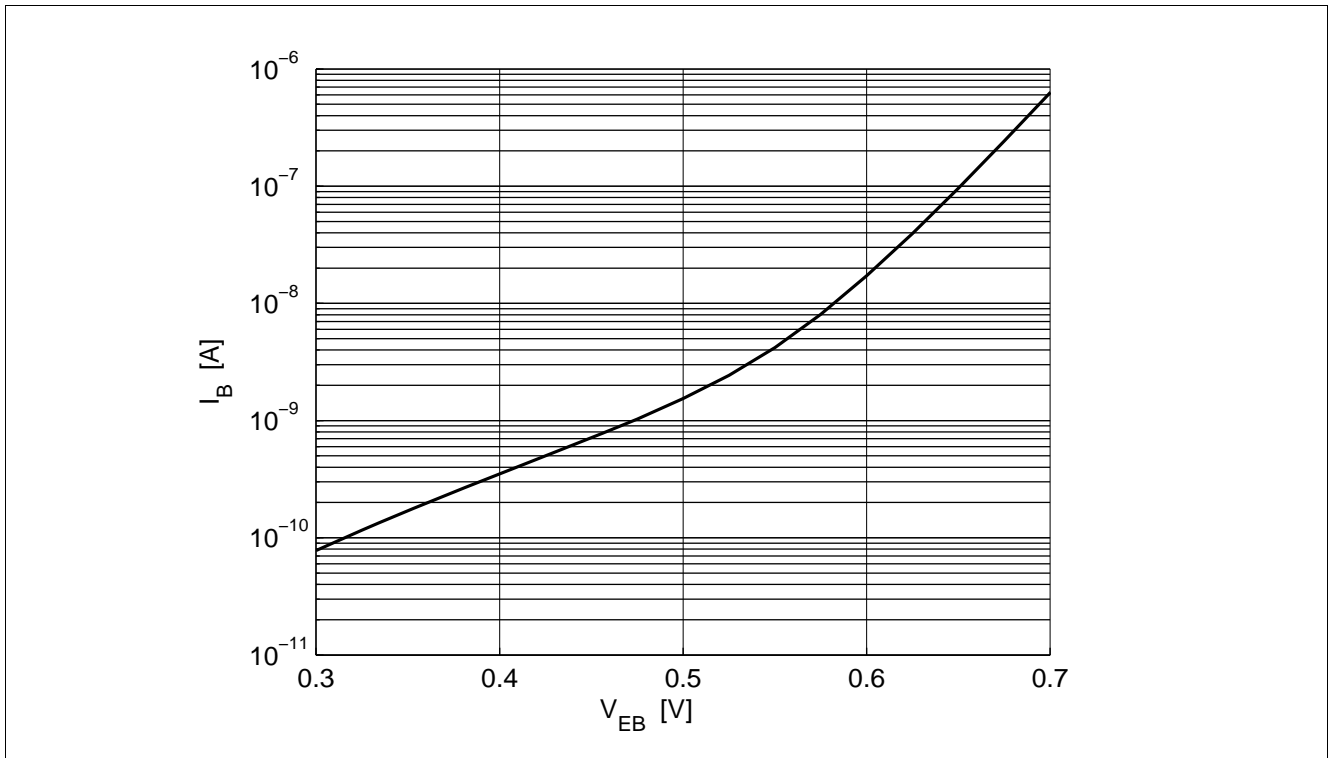

Figure 5-6 Base Current vs. Base Emitter Reverse Voltage  $I_B = f(V_{EB})$ ,  $V_{CE} = 1.8$  V

5.5 Characteristic AC Diagrams

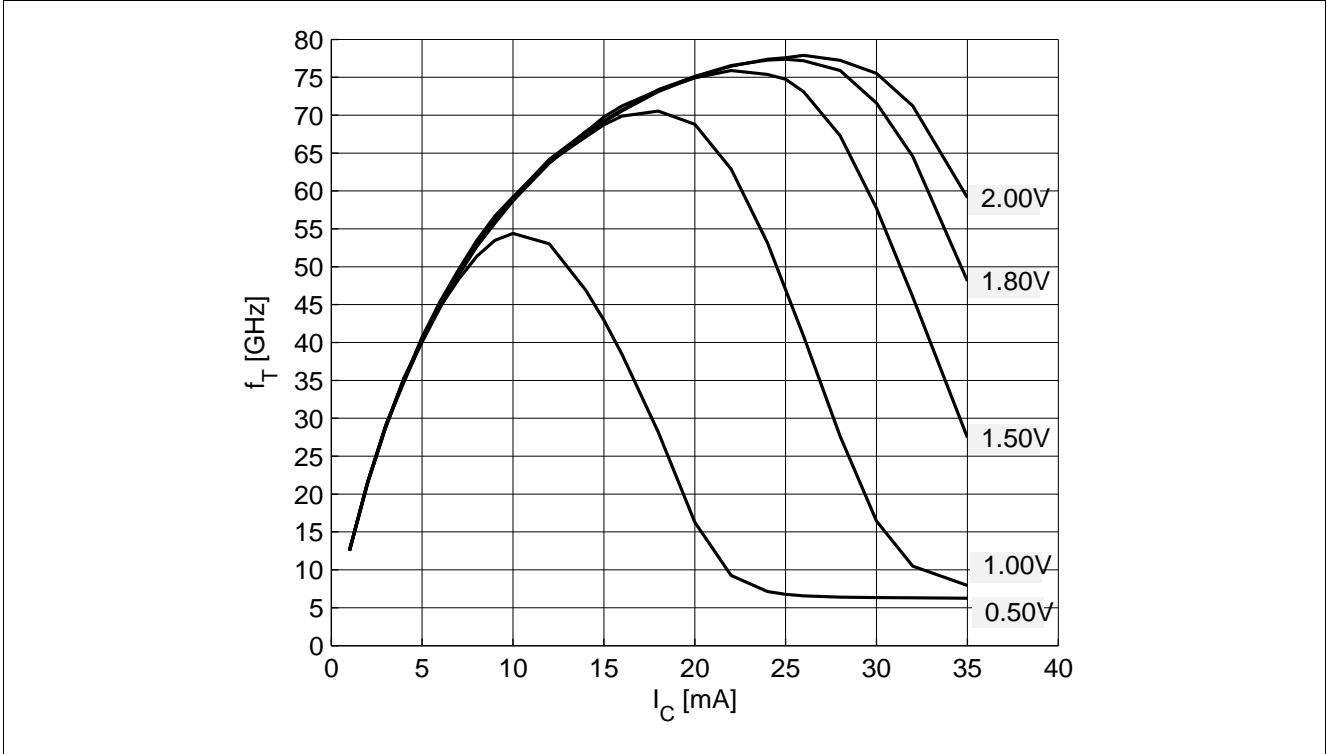

Figure 5-7 Transition Frequency  $f_T = f(I_C)$ ,  $f = 2 \text{ GHz}$ ,  $V_{CE} = \text{Parameter}$

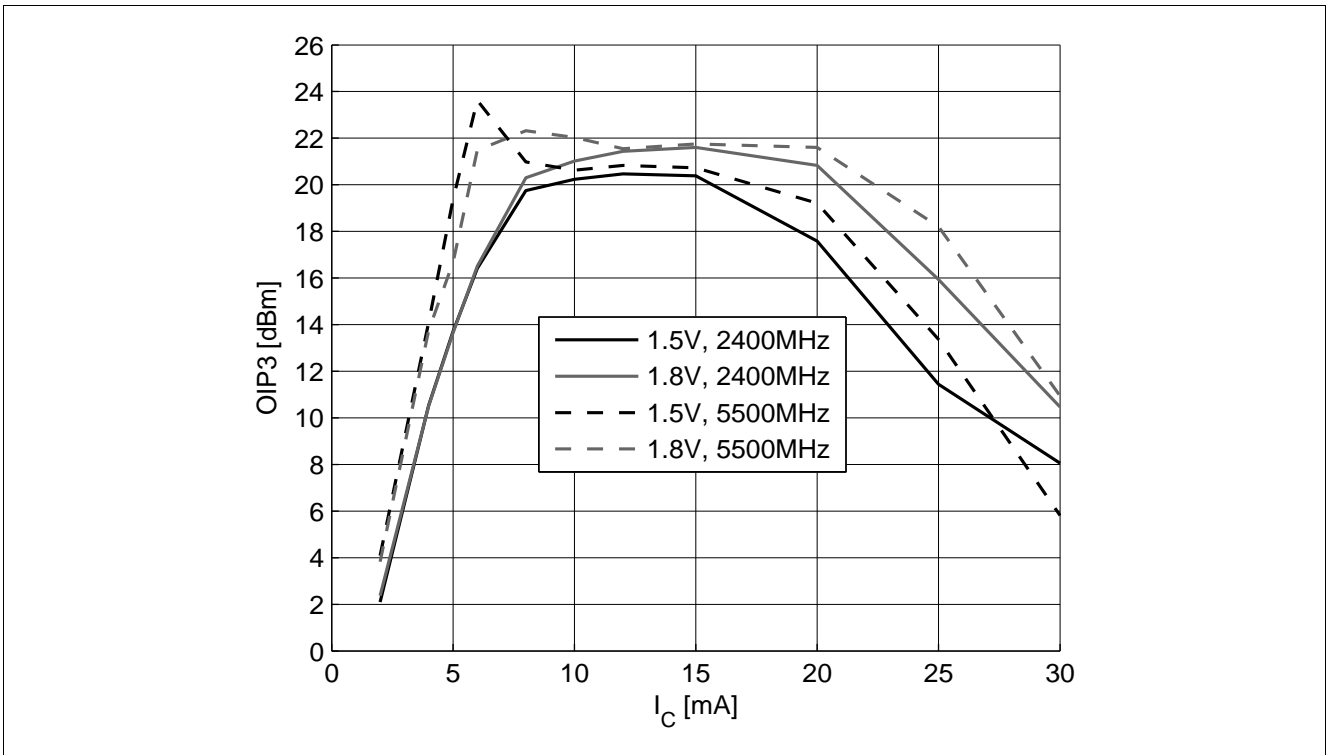

Figure 5-8 3rd Order Intercept Point at output  $OIP3 = f(I_C)$ ,  $Z_S = Z_L = 50 \Omega$ ,  $V_{CE}$ ,  $f = \text{Parameters}$

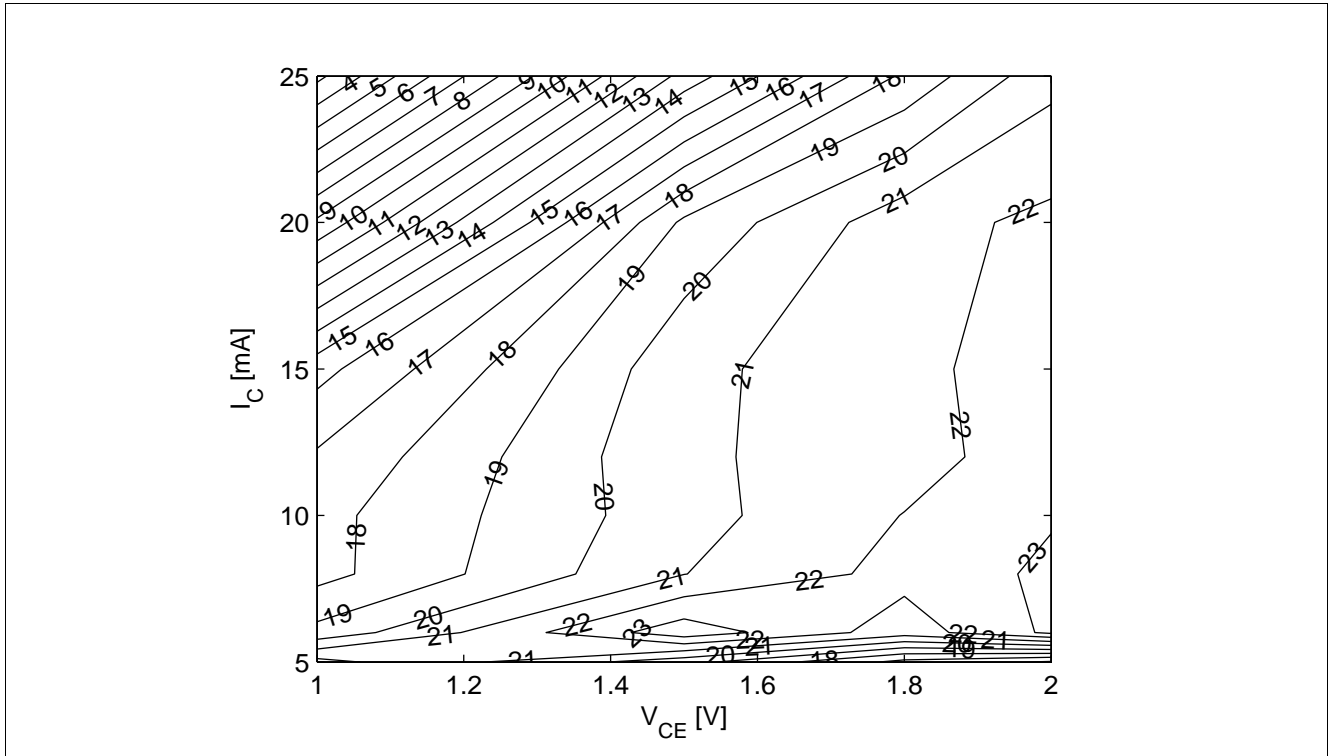

Figure 5-9 3rd Order Intercept Point at output  $OIP3 [dBm] = f(I_C, V_{CE})$ ,  $Z_S = Z_L = 50 \Omega$ ,  $f = 5.5 \text{ GHz}$

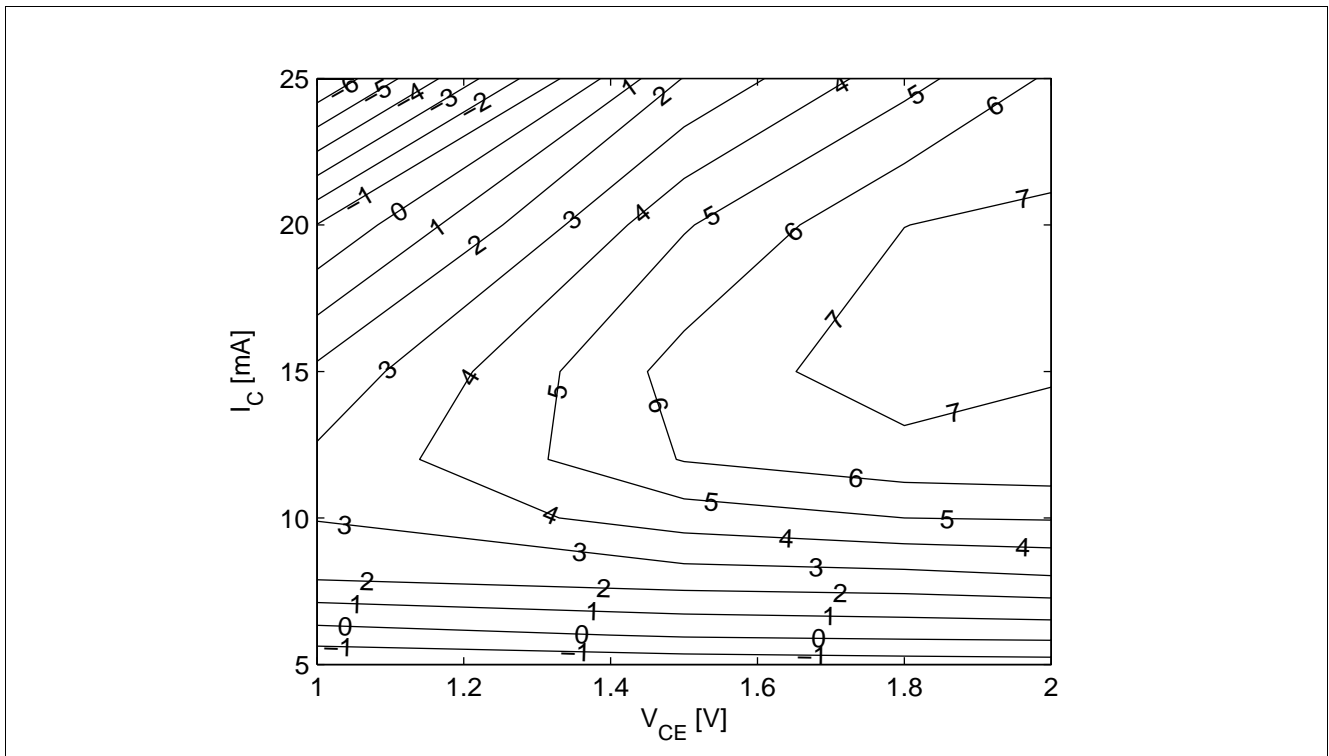

Figure 5-10 Compression Point at output  $OP_{1dB} [dBm] = f(I_C, V_{CE})$ ,  $Z_S = Z_L = 50 \Omega$ ,  $f = 5.5 \text{ GHz}$

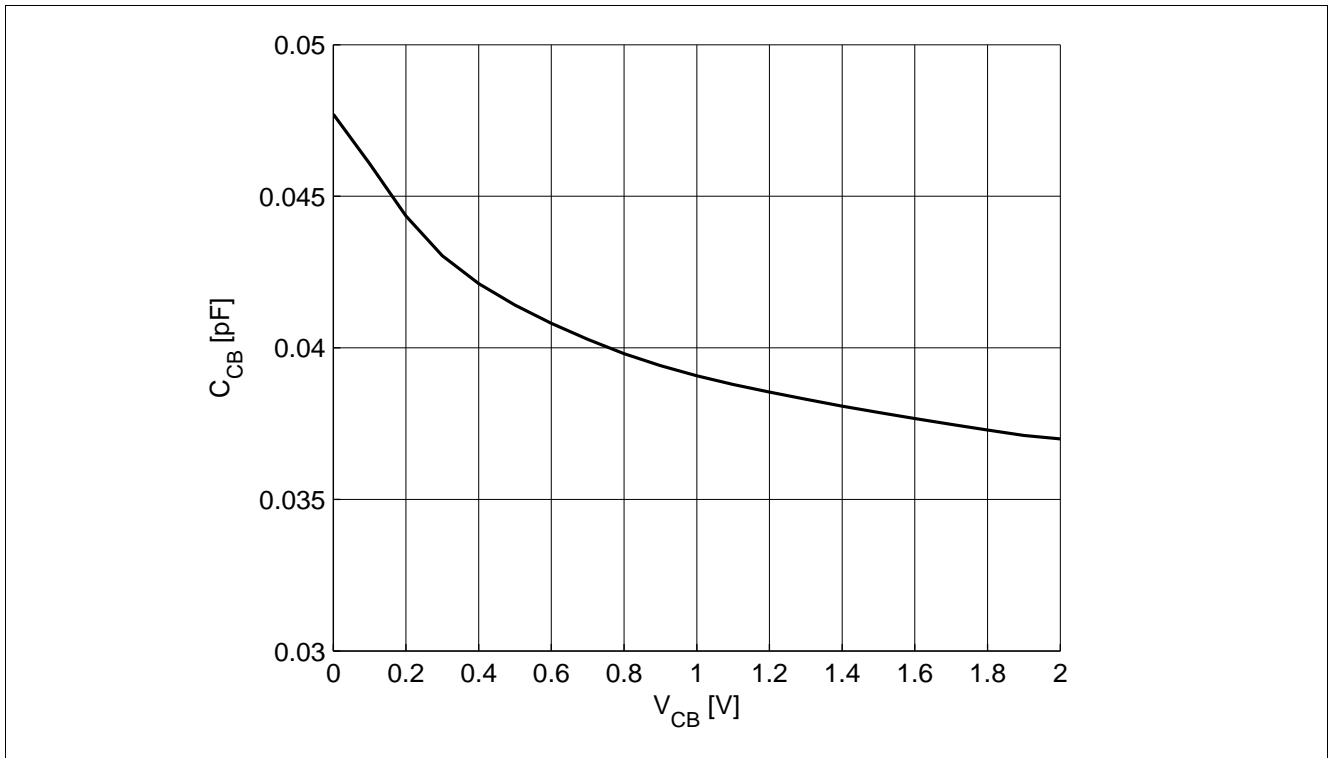

Figure 5-11 Collector Base Capacitance  $C_{CB} = f(V_{CB}), f = 1$  MHz

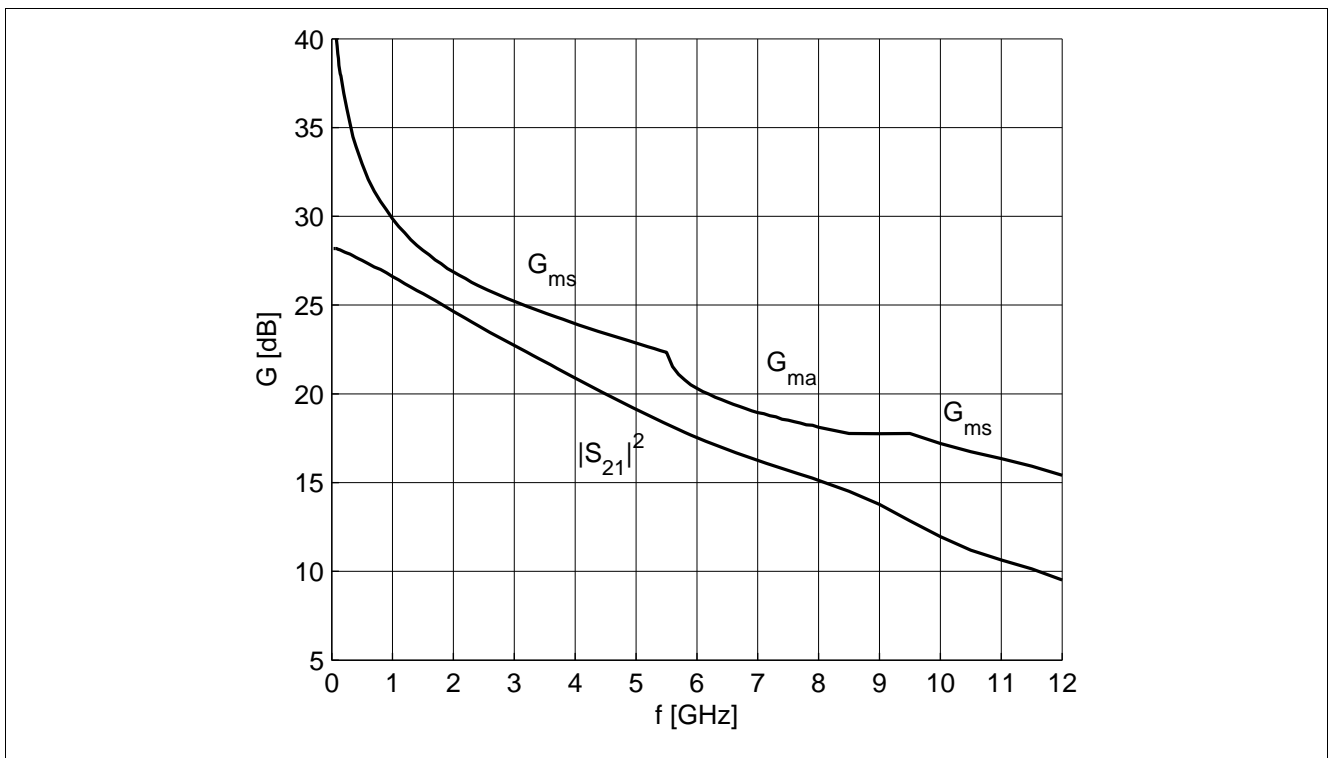

Figure 5-12 Gain  $G_{ma}, G_{ms}, |S_{21}|^2 = f(f), V_{CE} = 1.8$  V,  $I_C = 10$  mA

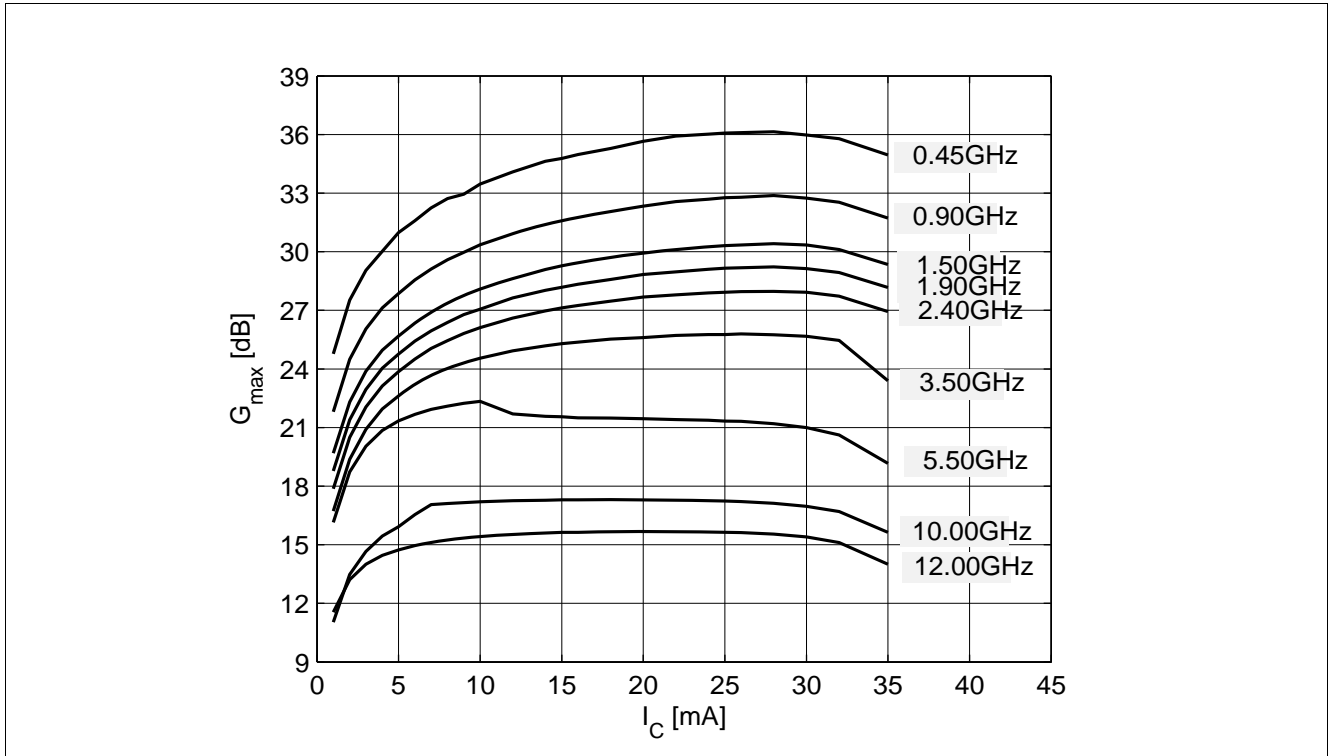

Figure 5-13 Maximum Power Gain  $G_{max} = f(I_C)$ ,  $V_{CE} = 1.8$  V,  $f =$  Parameter in GHz

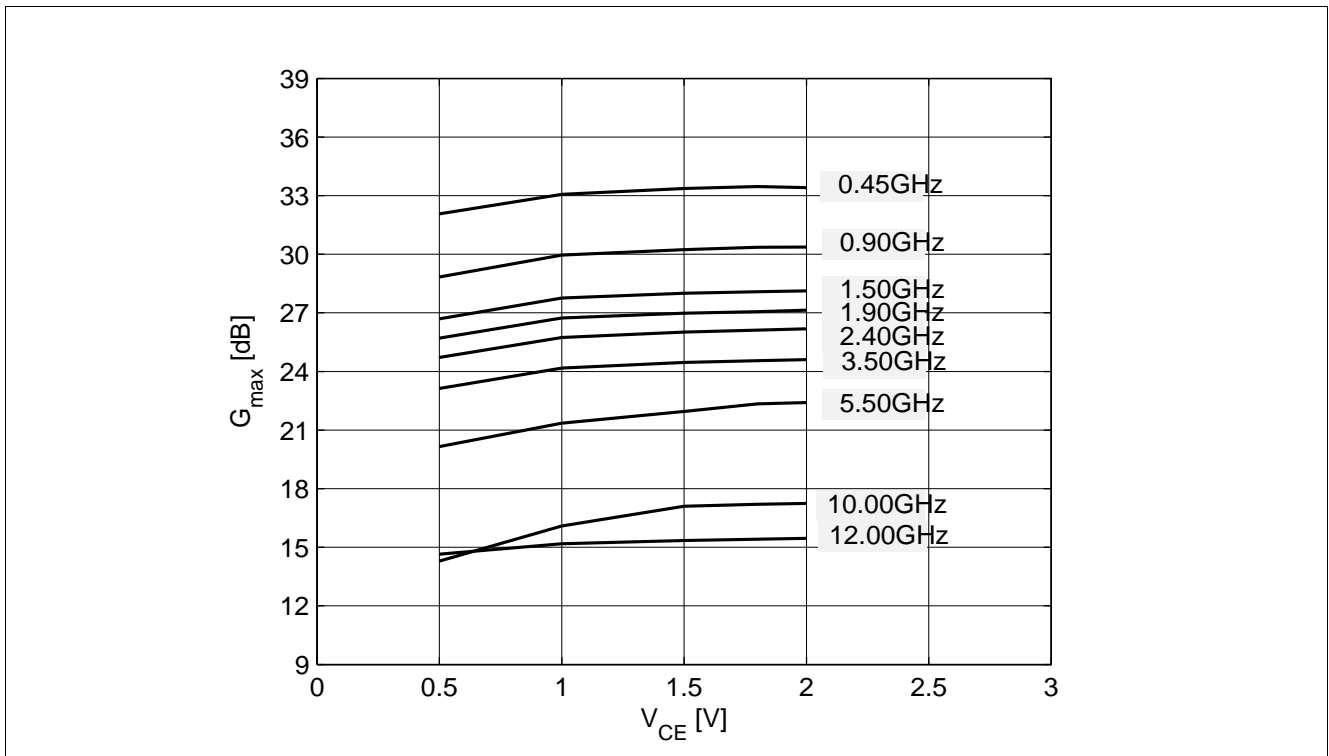

Figure 5-14 Maximum Power Gain  $G_{max} = f(V_{CE})$ ,  $I_C = 10$  mA,  $f =$  Parameter in GHz

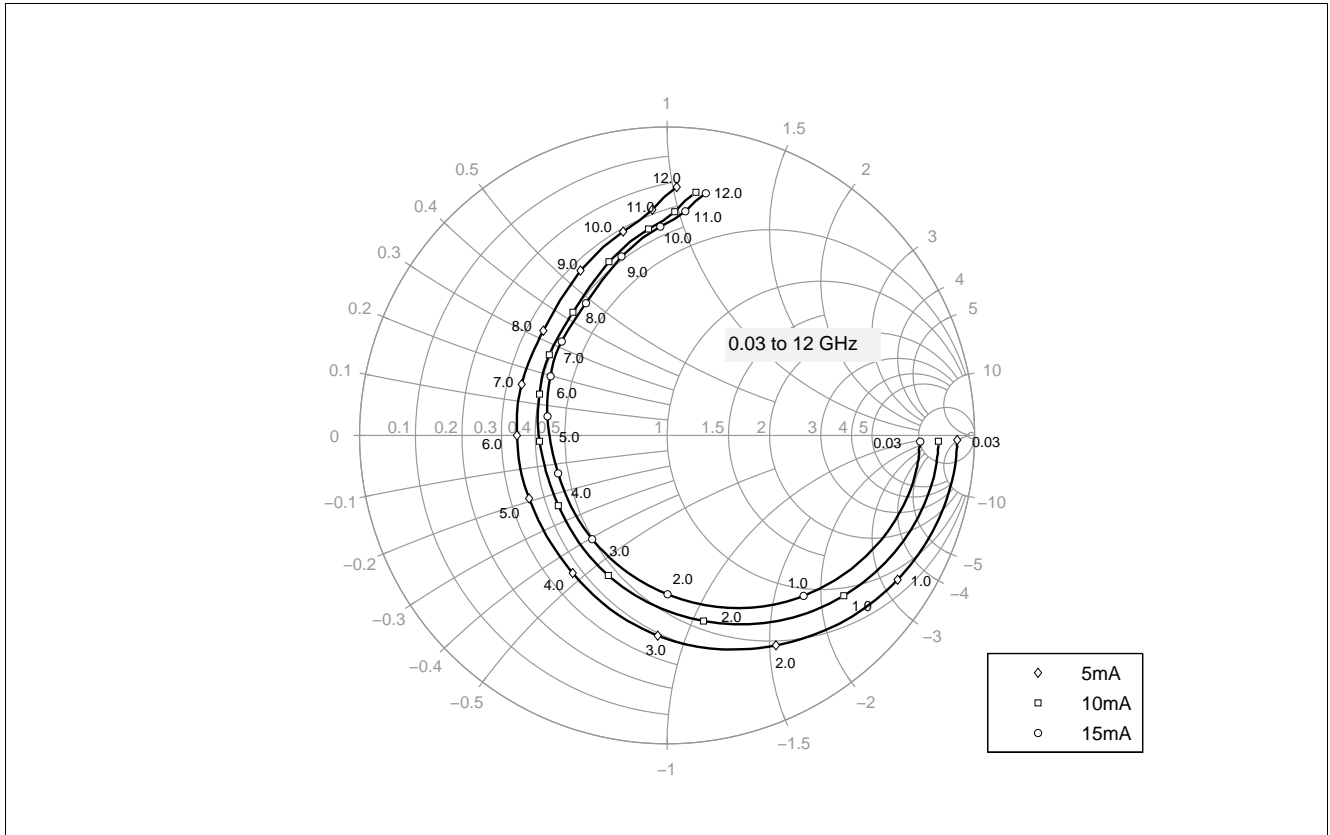

Figure 5-15 Input Reflection Coefficient  $S_{11} = f(f)$ ,  $V_{CE} = 1.8\text{ V}$ ,  $I_C = 5 / 10 / 15\text{ mA}$

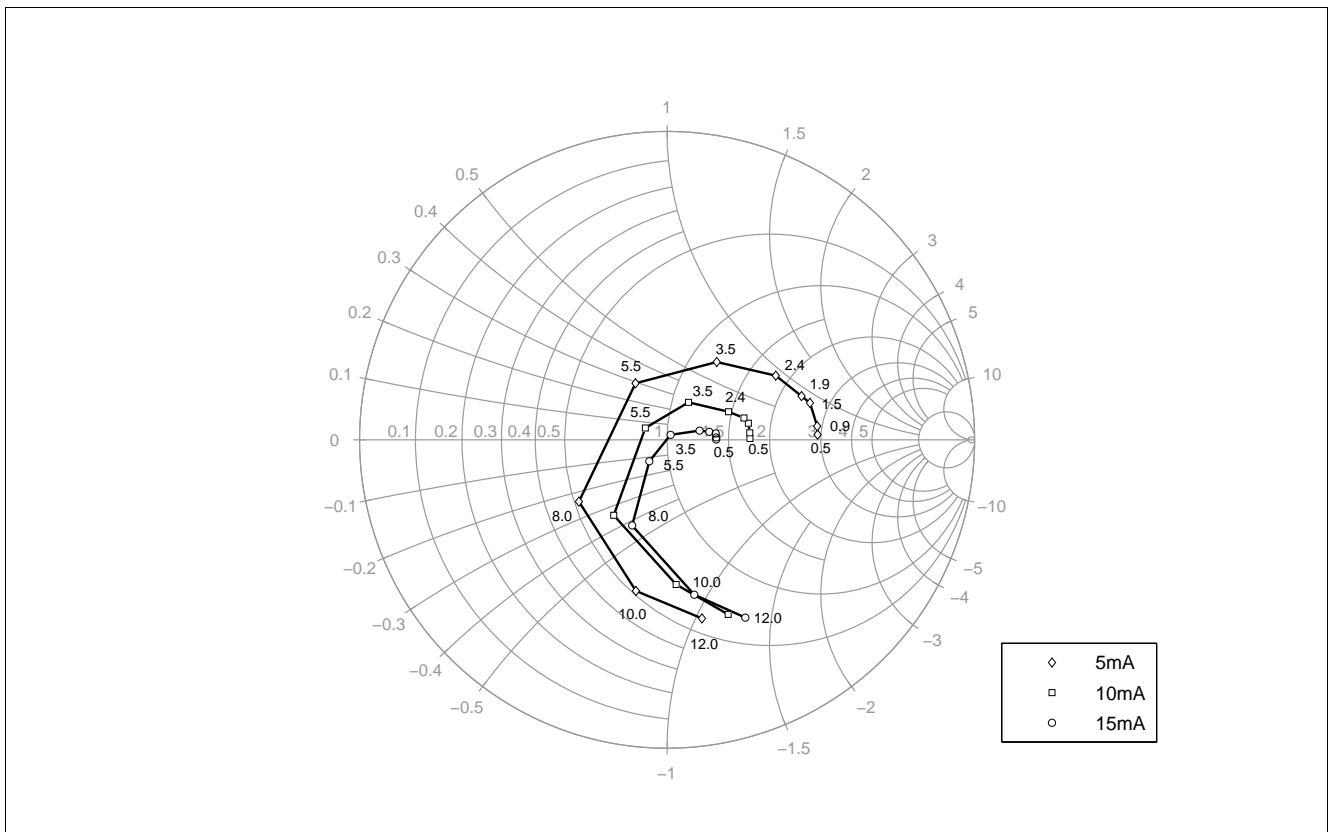

Figure 5-16 Source Impedance for Minimum Noise Figure  $Z_{opt} = f(f)$ ,  $V_{CE} = 1.8\text{ V}$ ,  $I_C = 5 / 10 / 15\text{ mA}$

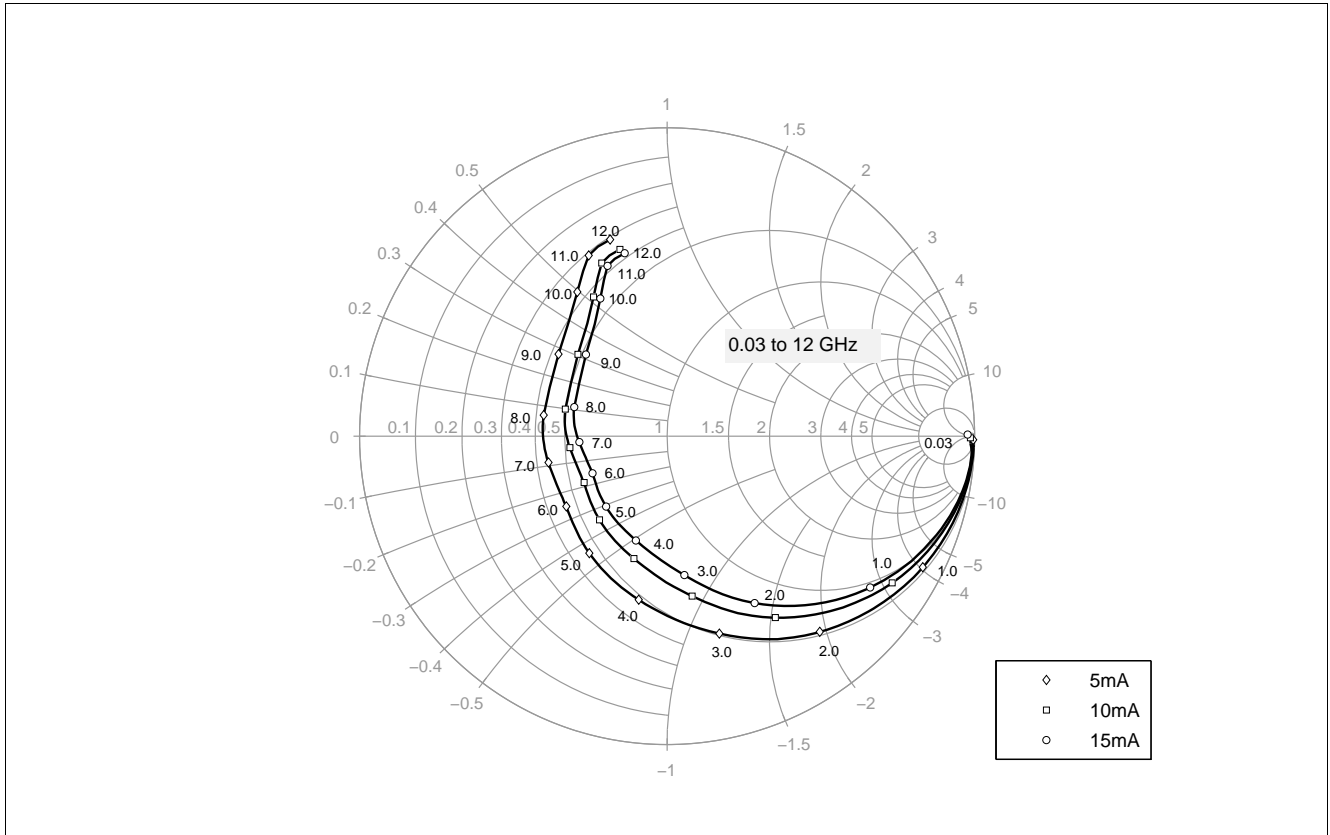

Figure 5-17 Output Reflection Coefficient  $S_{22} = f(f)$ ,  $V_{CE} = 1.8\text{ V}$ ,  $I_C = 5 / 10 / 15\text{ mA}$

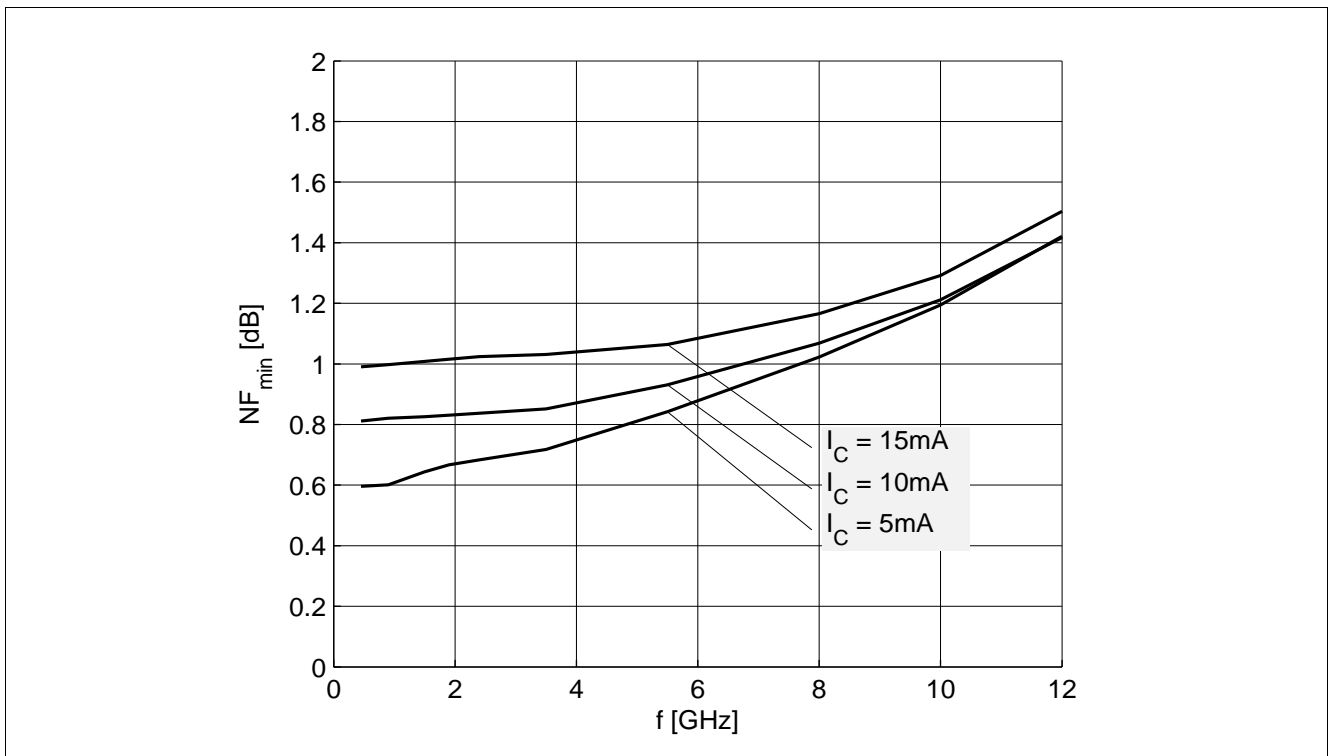

Figure 5-18 Noise Figure  $NF_{min} = f(f)$ ,  $V_{CE} = 1.8\text{ V}$ ,  $I_C = 5 / 10 / 15\text{ mA}$ ,  $Z_S = Z_{opt}$



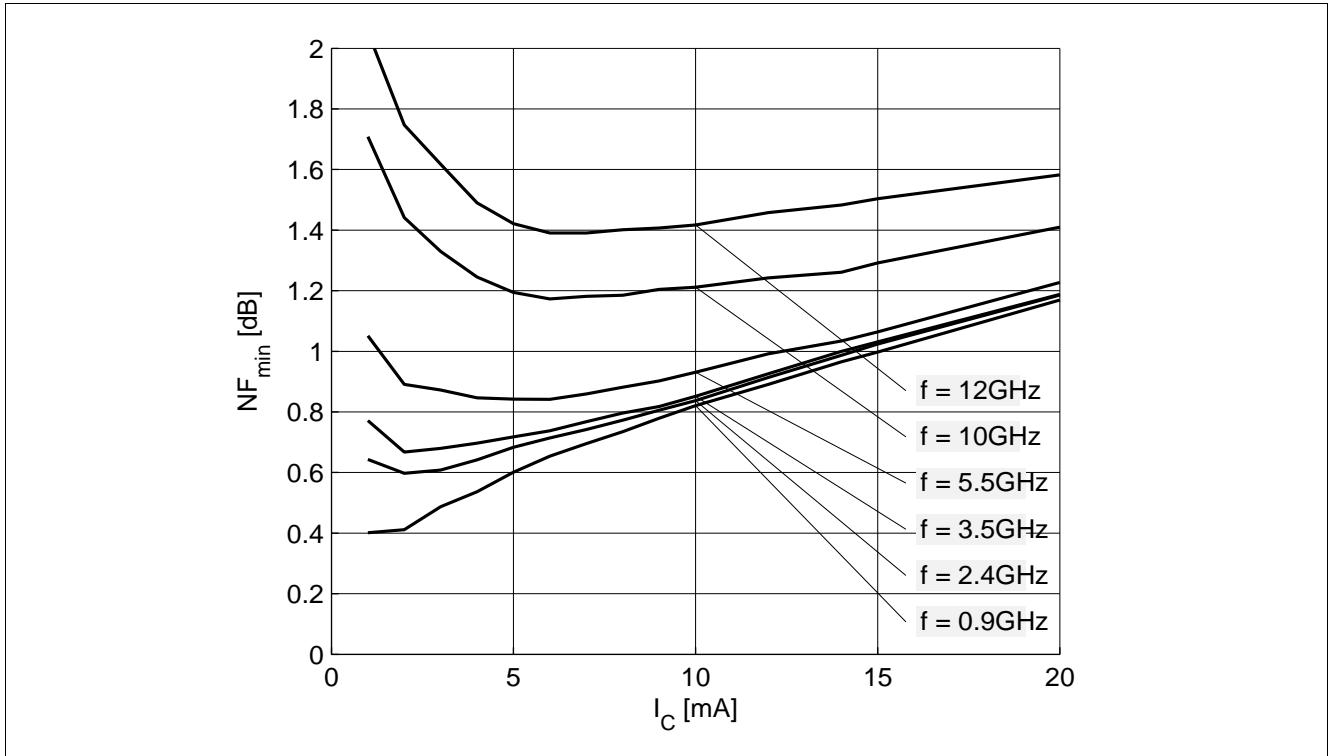

Figure 5-19 Noise Figure  $NF_{min} = f(I_C)$ ,  $V_{CE} = 1.8\text{ V}$ ,  $Z_S = Z_{opt}$ ,  $f = \text{Parameter in GHz}$

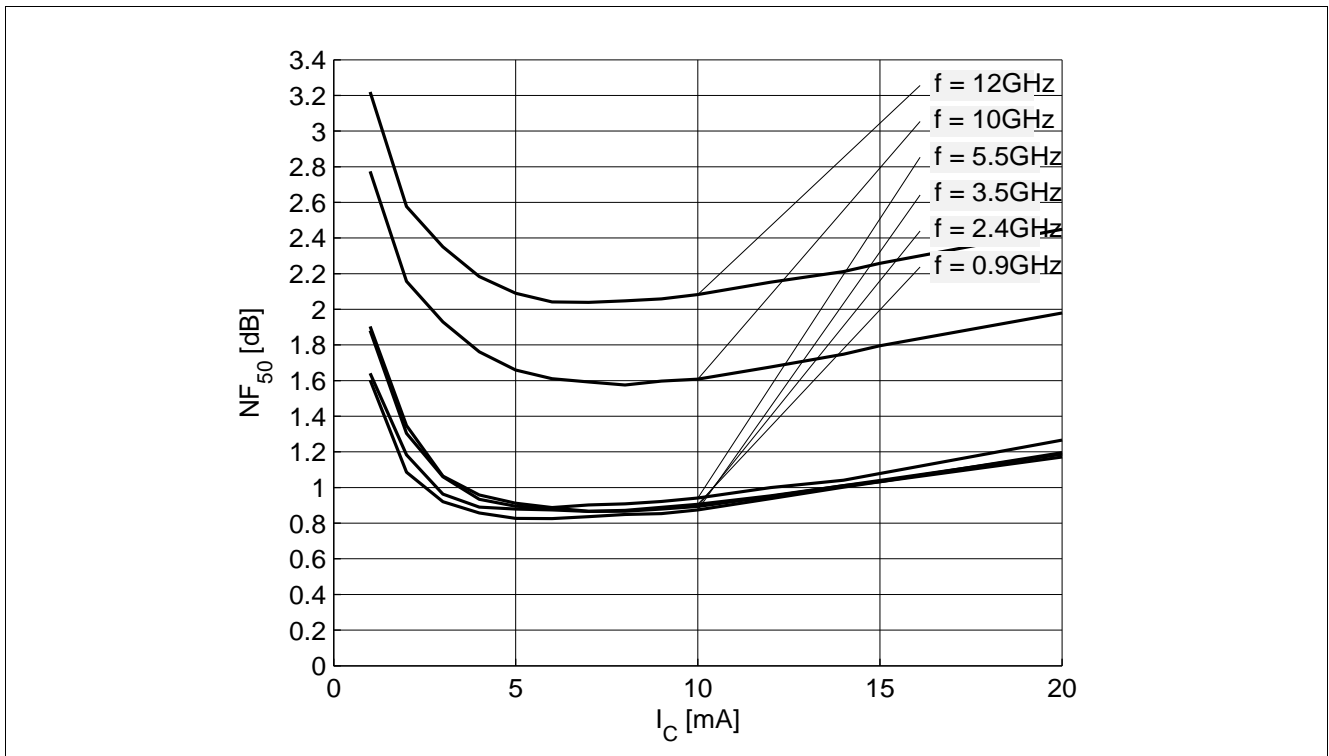

Figure 5-20 Noise Figure  $NF_{50} = f(I_C)$ ,  $V_{CE} = 1.8\text{ V}$ ,  $Z_S = 50\ \Omega$ ,  $f = \text{Parameter in GHz}$

Note: The curves shown in this chapter have been generated using typical devices but shall not be considered as a guarantee that all devices have identical characteristic curves.  $T_A = 25\text{ }^\circ\text{C}$ .

## 6 Simulation Data

For the SPICE Gummel Poon (GP) model as well as for the S-parameters (including noise parameters) please refer to our internet website. Please consult our website and download the latest versions before actually starting your design.

You find the BFP840ESD SPICE GP model in the internet in MWO- and ADS-format, which you can import into these circuit simulation tools very quickly and conveniently. The model already contains the package parasitics and is ready to use for DC and high frequency simulations. The terminals of the model circuit correspond to the pin configuration of the device.

The model parameters have been extracted and verified up to 12 GHz using typical devices. The BFP840ESD SPICE GP model reflects the typical DC- and RF-performance within the limitations which are given by the SPICE GP model itself. Besides the DC characteristics all S-parameters in magnitude and phase, as well as noise figure (including optimum source impedance, equivalent noise resistance and flicker noise) and intermodulation have been extracted.

## 7 Package Information SOT343

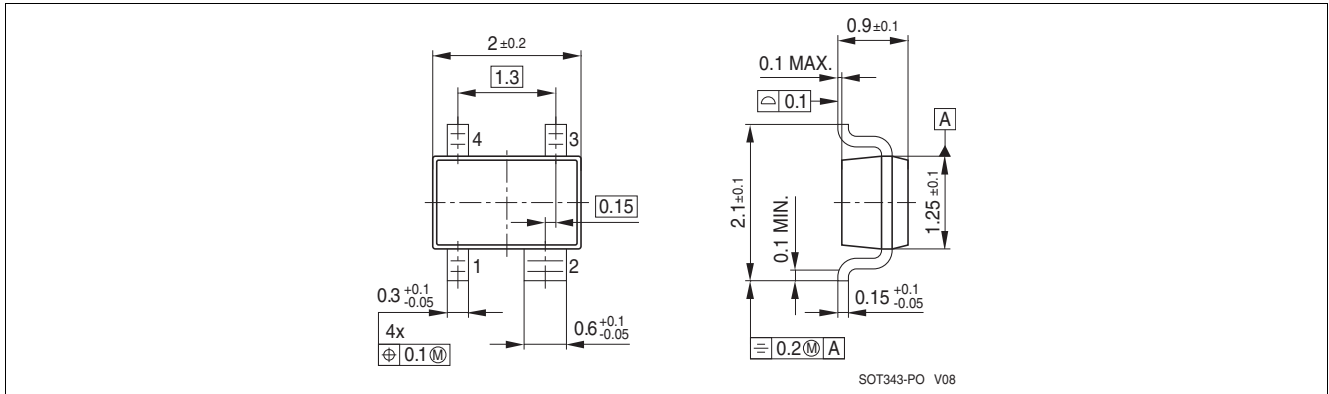

Figure 7-1 Package Outline

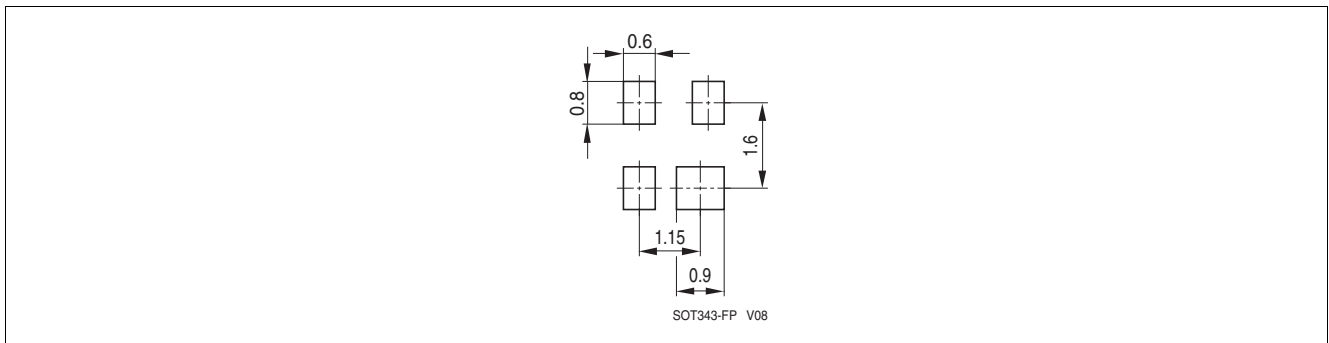

Figure 7-2 Package Footprint

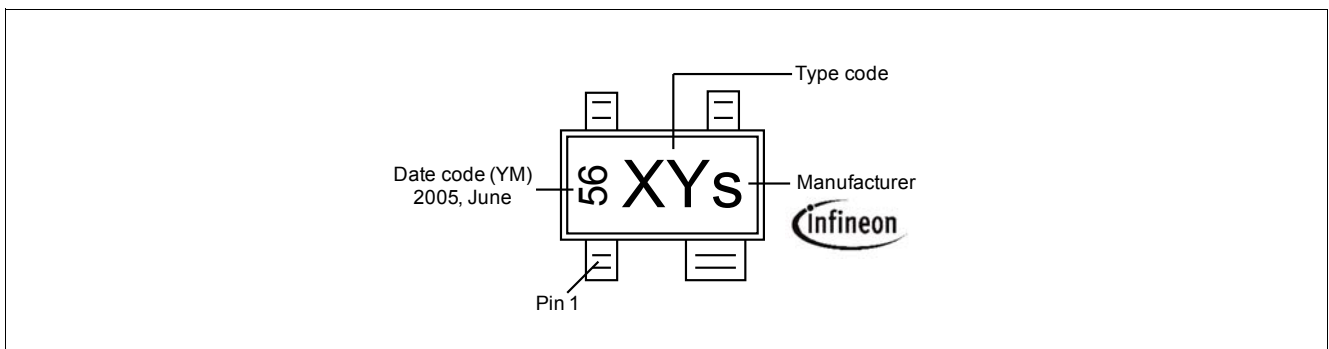

Figure 7-3 Marking Description (Marking BFP840ESD: T8s)

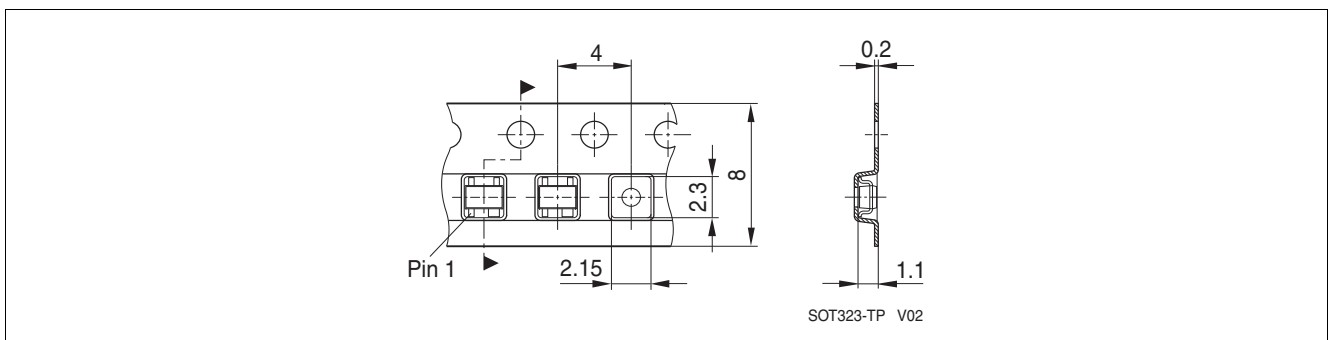

Figure 7-4 Tape Dimensions

www.infineon.com

Published by Infineon Technologies AG

Downloaded From [Oneyac.com](https://www.oneyac.com)

单击下面可查看定价，库存，交付和生命周期等信息

[>>Infineon Technologies\(英飞凌\)](#)