

THIS DRAWING IS UNPUBLISHED. RELEASED FOR PUBLICATION 2007
 © COPYRIGHT 2007 BY - ALL RIGHTS RESERVED.

LOC J DIST

REVISIONS					
P	LTR	DESCRIPTION	DATE	DWN	APVD
C1		REVISED PER ECR-12-020340	05DEC2012	E.C	H.M
C2		REVISED PER ECR-17-005500	4MAY2017	N.W.	X.X
C3		REVISED PER ECR-17-009217	24JUL2017	K.T	E.T

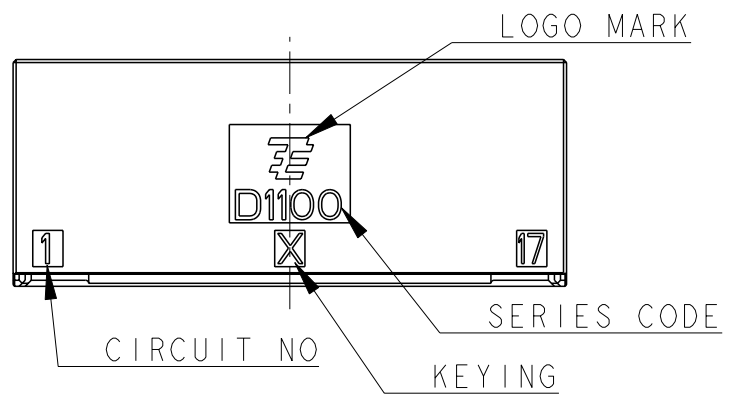
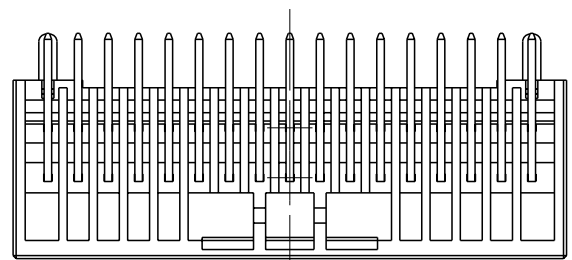
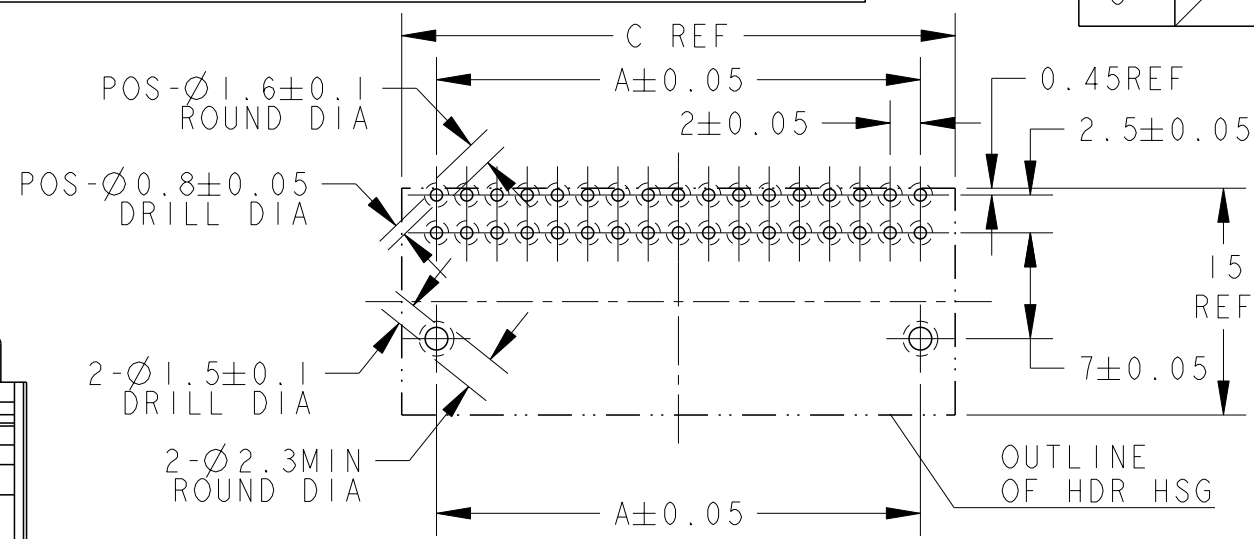

推奨基板取付寸法 : コネクタ搭載面(非累積公差)
 PC基板厚 : 1.0~1.6±0.1
 RECOMMEND PC BOARD HOLE PATTERN : CONNECTOR MOUNT SIDE
 (NOT ACCUMULATE TOLERANCE)
 PC BOARD THICKNESS : 1.0~1.6±0.1

- △1. 材料:ハウジング:ガラス入り熱可塑性ポリエステル樹脂(94V-0)、色:黒
 コンタクト:銅合金
 リテンションレグ:錫めっき済銅合金
- △2. めっき(全面):ニッケル下地めっき1.27μm以上
- △3. めっき(接触部):△2の上に金めっき0.38μm以上、またはsn1.0μm MINめっき後
- △4. めっき(コンタクト半田付部):△2の上に錫めっき2μm以上
- 5. 文字の形状、大きさ、および位置については、大略を示すものであり、詳細を示すものではありません。

- △1. MATERIAL:HOUSING:GLASS FILED THERMO PLASTIC POLYESTER(94V-0), COLOR:BLACK
 CONTACT:COPPER ALLOY
 RETENTION LEG:PRE-TIN COPPER ALLOY
- △2. FINISH(ALL OVER):NICKEL PLATING 1.27μmMIN
- △3. FINISH(CONTACT AREA):GOLD PLATING 0.38μmMIN OR Sn PLATING 1.0μmMIN AFTER △2
- △4. FINISH(CONTACT TAIL):TIN PLATING 2μmMIN AFTER △2
- 5. THE SHAPE, SIZE AND POSITION OF THE CHARACTER SHOW THE OUTLINE. THEY DON'T SHOW DETAILS.

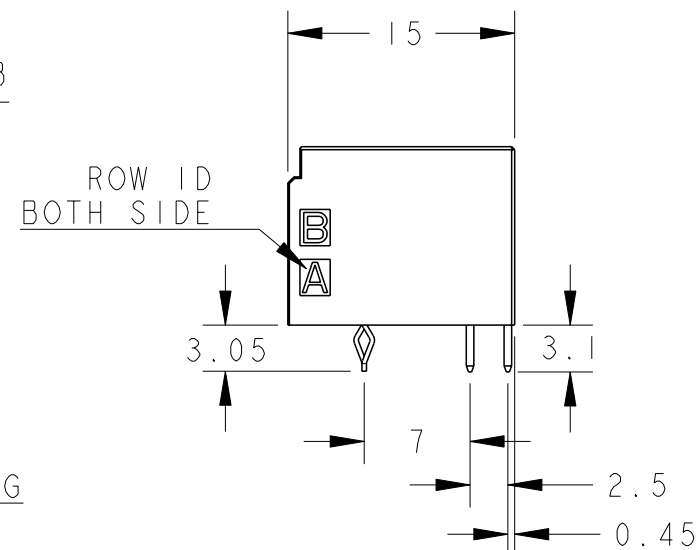
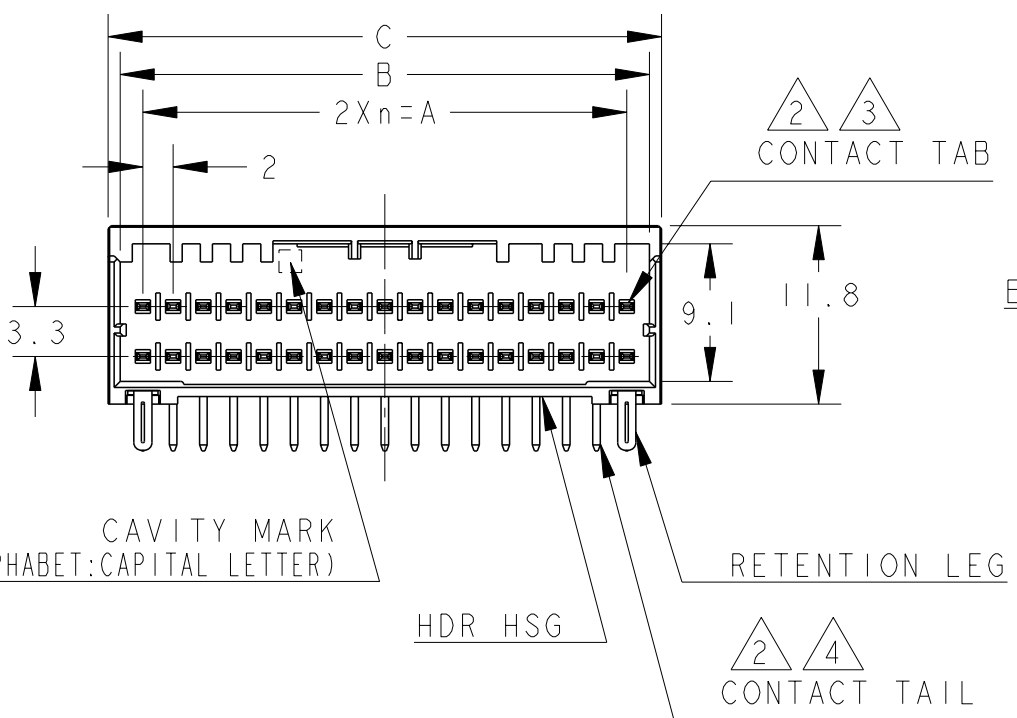

40	X	19	38.0	41.0	42.6	Sn PLATED	3-1939638-0
40	X	19	38.0	41.0	42.6	GOLD PLATED	1-1939638-0
34	X	16	32.0	35.0	36.6	Sn PLATED	3-1939638-7
34	X	16	32.0	35.0	36.6	GOLD PLATED	1-1939638-7
30	X	14	28.0	31.0	32.6	Sn PLATED	3-1939638-5
30	X	14	28.0	31.0	32.6	GOLD PLATED	1-1939638-5
28	X	13	26.0	29.0	30.6	Sn PLATED	3-1939638-4
28	X	13	26.0	29.0	30.6	GOLD PLATED	1-1939638-4
26	X	12	24.0	27.0	28.6	Sn PLATED	3-1939638-3
26	X	12	24.0	27.0	28.6	GOLD PLATED	1-1939638-3
POS	KEY	n	A	B	C	FINISHED	PART NO

34POS(X-KEY):1-1939638-7

THIS DRAWING IS A CONTROLLED DOCUMENT.

DWN M. MAEBASHI 30JUL2007
 CHK T. KUDO 30JUL2007
 APVD D. MITSUGI 30JUL2007

TE Connectivity

NAME DYNAMIC D1100D 2.0mmPITCH HDR ASSY, H-TYPE 22-40POS

PRODUCT SPEC 108-78268/78298
 APPLICATION SPEC 114-5377
 WEIGHT

SIZE A3 CAGE CODE 00779 DRAWING NO C-1939638 RESTRICTED TO

MATERIAL FINISH

Customer Drawing SCALE 2:1 SHEET 1 OF 2 REV C3

THIS DRAWING IS UNPUBLISHED.

RELEASED FOR PUBLICATION

2007

© COPYRIGHT 2007 BY -

ALL RIGHTS RESERVED.

LOC
J

DIST

REVISIONS

P	LTR	DESCRIPTION	DATE	DWN	APVD
		SEE SHEET 1 OF 2			

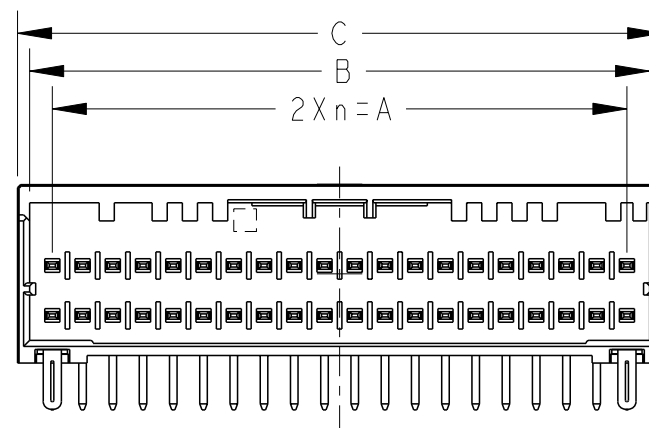
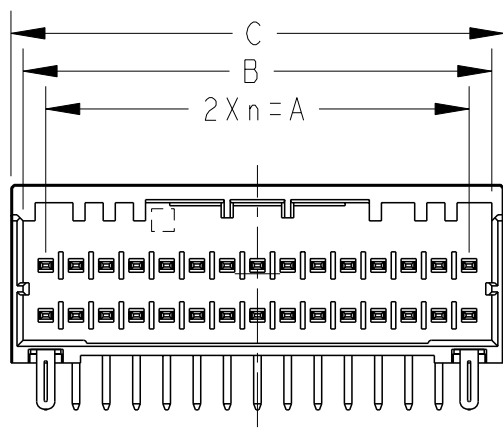
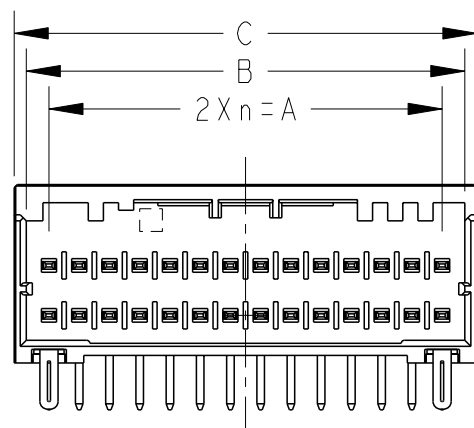
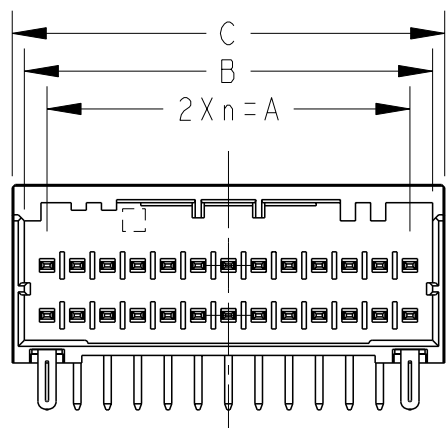
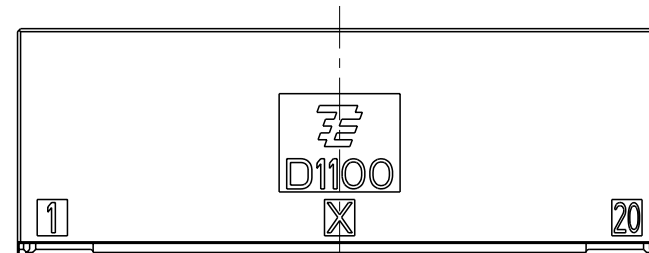
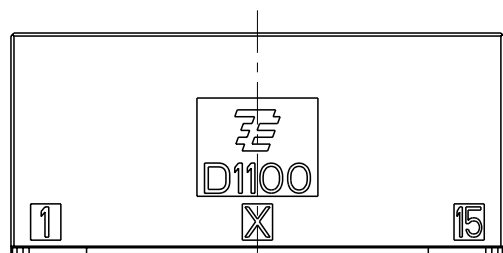
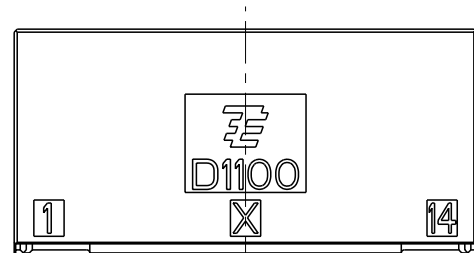
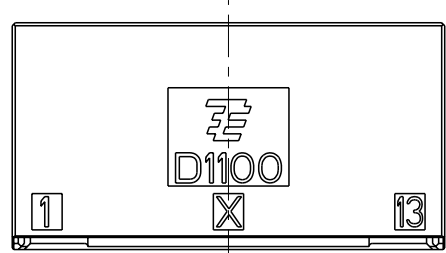
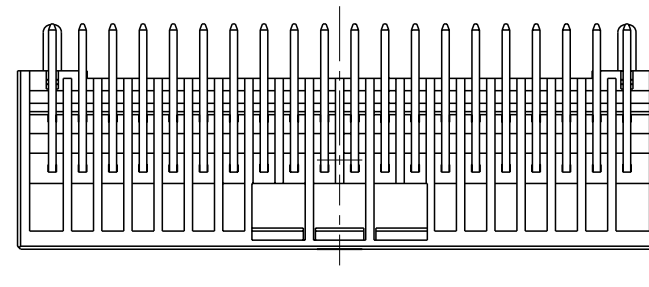
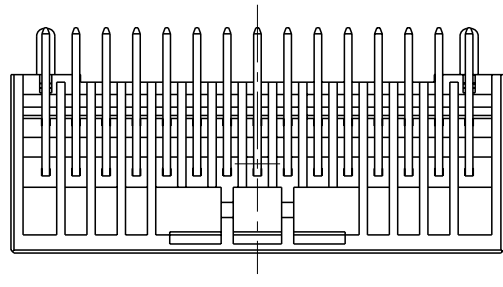
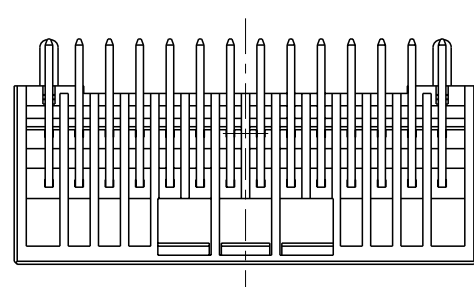
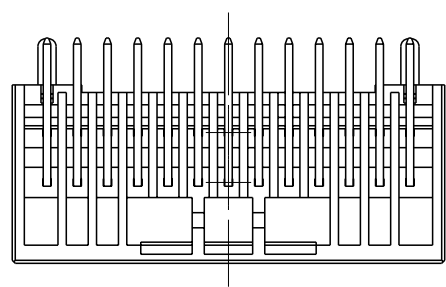

26POS(X-KEY): 1-1939638-3

28POS(X-KEY): 1-1939638-4

30POS(X-KEY): 1-1939638-5

40POS(X-KEY): 1-1939638-0

THIS DRAWING IS A CONTROLLED DOCUMENT.

DIMENSIONS:
mm

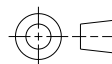

TOLERANCES UNLESS OTHERWISE SPECIFIED:

0 PLC	±
1 PLC	±0.5
2 PLC	±0.13
3 PLC	±0.013
4 PLC	±0.0001
ANGLES	±

MATERIAL

FINISH

DWN	M. MAEBASHI	30 JUL 2007
CHK	T. KUDO	30 JUL 2007
APVD	D. MITSUGI	30 JUL 2007
PRODUCT SPEC	108-78268/78298	
APPLICATION SPEC	114-5377	
WEIGHT	-	



TE Connectivity

NAME
DYNAMIC D1100D 2.0mmPITCH
HDR ASSY, H-TYPE
22-40POS

SIZE	CAGE CODE	DRAWING NO	RESTRICTED TO
A3	00779	C-1939638	-

Customer Drawing

SCALE 2:1

SHEET 2 OF 2

REV C3

单击下面可查看定价，库存，交付和生命周期等信息

[>>TE Connectivity\(泰科\)](#)