

## Automotive-grade N-channel 30 V, 0.0045 $\Omega$ typ, 80 A STripFET H5 Power MOSFET in a DPAK package

Datasheet - production data

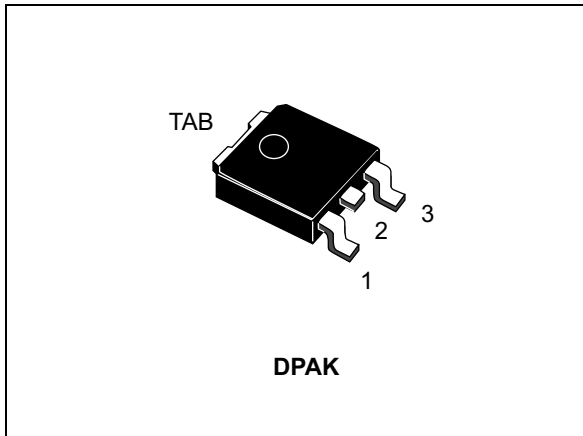

### Features

Order code	$V_{DSS}$	$R_{DS(on) \max}$	$I_D$
STD86N3LH5	30 V	< 0.005 $\Omega$	80 A

- Designed for automotive applications and AEC-Q101 qualified
- Low on-resistance  $R_{DS(on)}$
- High avalanche ruggedness
- Low gate drive power losses

### Application

- Switching applications

### Description

This device is an N-channel Power MOSFET developed using STMicroelectronics' STripFET™ H5 technology. The device has been optimized to achieve very low on-state resistance, contributing to a FoM that is among the best in its class.

Figure 1. Internal schematic diagram

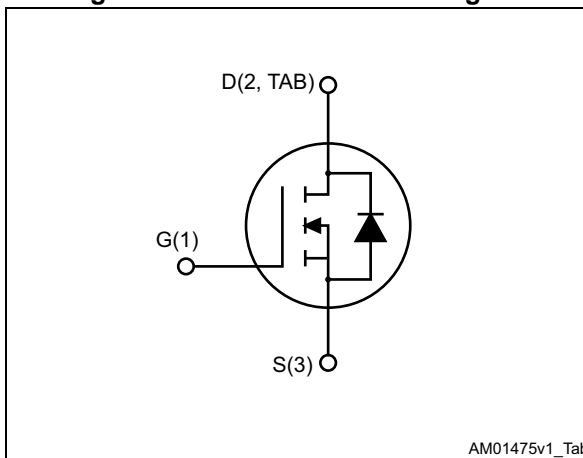

Table 1. Device summary

Order code	Marking	Package	Packaging
STD86N3LH5	86N3LH5	DPAK	Tape and reel

# Contents

<b>1</b>	<b>Electrical ratings</b> .....	<b>3</b>
<b>2</b>	<b>Electrical characteristics</b> .....	<b>4</b>
2.1	Electrical characteristics (curves) .....	6
<b>3</b>	<b>Test circuit</b> .....	<b>8</b>
<b>4</b>	<b>Package information</b> .....	<b>10</b>
<b>5</b>	<b>Packing information</b> .....	<b>14</b>
<b>6</b>	<b>Revision history</b> .....	<b>16</b>



# 1 Electrical ratings

**Table 2. Absolute maximum ratings**

Symbol	Parameter	Value	Unit
$V_{DS}$	Drain-source voltage ( $V_{GS} = 0$ V)	30	V
$V_{DS}$	Drain-source voltage ( $V_{GS} = 0$ V) @ $T_{JMAX}$	35	V
$V_{GS}$	Gate-source voltage	$\pm 20$	V
$I_D^{(1)}$	Drain current (continuous) at $T_C = 25$ °C	80	A
$I_D$	Drain current (continuous) at $T_C = 100$ °C	55	A
$I_{DM}^{(2)}$	Drain current (pulsed)	320	A
$P_{TOT}$	Total dissipation at $T_C = 25$ °C	70	W
	Derating factor	0.47	W/°C
$E_{AS}^{(3)}$	Single pulse avalanche energy	165	mJ
$T_{stg}$	Storage temperature	-55 to 175	°C
$T_j$	Max. operating junction temperature	175	°C

1. Limited by wire bonding
2. Pulse width limited by safe operating area
3. Starting  $T_j = 25$ °C,  $I_D = 40$  A,  $V_{DD} = 25$  V

**Table 3. Thermal resistance**

Symbol	Parameter	Value	Unit
$R_{thj-case}$	Thermal resistance junction-case max	2.14	°C/W
$R_{thj-pcb}^{(1)}$	Thermal resistance junction-pcb max	50	°C/W

1. When mounted on 1 inch<sup>2</sup> FR-4 Oz Cu board

## 2 Electrical characteristics

( $T_{CASE} = 25\text{ °C}$  unless otherwise specified)

**Table 4. Static**

Symbol	Parameter	Test conditions	Min.	Typ.	Max.	Unit
$V_{(BR)DSS}$	Drain-source breakdown Voltage	$I_D = 250\ \mu\text{A}$ , $V_{GS} = 0\ \text{V}$	30	-	-	V
$I_{DSS}$	Zero gate voltage drain current ( $V_{GS} = 0\ \text{V}$ )	$V_{DS} = 20\ \text{V}$ $V_{DS} = 20\ \text{V}$ , $T_c = 125\text{ °C}$	-	-	1 10	$\mu\text{A}$ $\mu\text{A}$
$I_{GSS}$	Gate body leakage current ( $V_{DS} = 0\ \text{V}$ )	$V_{GS} = \pm 20\ \text{V}$	-	-	$\pm 100$	nA
$V_{GS(th)}$	Gate threshold voltage	$V_{DS} = V_{GS}$ , $I_D = 250\ \mu\text{A}$	1	1.8	2.5	V
$R_{DS(on)}$	Static drain-source on-resistance	$V_{GS} = 10\ \text{V}$ , $I_D = 40\ \text{A}$	-	0.0045	0.005	$\Omega$
		$V_{GS} = 5\ \text{V}$ , $I_D = 40\ \text{A}$	-	0.0055	0.0065	$\Omega$

**Table 5. Dynamic**

Symbol	Parameter	Test conditions	Min.	Typ.	Max.	Unit
$C_{iss}$	Input capacitance	$V_{DS} = 25\ \text{V}$ , $f = 1\ \text{MHz}$ , $V_{GS} = 0\ \text{V}$	-	1850	-	pF
$C_{oss}$	Output capacitance		-	380	-	pF
$C_{rss}$	Reverse transfer capacitance		-	58	-	pF
$Q_g$	Total gate charge	$V_{DD} = 15\ \text{V}$ , $I_D = 80\ \text{A}$ $V_{GS} = 5\ \text{V}$ <i>Figure 16</i>	-	14	-	nC
$Q_{gs}$	Gate-source charge		-	6.8	-	nC
$Q_{gd}$	Gate-drain charge		-	4.7	-	nC
$Q_{gs1}$	Pre $V_{th}$ gate-to-source charge	$V_{DD} = 15\ \text{V}$ , $I_D = 80\ \text{A}$ $V_{GS} = 5\ \text{V}$ <i>Figure 16</i>	-	2.3	-	nC
$Q_{gs2}$	Post $V_{th}$ gate-to-source charge		-	4.5	-	nC
$R_G$	Gate input resistance	$f = 1\ \text{MHz}$ gate bias Bias = 0 test signal level = 20 mV, open drain	-	1.2	-	$\Omega$

Table 6. Switching on/off (inductive load)

Symbol	Parameter	Test conditions	Min.	Typ.	Max.	Unit
$t_{d(on)}$	Turn-on delay time	$V_{DD} = 15\text{ V}$ , $I_D = 40\text{ A}$ , $R_G = 4.7\ \Omega$ , $V_{GS} = 5\text{ V}$ <i>Figure 15</i>	-	6	-	ns
$t_r$	Rise time		-	14	-	ns
$t_{d(off)}$	Turn-off delay time		-	23.6	-	ns
$t_f$	Fall time		-	10.8	-	ns

Table 7. Source drain diode

Symbol	Parameter	Test conditions	Min.	Typ.	Max.	Unit
$I_{SD}$	Source-drain current		-		80	A
$I_{SDM}^{(1)}$	Source-drain current (pulsed)				320	A
$V_{SD}^{(2)}$	Forward on voltage	$I_{SD} = 40\text{ A}$ , $V_{GS} = 0$	-		1.1	V
$t_{rr}$	Reverse recovery time	$I_{SD} = 80\text{ A}$ , $di/dt = 100\text{ A}/\mu\text{s}$ , $V_{DD} = 20\text{ V}$ <i>Figure 17</i>	-	31.8		ns
$Q_{rr}$	Reverse recovery charge		-	26.1		nC
$I_{RRM}$	Reverse recovery current		-	1.6		A

1. Pulse width limited by safe operating area
2. Pulsed: pulse duration = 300  $\mu\text{s}$ , duty cycle 1.5%

## 2.1 Electrical characteristics (curves)

Figure 2. Safe operating area

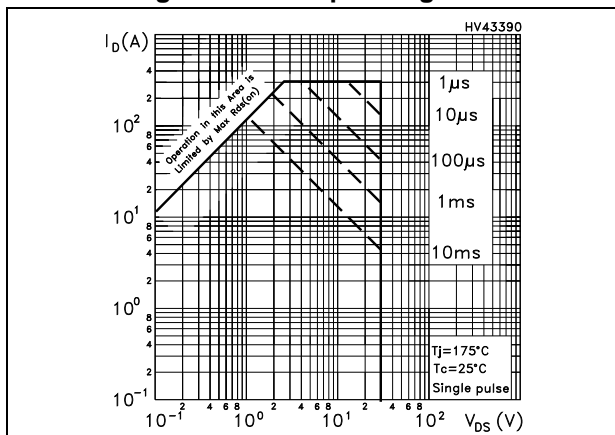

Figure 3. Thermal impedance

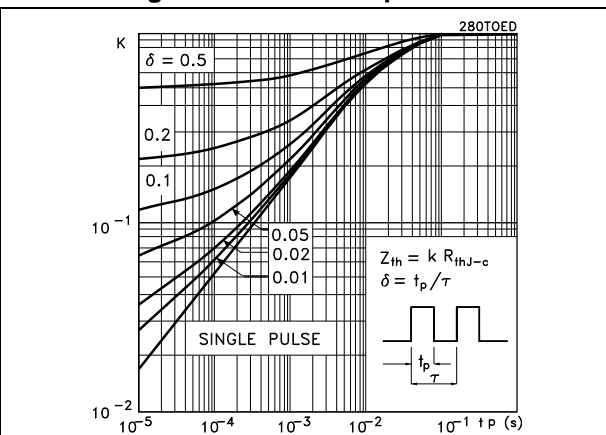

Figure 4. Output characteristics

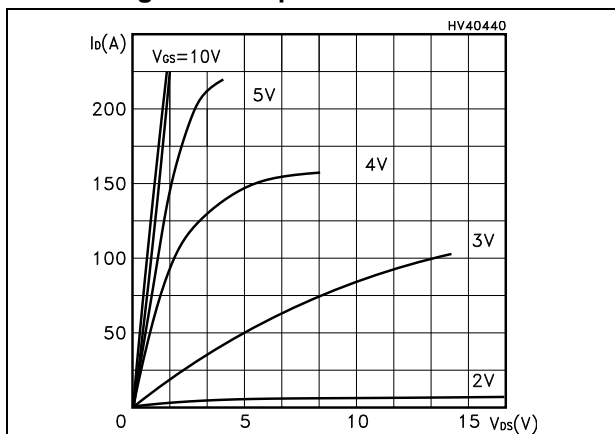

Figure 5. Transfer characteristics

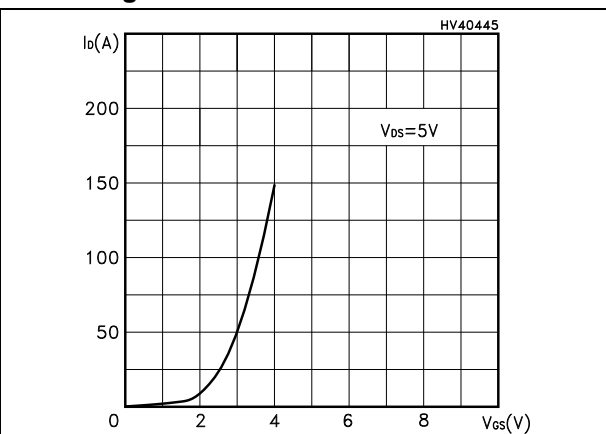

Figure 6. Normalized B<sub>VDS</sub> vs temperature

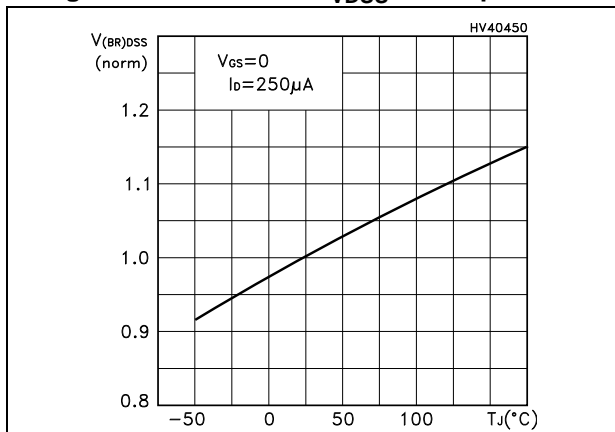

Figure 7. Static drain-source on resistance

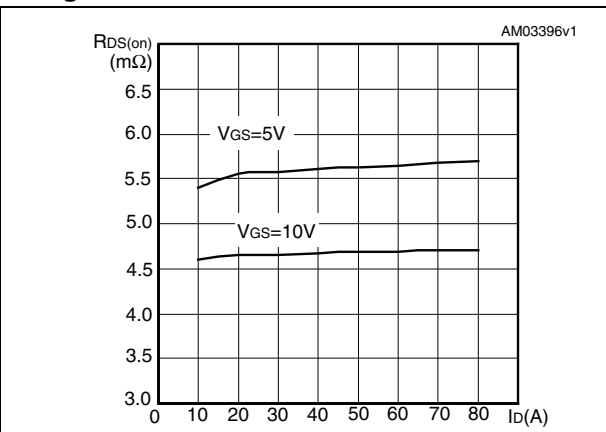

Figure 8. Gate charge vs gate-source voltage

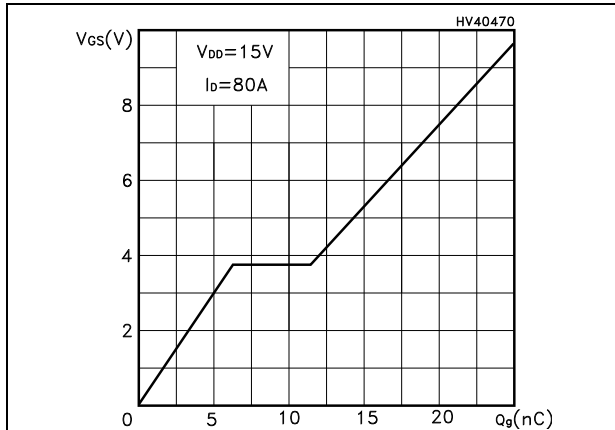

Figure 9. Capacitance variations

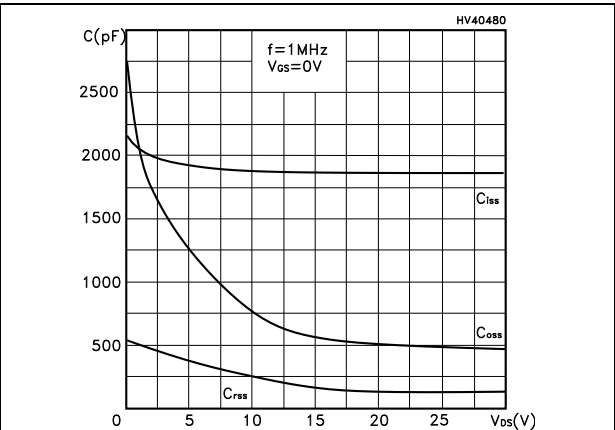

Figure 10. Normalized gate threshold voltage vs temperature

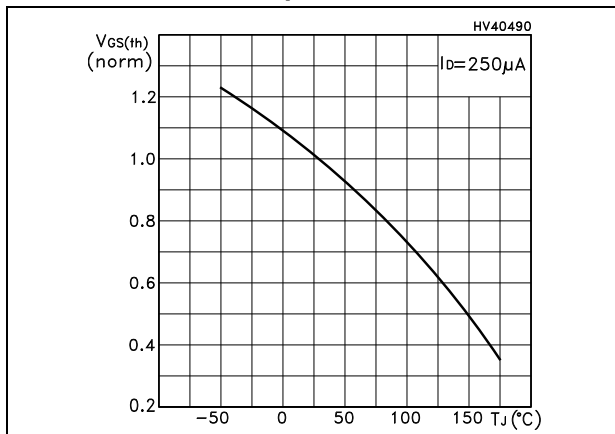

Figure 11. Normalized on resistance vs temperature

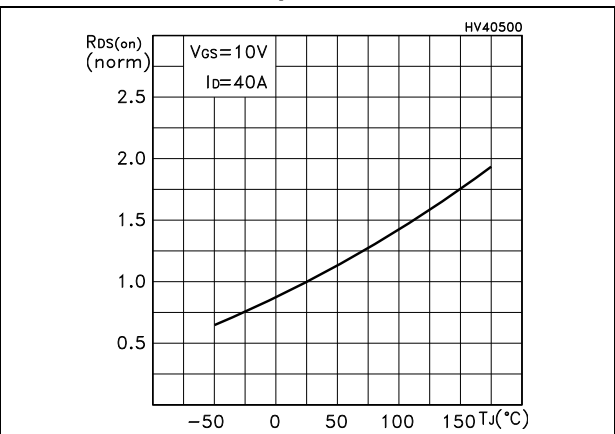
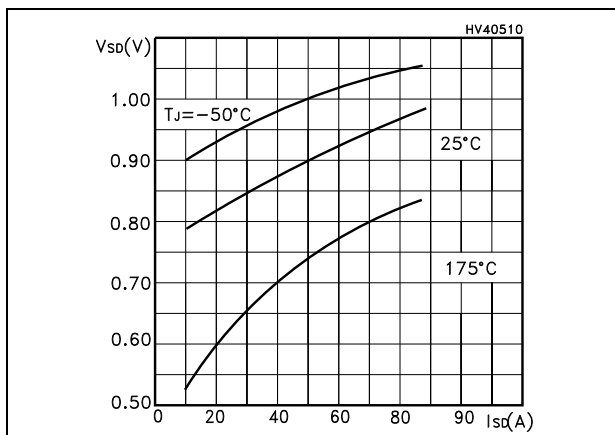

Figure 12. Source-drain diode forward characteristics



### 3 Test circuit

Figure 13. Switching times test circuit for resistive load



Figure 14. Gate charge test circuit

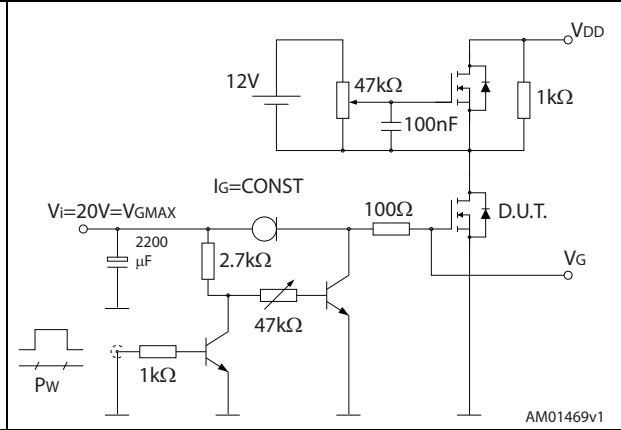

Figure 15. Test circuit for inductive load switching and diode recovery times



Figure 16. Unclamped inductive load test circuit



Figure 17. Unclamped inductive waveform

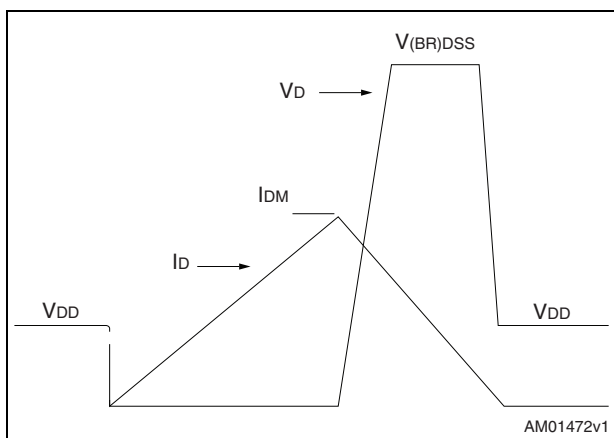

Figure 18. Switching time waveform

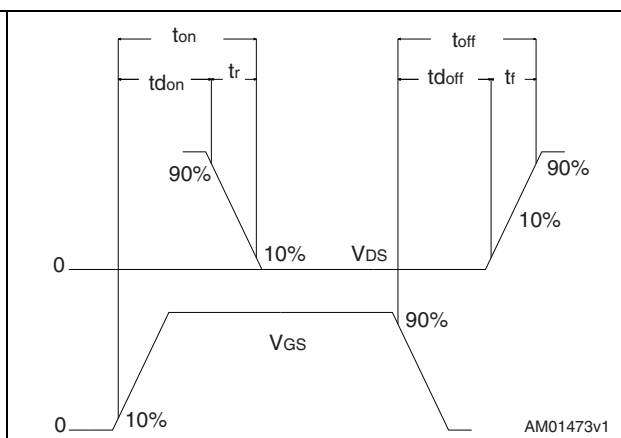
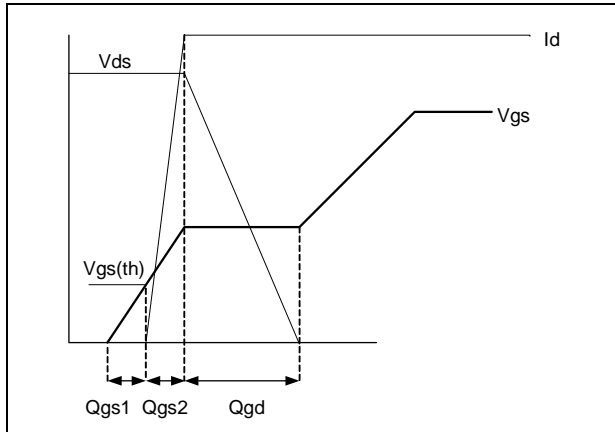



Figure 19. Gate charge waveform



## 4 Package information

In order to meet environmental requirements, ST offers these devices in different grades of ECOPACK<sup>®</sup> packages, depending on their level of environmental compliance. ECOPACK<sup>®</sup> specifications, grade definitions and product status are available at: [www.st.com](http://www.st.com). ECOPACK is an ST trademark.

Figure 20. DPAK (TO-252) type A2 outline

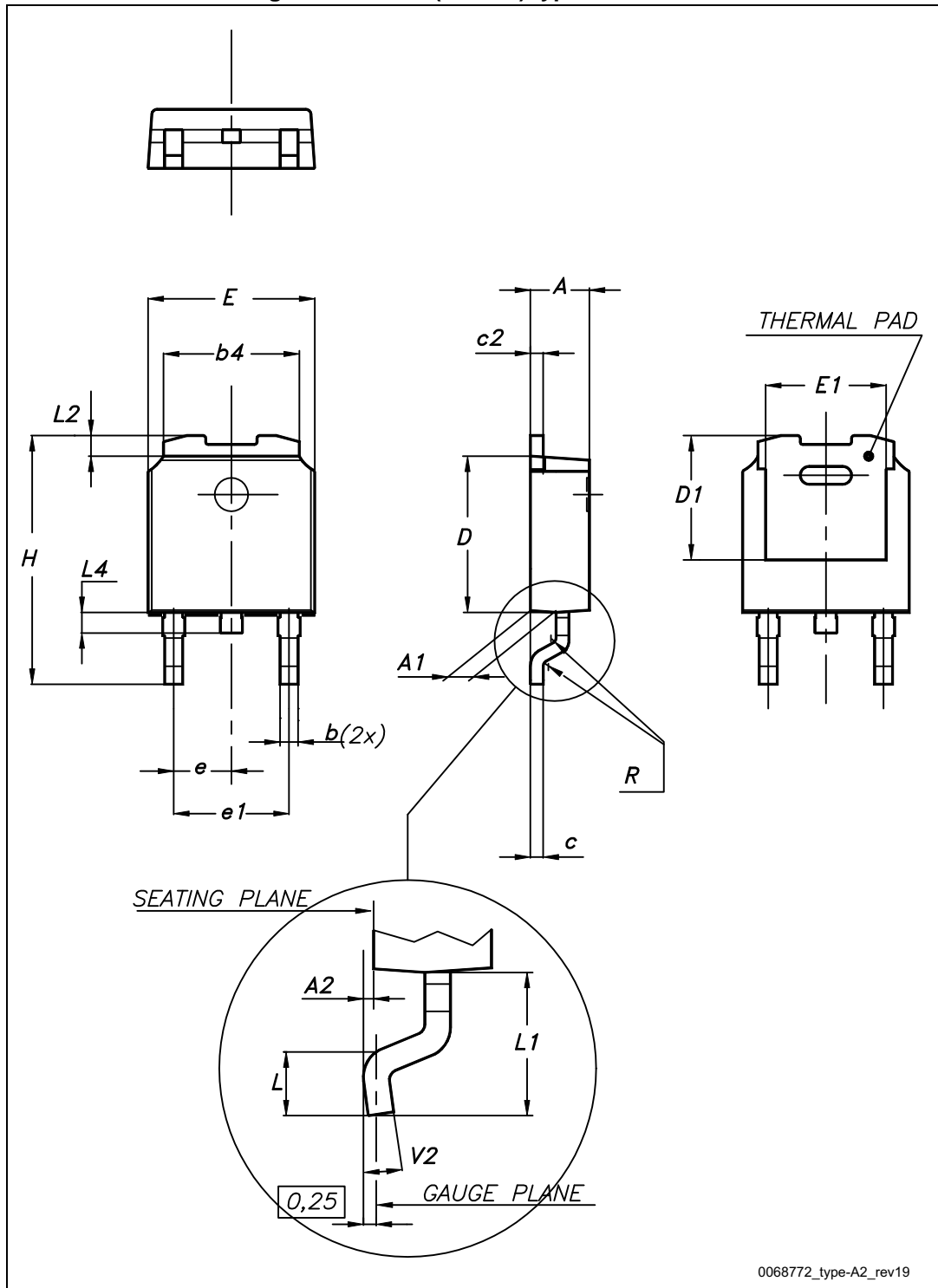
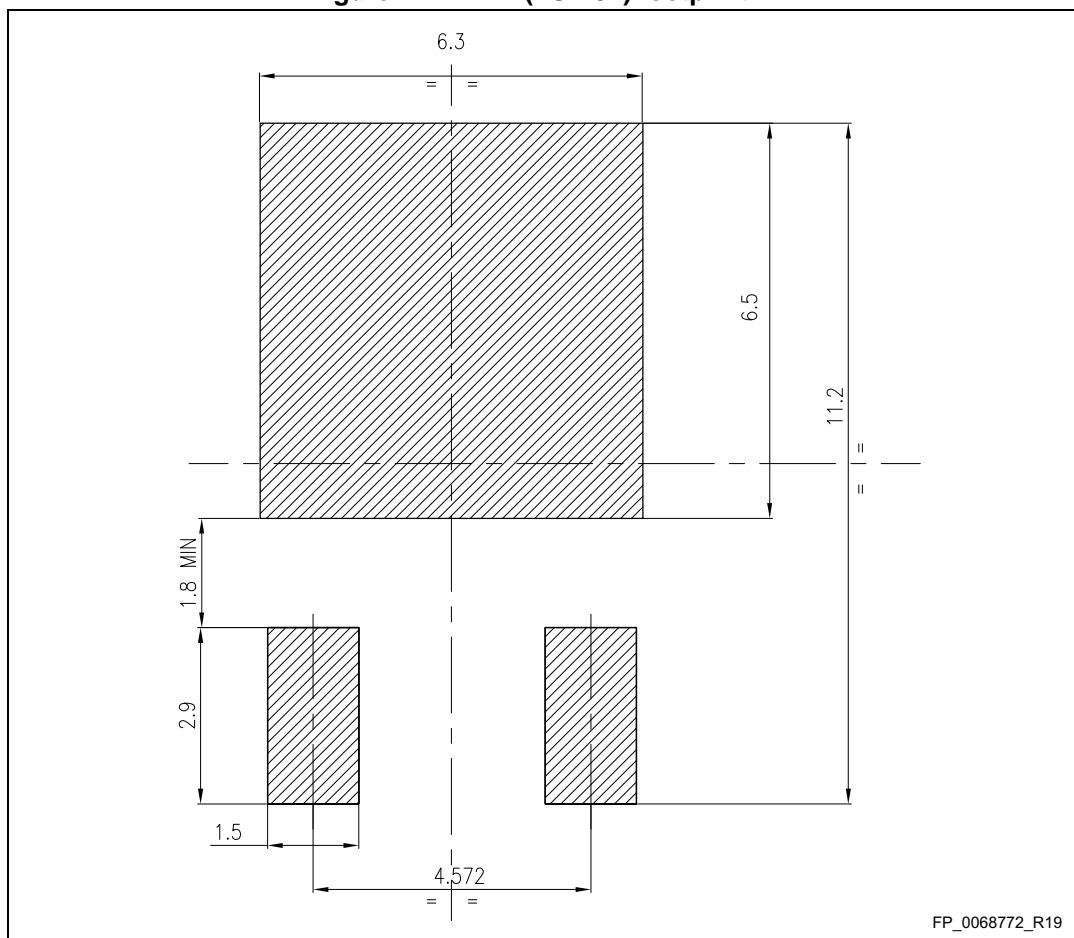

Table 8. DPAK (TO-252) type A2 mechanical data

Dim.	mm		
	Min.	Typ.	Max.
A	2.20		2.40
A1	0.90		1.10
A2	0.03		0.23
b	0.64		0.90
b4	5.20		5.40
c	0.45		0.60
c2	0.48		0.60
D	6.00		6.20
D1	4.95	5.10	5.25
E	6.40		6.60
E1	5.10	5.20	5.30
e	2.16	2.28	2.40
e1	4.40		4.60
H	9.35		10.10
L	1.00		1.50
L1	2.60	2.80	3.00
L2	0.65	0.80	0.95
L4	0.60		1.00
R		0.20	
V2	0°		8°

Figure 21. DPAK (TO-252) footprint (a)



a. All dimensions are in millimeters

# 5 Packing information

Figure 22. Tape for DPAK (TO-252)

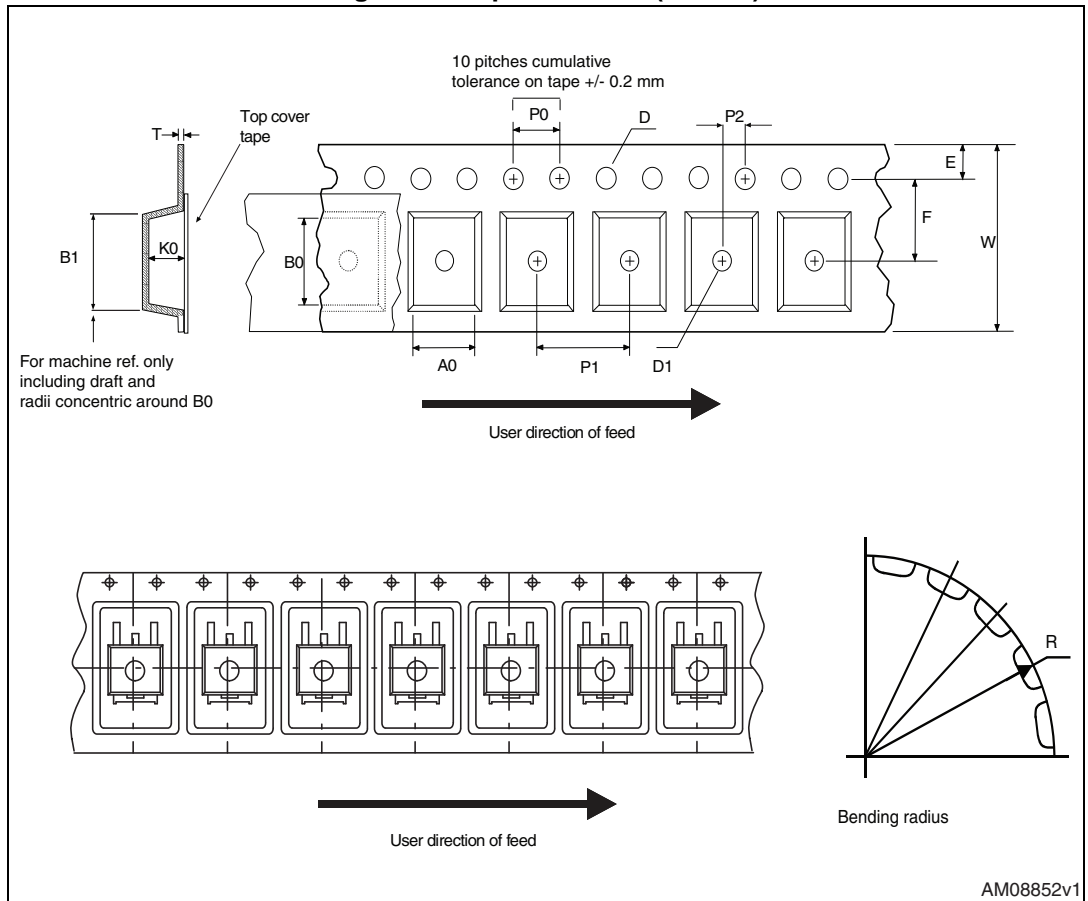
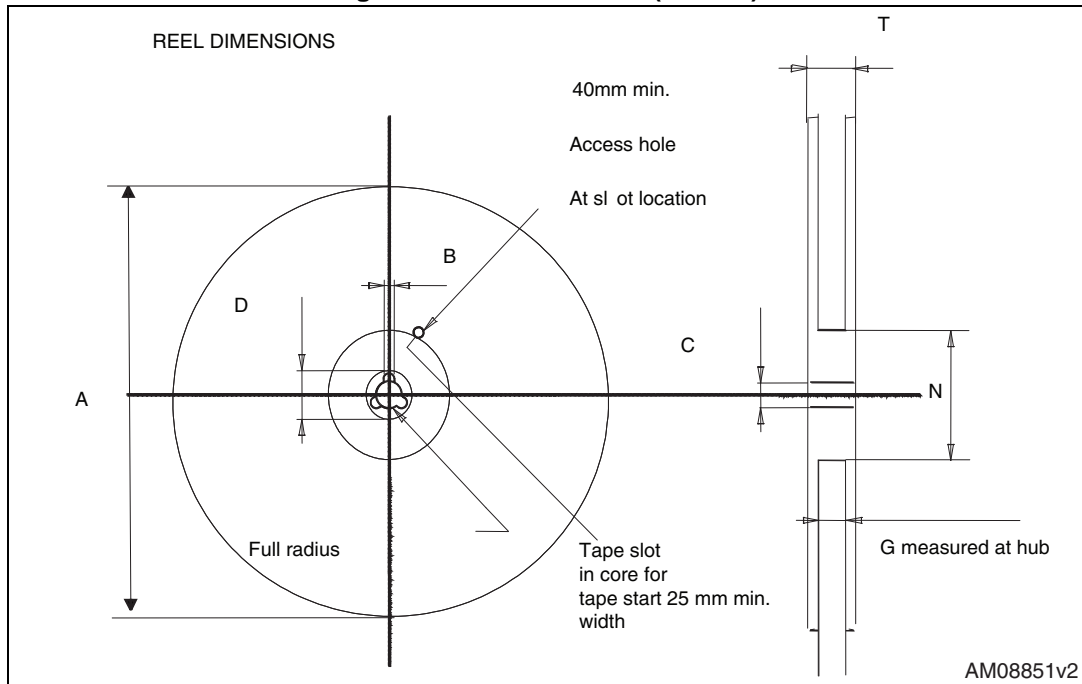

Figure 23. Reel for DPAK (TO-252)



AM08851v2

Table 9. DPAK (TO-252) tape and reel mechanical data

Tape			Reel		
Dim.	mm		Dim.	mm	
	Min.	Max.		Min.	Max.
A0	6.8	7	A		330
B0	10.4	10.6	B	1.5	
B1		12.1	C	12.8	13.2
D	1.5	1.6	D	20.2	
D1	1.5		G	16.4	18.4
E	1.65	1.85	N	50	
F	7.4	7.6	T		22.4
K0	2.55	2.75			
P0	3.9	4.1		Base qty.	2500
P1	7.9	8.1		Bulk qty.	2500
P2	1.9	2.1			
R	40				
T	0.25	0.35			
W	15.7	16.3			

## 6 Revision history

Table 10. Document revision history

Date	Revision	Changes
10-Apr-2009	1	First release.
22-Mar-2011	2	$V_{GS}$ value has been corrected in <a href="#">Table 2</a> and <a href="#">Table 4</a> .
13-May-2015	3	Updated title, features and description in cover page. Updated <a href="#">Section 4: Package information</a> .



**IMPORTANT NOTICE – PLEASE READ CAREFULLY**

STMicroelectronics NV and its subsidiaries ("ST") reserve the right to make changes, corrections, enhancements, modifications, and improvements to ST products and/or to this document at any time without notice. Purchasers should obtain the latest relevant information on ST products before placing orders. ST products are sold pursuant to ST's terms and conditions of sale in place at the time of order acknowledgement.

Purchasers are solely responsible for the choice, selection, and use of ST products and ST assumes no liability for application assistance or the design of Purchasers' products.

No license, express or implied, to any intellectual property right is granted by ST herein.

Resale of ST products with provisions different from the information set forth herein shall void any warranty granted by ST for such product.

ST and the ST logo are trademarks of ST. All other product or service names are the property of their respective owners.

Information in this document supersedes and replaces information previously supplied in any prior versions of this document.

© 2015 STMicroelectronics – All rights reserved



单击下面可查看定价，库存，交付和生命周期等信息

[>>STMicroelectronics\(意法半导体\)](#)