

## General information

**IGBT Stack for typical voltages of up to 400 V<sub>RMS</sub>**  
**Rated output current 900 A<sub>RMS</sub>**

- Solar power
  - Motor drives
  - High power converter
- 
- 62mm power module
  - Trenchstop™ IGBT4

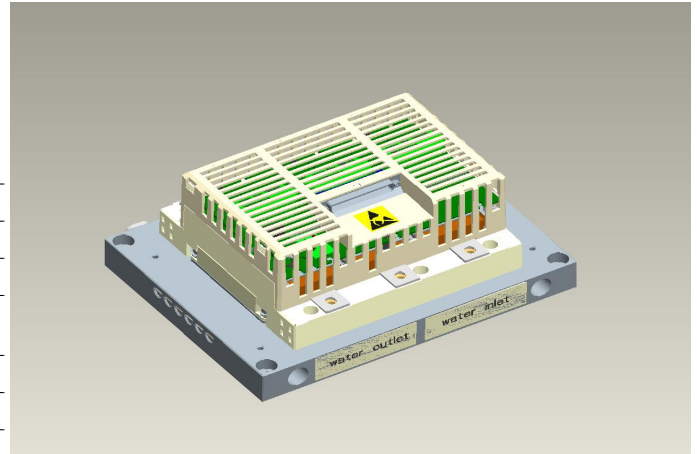

Topology	1/2 B2I
Application	Inverter
Load type	resistive, inductive
Semiconductor (Inverter Section)	3x FF450R12KE4
Heatsink	water cooled
Implemented sensors	current, voltage, temperature
Driver signals IGBT	Electrical
Design standards	EN 50178
Approvals	UL 508C
Sales - name	2PS13512E43W39689
SP - No.	SP001132612

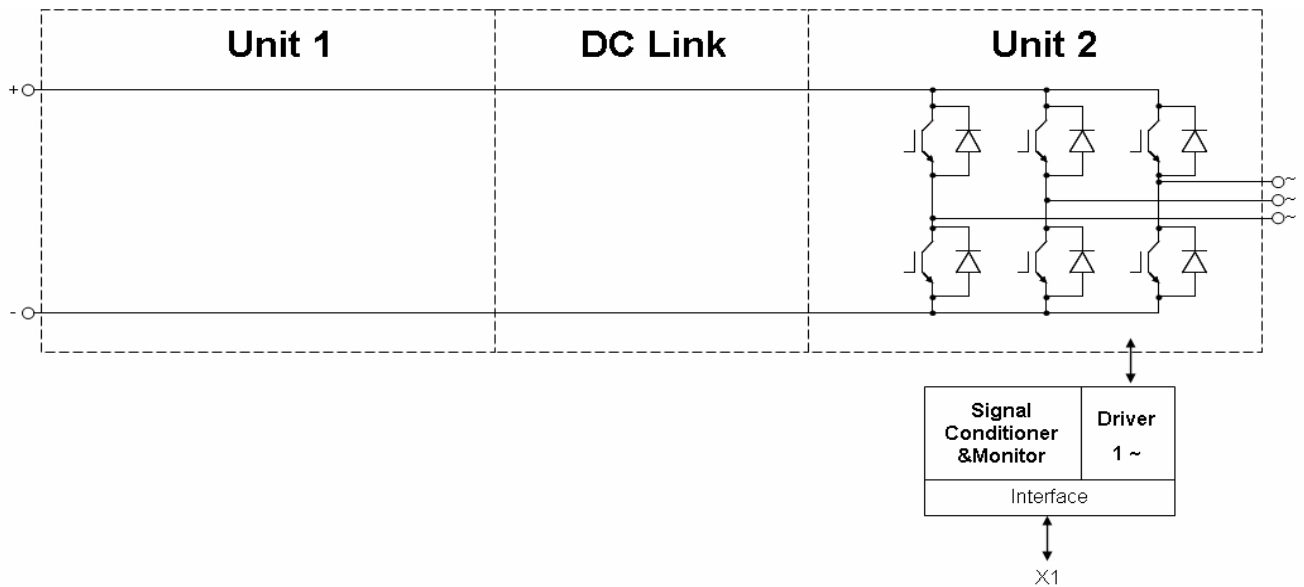

prepared by: OW	date of publication: 2014-07-16
approved by: YZ	revision: 2.0



Preliminary data

**Absolute maximum rated values**

Collector-emitter voltage	IGBT; $T_{vj} = 25^{\circ}\text{C}$	$V_{CES}$	1200	V
Repetitive peak reverse voltage	Diode; $T_{vj} = 25^{\circ}\text{C}$	$V_{RRM}$	1200	V
Insulation management	according to installation height of 2000 m	$V_{line}$	500	$V_{RMS}$
Insulation test voltage	according to EN50178, $f = 50\text{ Hz}$ , $t = 1\text{ s}$	$V_{ISOL}$	2.5	$kV_{RMS}$
Switching frequency inverter section		$f_{sw2}$	8	kHz

**Notes**

Further maximum ratings are specified in the following dedicated sections

**Characteristic values**

**DC Link**

			min.	typ.	max.	
Rated voltage		$V_{DC}$		650	850	V

**Notes**

The over voltage shutdown level is above the max. rated DC voltage. Therefore this function can not be used

**Inverter Section**

			min.	typ.	max.	
Rated continuous current	$V_{DC} = 650\text{ V}$ , $V_{AC} = 400\text{ V}_{RMS}$ , $\cos(\varphi) = 0.85$ , $f_{AC\ sine} = 50\text{ Hz}$ , $f_{sw} = 5000\text{ Hz}$ , $T_{inlet} = 40^{\circ}\text{C}$ , $T_j \leq 125^{\circ}\text{C}$	$I_{AC}$			900	$A_{RMS}$
Continuous current at low frequency	$V_{DC} = 650\text{ V}$ , $\cos(\varphi) = 0.85$ , $f_{AC\ sine} = 0\text{ Hz}$ , $f_{sw} = 5000\text{ Hz}$ , $T_{inlet} = 40^{\circ}\text{C}$ , $T_j \leq 125^{\circ}\text{C}$	$I_{AC\ low}$			540	$A_{RMS}$
Rated continuous current for 150% overload capability	$I_{AC\ 150\%} = 1080\text{ A}_{RMS}$ , $t_{on\ over} = 60\text{ s}$ , $t_{recovery} = 600\text{ s}$ , $T_j \leq 125^{\circ}\text{C}$	$I_{AC\ over1}$			720	$A_{RMS}$
Over current shutdown	within $15\ \mu\text{s}$	$I_{AC\ OC}$			1860	$A_{peak}$
Power losses	$I_{AC} = 900\text{ A}$ , $V_{DC} = 650\text{ V}$ , $V_{AC} = 400\text{ V}_{RMS}$ , $\cos(\varphi) = 0.85$ , $f_{AC\ sine} = 50\text{ Hz}$ , $f_{sw} = 5000\text{ Hz}$ , $T_{inlet} = 40^{\circ}\text{C}$ , $T_j \leq 125^{\circ}\text{C}$	$P_{loss}$			2940	W

**Notes**

Maximum junction temperature limited to  $125^{\circ}\text{C}$  under all operating conditions

**Controller interface**

Driver and interface board	ref. to separate Application Note		DR240			
			min.	typ.	max.	
Auxiliary voltage		$V_{aux}$	18	24	40	V
Auxiliary power requirement	$V_{aux} = 24\text{ V}$	$P_{aux}$			40	W
Digital input level	resistor to GND $10\text{ k}\Omega$ , capacitor to GND $1\text{ nF}$	$V_{in\ low}$	0		4	V
		$V_{in\ high}$	11		15	V
Digital output level	open collector, logic low = no fault, max. $15\text{ mA}$	$V_{out\ low}$	0		1.5	V
		$V_{out\ high}$		15		V
Analog current sensor output inverter section	load max $5\text{ mA}$ , @ $900\text{ A}_{RMS}$	$V_{IU\ ana2}$ $V_{IV\ ana2}$ $V_{IW\ ana2}$	4.8	4.9	5	V
Analog DC link voltage sensor output	load max $5\text{ mA}$ , @ $800\text{ V}$	$V_{DC\ ana}$	5.5	5.7	5.8	V
Analog temperature sensor output inverter section (Simulated)	load max $5\text{ mA}$ , @ $T_{NTC} = 55^{\circ}\text{C}$ , corresponds to $T_j = 125^{\circ}\text{C}$ at rated conditions	$V_{Theta\ sim2}$		4.5		V
Over temperature shutdown inverter section	@ $T_{NTC} = 81^{\circ}\text{C}$	$V_{Error\ OT2}$		10		V

prepared by: OW	date of publication: 2014-07-16
approved by: YZ	revision: 2.0

# Technical Information

PrimeSTACK™

# 2PS13512E43W39689



## Preliminary data

### System data

				min.	typ.	max.	
EMC robustness	according to IEC 61800-3 at named interfaces	power	$V_{Burst}$	2			kV
		control	$V_{Burst}$	1			kV
		aux (24V)	$V_{surge}$	1			kV
Storage temperature		$T_{stor}$	-40		80	°C	
Operational ambient temperature	PCB, DC link capacitor, bus bar, excluding cooling medium	$T_{op\ amb}$	-25		55	°C	
Cooling air velocity	PCB, DC link capacitor, bus bar, standard atmosphere	$V_{air}$	0.3			m/s	
Humidity	no condensation	Rel. F	0		85	%	
Vibration	according to IEC 60721				5	m/s <sup>2</sup>	
Shock	according to IEC 60721				40	m/s <sup>2</sup>	
Protection degree			IP00				
Pollution degree			2				
Dimensions	width x depth x height		260	280	120	mm	
Weight			7.7			kg	

### Heatsink water cooled

				min.	typ.	max.	
Water flow	according to coolant specification from Infineon	$\Delta V/\Delta t$	10				dm <sup>3</sup> /min
Water pressure				30			bar
Water pressure drop		$\Delta p$			8		mbar
Coolant inlet temperature		$T_{inlet}$	-40		70		°C
Cooling channel material			Aluminium				

#### Notes

Conditions are standard Infineon characterization for heatsinks.

### Overview of optional components

	Unit 1	Inverter Section	Unit 3
Parallel interface board			
Optical interface board			
Chopper controller			
Voltage sensor		×	
Current sensor		×	
Temperature sensor		×	
DC link capacitors			

#### Notes

Setting of Active Clamping TVS-Diodes:  $V_z = 824\text{ V}$

prepared by: OW	date of publication: 2014-07-16
approved by: YZ	revision: 2.0



### Preliminary data

fo - derating curve IGBT (motor), Diode (generator)  
 cos(phi) = ± 0,85  
 T<sub>cool medium</sub> = 40°C

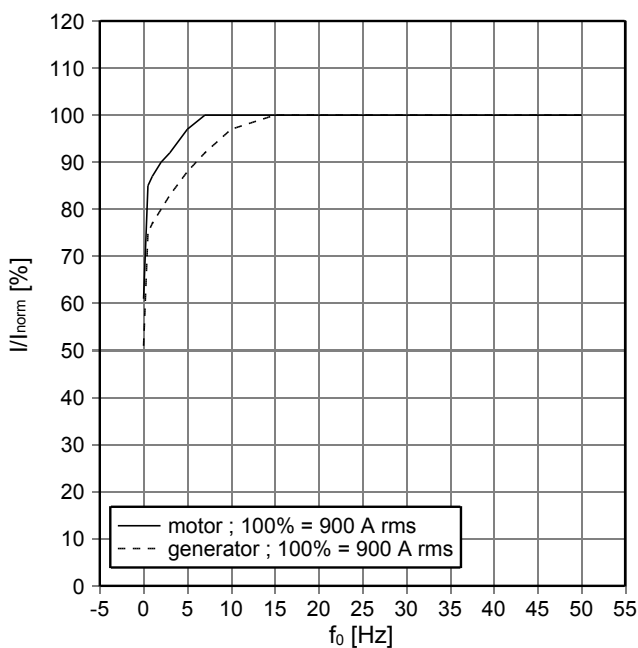

fsw - derating curve IGBT (motor), Diode (generator)  
 cos(phi) = ± 0,85  
 T<sub>cool medium</sub> = 40°C

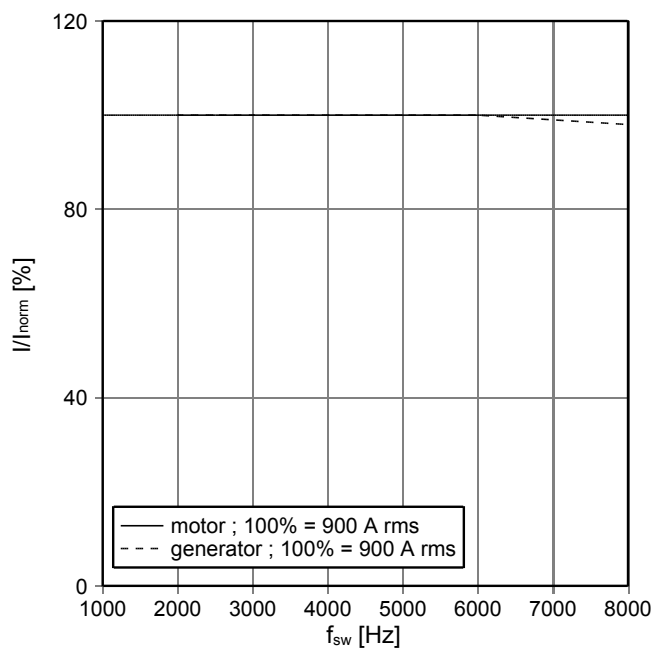

Continuous current derating curves vs. dc link voltage  
 cos(phi) = ± 0,85  
 T<sub>cool medium</sub> = 40°C

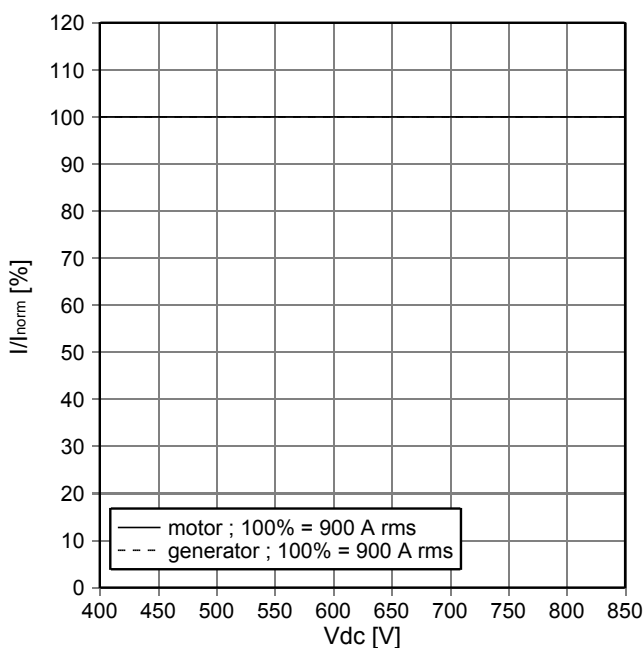

Continuous current derating curves vs. T<sub>cool medium</sub>  
 cos(phi) = ± 0,85

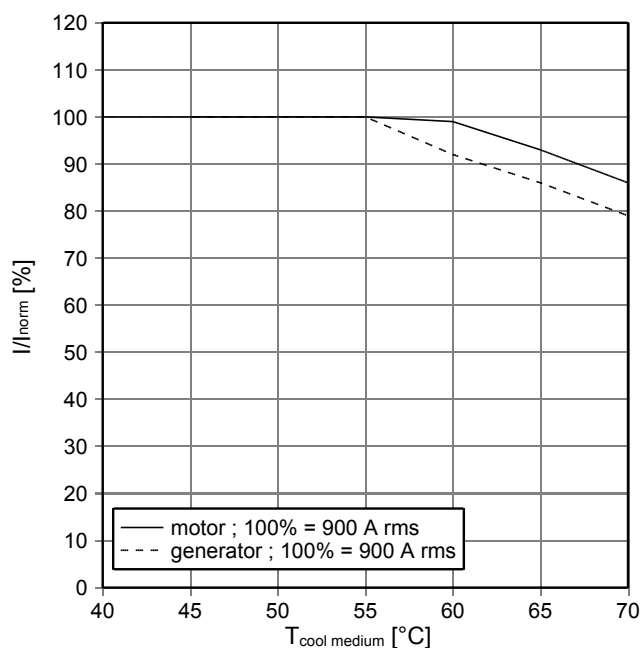

prepared by: OW	date of publication: 2014-07-16
approved by: YZ	revision: 2.0

Zth heat sink to ambient per switch

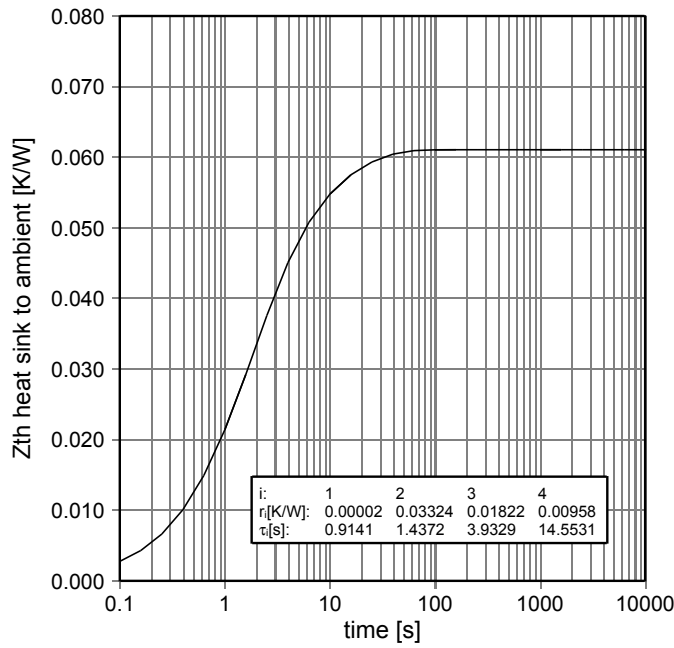

prepared by: OW	date of publication: 2014-07-16
approved by: YZ	revision: 2.0



Circuit diagram

Circuit diagram

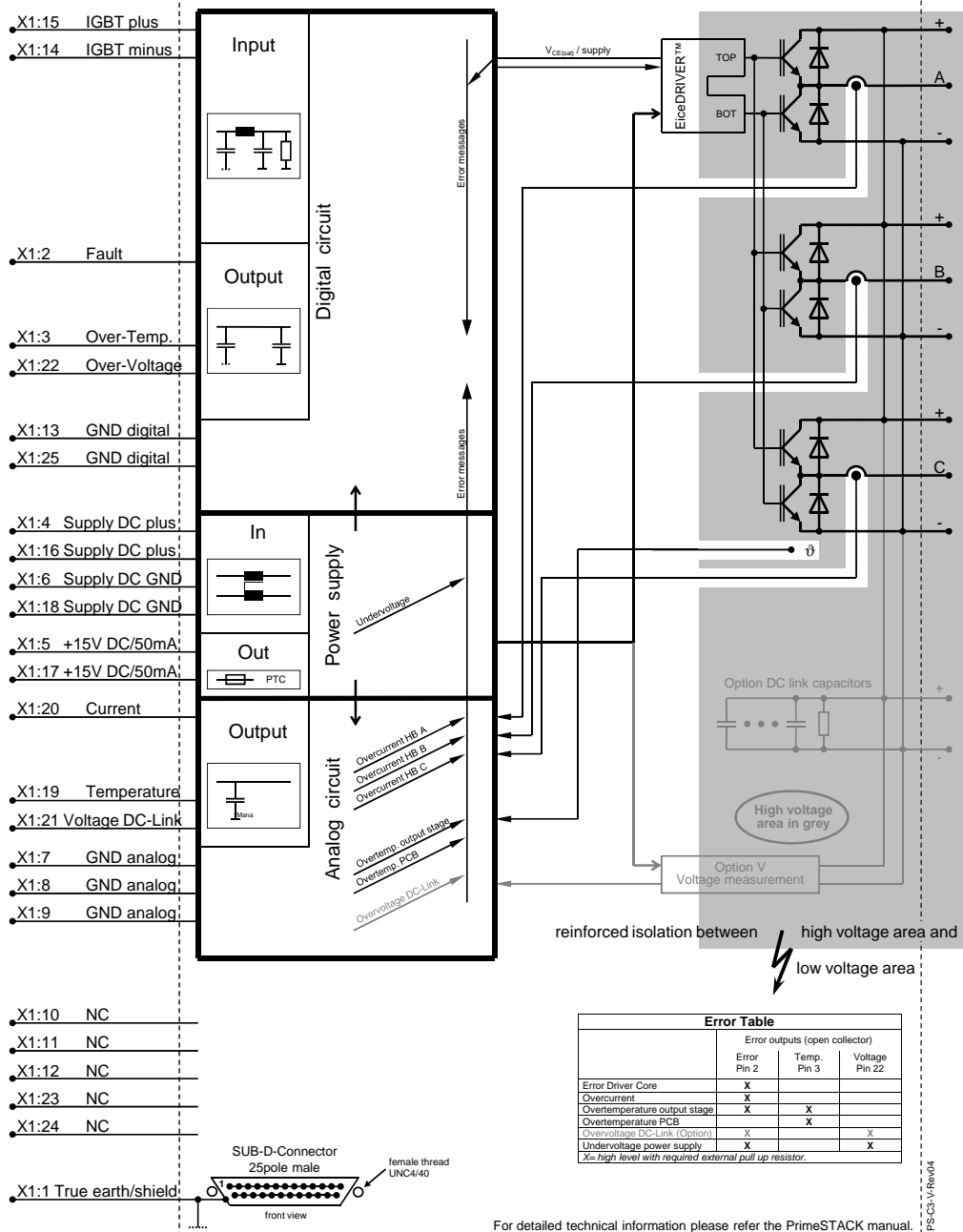

For detailed technical information please refer the PrimeSTACK manual.

prepared by: OW	date of publication: 2014-07-16
approved by: YZ	revision: 2.0



Preliminary data

Terms & Conditions of usage

The data contained in this product data sheet is exclusively intended for technically trained staff. You and your technical departments will have to evaluate the suitability of the product for the intended application and the completeness of the product data with respect to such application.

This product data sheet is describing the characteristics of this product for which a warranty is granted. Any such warranty is granted exclusively pursuant the terms and conditions of the supply agreement. There will be no guarantee of any kind for the product and its characteristics.

Should you require product information in excess of the data given in this product data sheet or which concerns the specific application of our product, please contact the sales office, which is responsible for you (see www.infineon.com, sales&contact). For those that are specifically interested we may provide application notes.

Due to technical requirements our product may contain dangerous substances. For information on the types in question please contact the sales office, which is responsible for you.

Should you intend to use the Product in aviation applications, in health or live endangering or life support applications, please notify. Please note, that for any such applications we urgently recommend

- to perform joint Risk and Quality Assessments;
- the conclusion of Quality Agreements;
- to establish joint measures of an ongoing product survey, and that we may make delivery depended on the realization of any such measures.

If and to the extent necessary, please forward equivalent notices to your customers.

Changes of this product data sheet are reserved.

Safety Instructions

Prior to installation and operation, all safety notices and warnings and all warning signs attached to the equipment have to be carefully read. Make sure that all warning signs remain in a legible condition and that missing or damaged signs are replaced. To installation and operation, all safety notices and warnings and all warning signs attached to the equipment have to be carefully read. Make sure that all warning signs remain in a legible condition and that missing or damaged signs are replaced.

prepared by: OW	date of publication: 2014-07-16
approved by: YZ	revision: 2.0



单击下面可查看定价，库存，交付和生命周期等信息

[>>Infineon Technologies\(英飞凌\)](#)