

MS5611-01BA03

Barometric Pressure Sensor, with stainless steel cap

SPECIFICATIONS

- High resolution module, 10 cm
- Fast conversion down to 1 ms
- Low power, 1 μ A (standby < 0.15 μ A)
- QFN package 5.0 x 3.0 x 1.0 mm³
- Supply voltage 1.8 to 3.6 V
- Integrated digital pressure sensor (24 bit $\Delta\Sigma$ ADC)
- Operating range: 10 to 1200 mbar, -40 to +85 °C
- I²C and SPI interface up to 20 MHz
- No external components (Internal oscillator)
- Excellent long-term stability

The MS5611-01BA is a new generation of high resolution altimeter sensors from MEAS Switzerland with SPI and I²C bus interface. This barometric pressure sensor is optimized for altimeters and variometers with an altitude resolution of 10 cm. The sensor module includes a high linearity pressure sensor and an ultra-low power 24 bit $\Delta\Sigma$ ADC with internal factory calibrated coefficients. It provides a precise digital 24 Bit pressure and temperature value and different operation modes that allow the user to optimize for conversion speed and current consumption. A high resolution temperature output allows the implementation of an altimeter/thermometer function without any additional sensor. The MS5611-01BA can be interfaced to virtually any microcontroller. The communication protocol is simple, without the need of programming internal registers in the device. Small dimensions of only 5.0 mm x 3.0 mm and a height of only 1.0 mm allow for integration in mobile devices. This new sensor module generation is based on leading MEMS technology and latest benefits from MEAS Switzerland proven experience and know-how in high volume manufacturing of altimeter modules, which have been widely used for over a decade. The sensing principle employed leads to very low hysteresis and high stability of both pressure and temperature signal.

MS5611-01BA03

Barometric Pressure Sensor, with stainless steel cap

FEATURES

FIELD OF APPLICATION

- Mobile altimeter / barometer systems
- Bike computers
- Variometers
- Height sensing for medical alarms
- Indoor navigation

TECHNICAL DATA

Sensor Performances ($V_{DD} = 3\text{ V}$)				
Pressure	Min	Typ	Max	Unit
Range	10		1200	mbar
ADC	24			bit
Resolution (1)	0.065 / 0.042 / 0.027 / 0.018 / 0.012			mbar
Accuracy 25°C, 750 mbar	-1.5		+1.5	mbar
Error band, -20°C to +85°C, 450 to 1100 mbar (2)	-2.5		+2.5	mbar
Response time (1)	0.5 / 1.1 / 2.1 / 4.1 / 8.22			ms
Long term stability		±1		mbar/yr
Temperature	Min	Typ	Max	Unit
Range	-40		+85	°C
Resolution		<0.01		°C
Accuracy	-0.8		+0.8	°C

Notes: (1) Oversampling Ratio: 256 / 512 / 1024 / 2048 / 4096
(2) With autozero at one pressure point

FUNCTIONAL BLOCK DIAGRAM

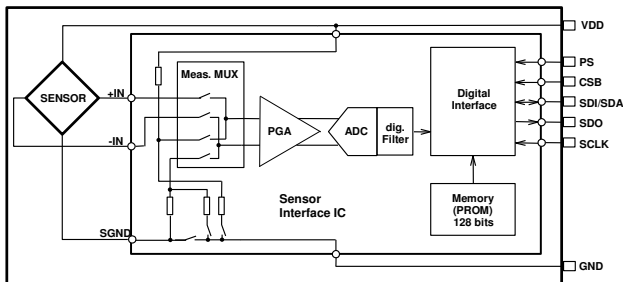

PERFORMANCE SPECIFICATIONS

ABSOLUTE MAXIMUM RATINGS

Parameter	Symbol	Conditions	Min.	Typ.	Max	Unit
Supply voltage	V _{DD}		-0.3		+4.0	V
Storage temperature	T _S		-40		+125	°C
Overpressure	P _{max}				6	bar
Maximum Soldering Temperature	T _{max}	40 sec max			250	°C
ESD rating		Human Body Model	-4		+4	kV
Latch up		JEDEC standard No 78	-100		+100	mA

ELECTRICAL CHARACTERISTICS

Parameter	Symbol	Conditions	Min.	Typ.	Max	Unit
Operating Supply voltage	V _{DD}		1.8	3.0	3.6	V
Operating Temperature	T		-40	+25	+85	°C
Supply current (1 sample per sec.)	I _{DD}	OSR 4096 2048 1024 512 256		12.5 6.3 3.2 1.7 0.9		μA
Peak supply current		during conversion		1.4		mA
Standby supply current		at 25°C		0.02	0.14	μA
VDD Capacitor		From VDD to GND	100			nF

ANALOG DIGITAL CONVERTER (ADC)

Parameter	Symbol	Conditions	Min.	Typ.	Max	Unit
Output Word				24		bit
Conversion time	t _c	OSR 4096 2048 1024 512 256	7.40 3.72 1.88 0.95 0.48	8.22 4.13 2.08 1.06 0.54	9.04 4.54 2.28 1.17 0.60	ms

PERFORMANCE SPECIFICATIONS (CONTINUED)

PRESSURE OUTPUT CHARACTERISTICS ($V_{DD} = 3\text{ V}$, $T = 25^\circ\text{C}$ UNLESS OTHERWISE NOTED)

Parameter	Conditions		Min.	Typ.	Max	Unit
Operating Pressure Range	P_{range}	Full Accuracy	450		1100	mbar
Extended Pressure Range	P_{ext}	Linear Range of ADC	10		1200	mbar
Total Error Band, no autozero	at 25°C , 700..1100 mbar		-1.5		+1.5	mbar
	at $0..50^\circ\text{C}$, 450..1100 mbar		-2.0		+2.0	
	at $-20..85^\circ\text{C}$, 450..1100 mbar		-3.5		+3.5	
	at $-40..85^\circ\text{C}$, 450..1100 mbar		-6.0		+6.0	
Total Error Band, autozero at one pressure point	at 25°C , 700..1100 mbar		-0.5		+0.5	mbar
	at $10..50^\circ\text{C}$, 450..1100 mbar		-1.0		+1.0	
	at $-20..85^\circ\text{C}$, 450..1100 mbar		-2.5		+2.5	
	at $-40..85^\circ\text{C}$, 450..1100 mbar		-5.0		+5.0	
Maximum error with supply voltage	$V_{DD} = 1.8\text{ V} \dots 3.6\text{ V}$			± 2.5		mbar
Long-term stability				± 1		mbar/yr
Recovering time after reflow (1)				7		days
Resolution RMS	OSR	4096		0.012		mbar
		2048		0.018		
		1024		0.027		
		512		0.042		
		256		0.065		

(1) Time to recovering at least 66% of the reflow impact

TEMPERATURE OUTPUT CHARACTERISTICS ($V_{DD} = 3\text{ V}$, $T = 25^\circ\text{C}$ UNLESS OTHERWISE NOTED)

Parameter	Conditions		Min.	Typ.	Max	Unit
Absolute Accuracy	at 25°C		-0.8		+0.8	$^\circ\text{C}$
	$-20..85^\circ\text{C}$		-2.0		+2.0	
	$-40..85^\circ\text{C}$		-4.0		+4.0	
Maximum error with supply voltage	$V_{DD} = 1.8\text{ V} \dots 3.6\text{ V}$			± 0.5		$^\circ\text{C}$
Resolution RMS	OSR	4096		0.002		$^\circ\text{C}$
		2048		0.003		
		1024		0.005		
		512		0.008		
		256		0.012		

PERFORMANCE SPECIFICATIONS (CONTINUED)**DIGITAL INPUTS (CSB, I²C, DIN, SCLK)**

Parameter	Symbol	Conditions	Min.	Typ.	Max	Unit
Serial data clock	SCLK	SPI protocol			20	MHz
Input high voltage	V _{IH}	Pins CSB	80% V _{DD}		100% V _{DD}	V
Input low voltage	V _{IL}		0% V _{DD}		20% V _{DD}	V
Input leakage current	I _{leak25°C} I _{leak85°C}	at 25°C			0.15	μA

PRESSURE OUTPUTS (I²C, DOUT)

Parameter	Symbol	Conditions	Min.	Typ.	Max	Unit
Output high voltage	V _{OH}	I _{source} = 1.0 mA	80% V _{DD}		100% V _{DD}	V
Output low voltage	V _{OL}	I _{sink} = 1.0 mA	0% V _{DD}		20% V _{DD}	V
Load capacitance	C _{LOAD}				16	pF

FUNCTIONAL DESCRIPTION

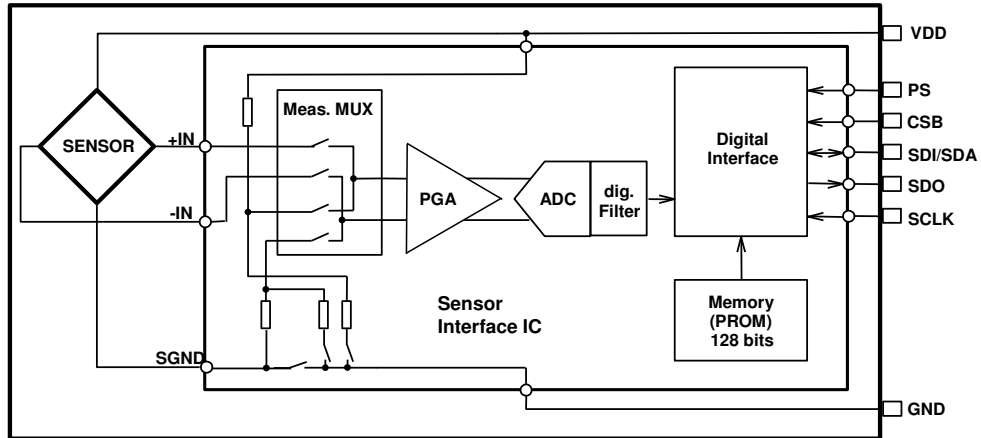

Figure 1: Block diagram of MS5611-01BA

GENERAL

The MS5611-01BA consists of a piezo-resistive sensor and a sensor interface IC. The main function of the MS5611-01BA is to convert the uncompensated analogue output voltage from the piezo-resistive pressure sensor to a 24-bit digital value, as well as providing a 24-bit digital value for the temperature of the sensor.

FACTORY CALIBRATION

Every module is individually factory calibrated at two temperatures and two pressures. As a result, 6 coefficients necessary to compensate for process variations and temperature variations are calculated and stored in the 128-bit PROM of each module. These bits (partitioned into 6 coefficients) must be read by the microcontroller software and used in the program converting D1 and D2 into compensated pressure and temperature values.

SERIAL INTERFACE

The MS5611-01BA has built in two types of serial interfaces: SPI and I²C. Pulling the Protocol Select pin PS to low selects the SPI protocol, pulling PS to high activates the I²C bus protocol.

Pin PS	Mode	Pins used
High	I ² C	SDA
Low	SPI	SDI, SDO, CSB

SPI MODE

The external microcontroller clocks in the data through the input SCLK (Serial CLock) and SDI (Serial Data In). In the SPI mode module can accept both mode 0 and mode 3 for the clock polarity and phase. The sensor responds on the output SDO (Serial Data Out). The pin CSB (Chip Select) is used to enable/disable the interface, so that other devices can talk on the same SPI bus. The CSB pin can be pulled high after the command is sent or after the end of the command execution (for example end of conversion). The best noise performance from the module is obtained when the SPI bus is idle and without communication to other devices during the ADC conversion.

I²C MODE

The external microcontroller clocks in the data through the input SCLK (Serial CLock) and SDA (Serial DAta). The sensor responds on the same pin SDA which is bidirectional for the I²C bus interface. So this interface type uses only 2 signal lines and does not require a chip select, which can be favorable to reduce board space. In I²C-Mode the complement of the pin CSB (Chip Select) represents the LSB of the I²C address. It is possible to use two sensors with two different addresses on the I²C bus. The pin CSB shall be connected to VDD or GND (do not leave unconnected!).

COMMANDS

The MS5611-01BA has only five basic commands:

1. Reset
2. Read PROM (128 bit of calibration words)
3. D1 conversion
4. D2 conversion
5. Read ADC result (24 bit pressure / temperature)

PRESSURE AND TEMPERATURE CALCULATION

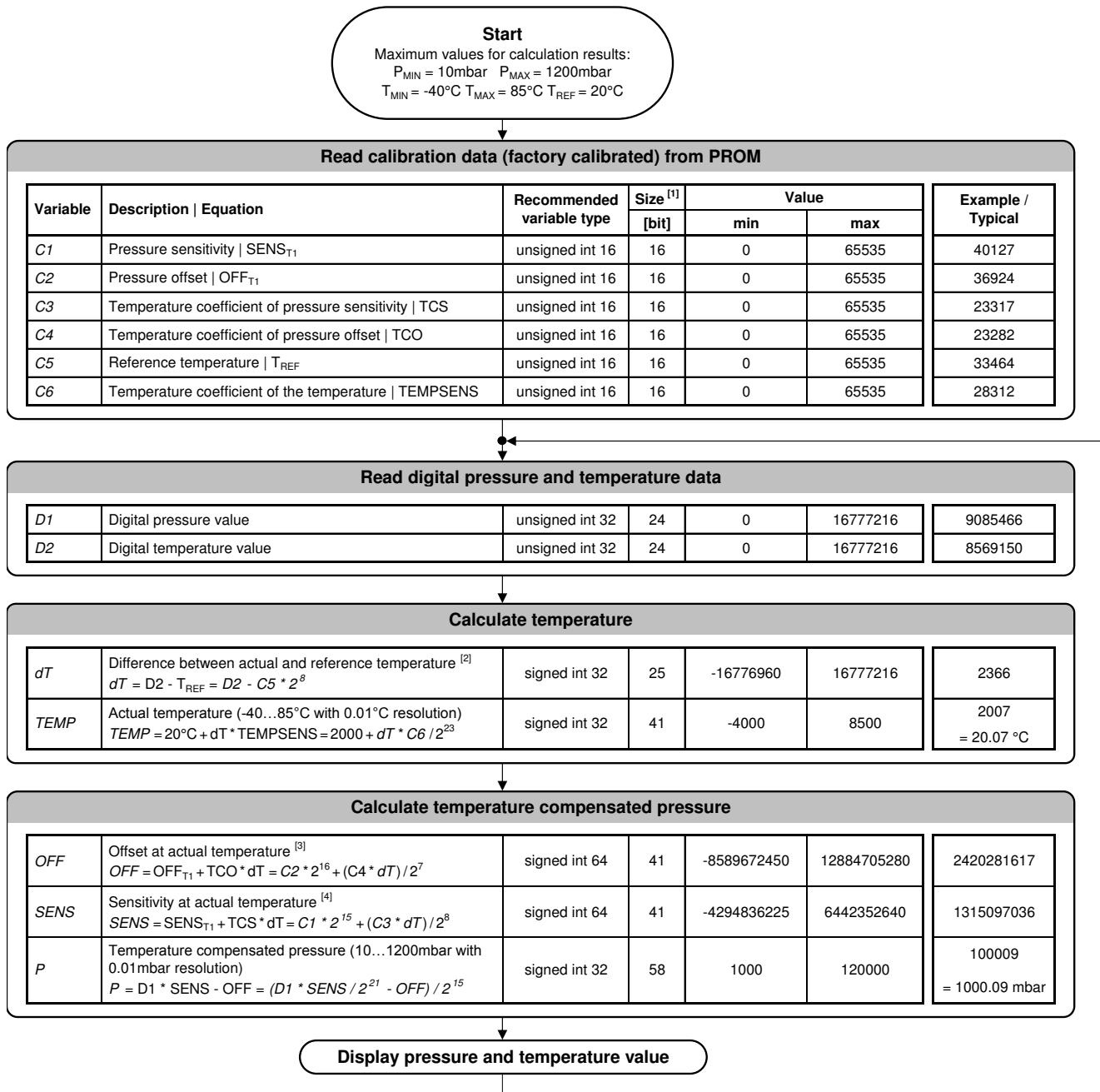

Notes
 [1] Maximal size of intermediate result during evaluation of variable
 [2] min and max have to be defined
 [3] min and max have to be defined
 [4] min and max have to be defined

Figure 2: Flow chart for pressure and temperature reading and software compensation.

SECOND ORDER TEMPERATURE COMPENSATION

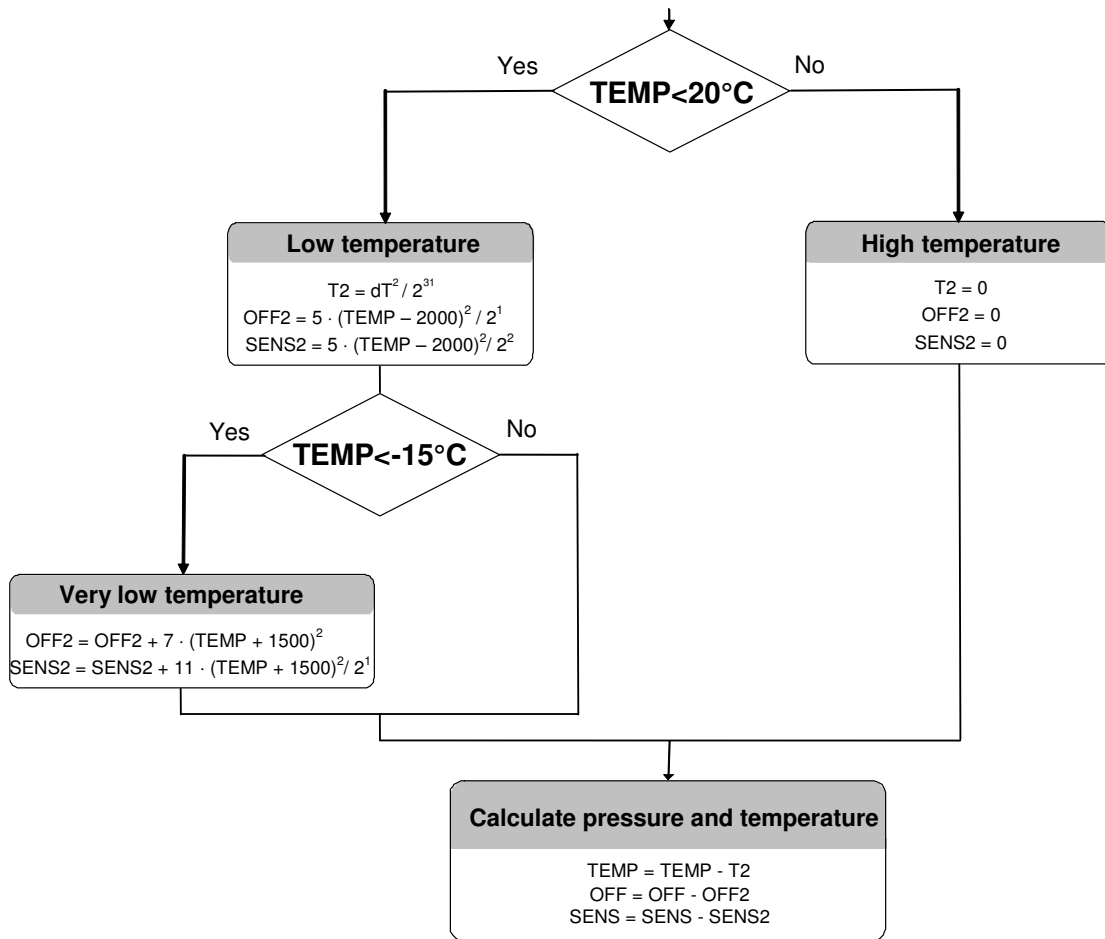

Figure 3: Flow chart for pressure and temperature to the optimum accuracy.

SPI INTERFACE

COMMANDS

Size of each command is 1 byte (8 bits) as described in the table below. After ADC read commands the device will return 24 bit result and after the PROM read 16bit result. The address of the PROM is embedded inside of the PROM read command using the a2, a1 and a0 bits.

Bit number	Command byte								hex value
	0	1	2	3	4	5	6	7	
Bit name	PR M	COV	-	Typ	Ad2/ Os2	Ad1/ Os1	Ad0/ Os0	Stop	
Command									
Reset	0	0	0	1	1	1	1	0	0x1E
Convert D1 (OSR=256)	0	1	0	0	0	0	0	0	0x40
Convert D1 (OSR=512)	0	1	0	0	0	0	1	0	0x42
Convert D1 (OSR=1024)	0	1	0	0	0	1	0	0	0x44
Convert D1 (OSR=2048)	0	1	0	0	0	1	1	0	0x46
Convert D1 (OSR=4096)	0	1	0	0	1	0	0	0	0x48
Convert D2 (OSR=256)	0	1	0	1	0	0	0	0	0x50
Convert D2 (OSR=512)	0	1	0	1	0	0	1	0	0x52
Convert D2 (OSR=1024)	0	1	0	1	0	1	0	0	0x54
Convert D2 (OSR=2048)	0	1	0	1	0	1	1	0	0x56
Convert D2 (OSR=4096)	0	1	0	1	1	0	0	0	0x58
ADC Read	0	0	0	0	0	0	0	0	0x00
PROM Read	1	0	1	0	Ad2	Ad1	Ad0	0	0xA0 to 0xAE

Figure 4: Command structure

RESET SEQUENCE

The Reset sequence shall be sent once after power-on to make sure that the calibration PROM gets loaded into the internal register. It can be also used to reset the device ROM from an unknown condition

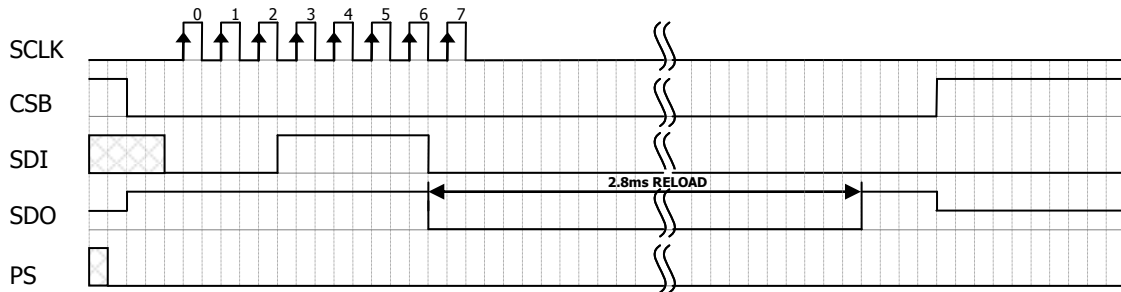

Figure 5: Reset command sequence SPI mode 0

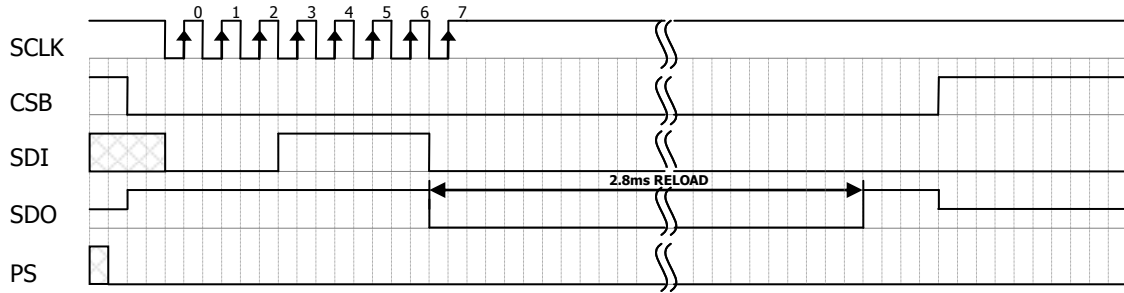

Figure 6: Reset command sequence SPI mode 3

CONVERSION SEQUENCE

The conversion command is used to initiate uncompensated pressure (D1) or uncompensated temperature (D2) conversion. The chip select can be disabled during this time to communicate with other devices.

After the conversion, using ADC read command the result is clocked out with the MSB first. If the conversion is not executed before the ADC read command, or the ADC read command is repeated, it will give 0 as the output result. If the ADC read command is sent during conversion the result will be 0, the conversion will not stop and the final result will be wrong. Conversion sequence sent during the already started conversion process will yield incorrect result as well.

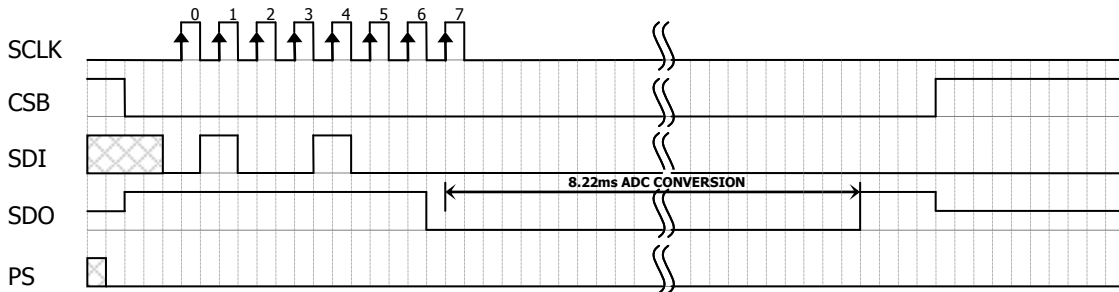

Figure 7: Conversion out sequence, Typ=d1, OSR = 4096

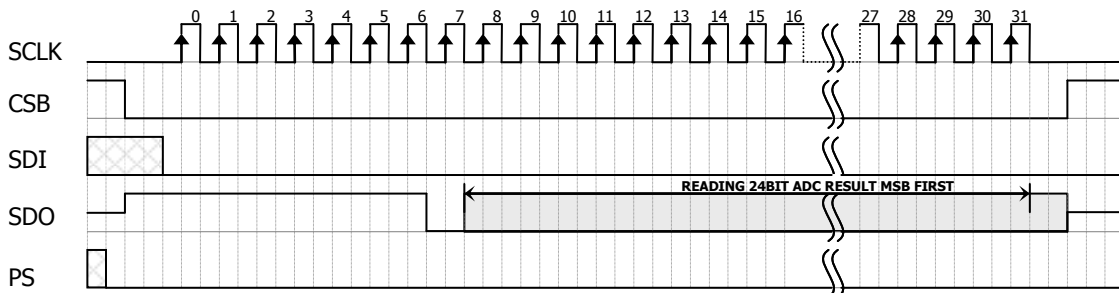

Figure 8: ADC Read sequence

PROM READ SEQUENCE

The read command for PROM shall be executed once after reset by the user to read the content of the calibration PROM and to calculate the calibration coefficients. There are in total 8 addresses resulting in a total memory of 128 bit. Address 0 contains factory data and the setup, addresses 1-6 calibration coefficients and address 7 contains the serial code and CRC. The command sequence is 8 bits long with a 16 bit result which is clocked with the MSB first.

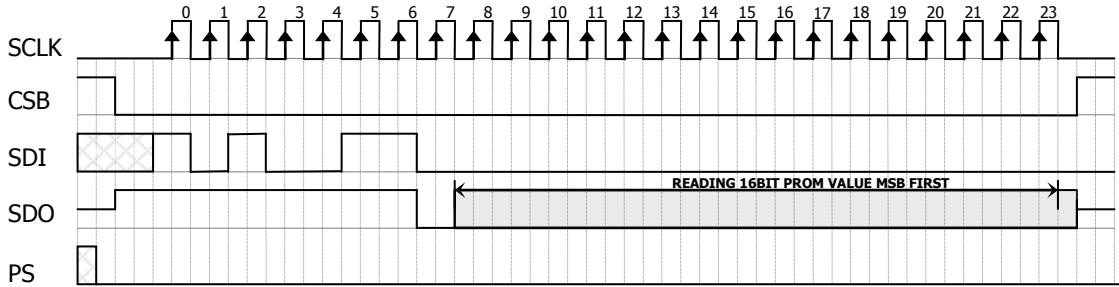

Figure 9: PROM Read sequence, address = 011 (Coefficient 3).

I²C INTERFACE

COMMANDS

Each I²C communication message starts with the start condition and it is ended with the stop condition. The MS5611-01BA address is 111011Cx, where C is the complementary value of the pin CSB. Since the IC does not have a microcontroller inside, the commands for I²C and SPI are quite similar.

RESET SEQUENCE

The reset can be sent at any time. In the event that there is not a successful power on reset this may be caused by the SDA being blocked by the module in the acknowledge state. The only way to get the MS5611-01BA to function is to send several SCLKs followed by a reset sequence or to repeat power on reset.

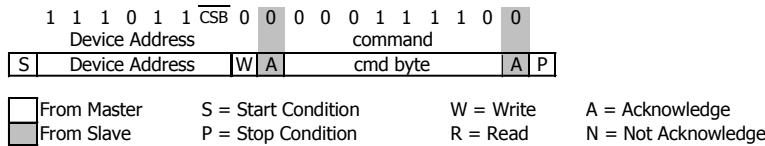

Figure 10: I²C Reset Command

PROM READ SEQUENCE

The PROM Read command consists of two parts. First command sets up the system into PROM read mode. The second part gets the data from the system.

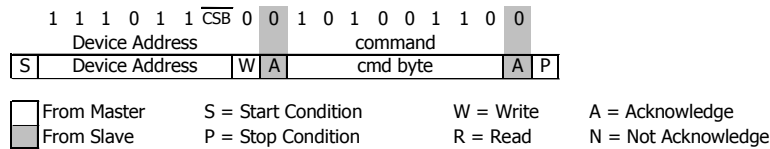

Figure 11: I²C Command to read memory address= 011 (Coefficient 3)

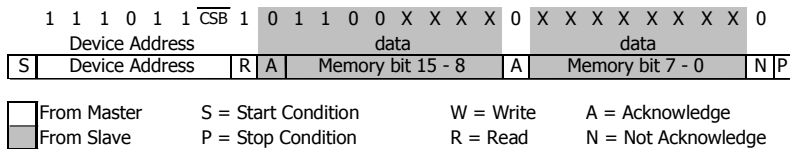

Figure 12: I²C answer from MS5611-01BA

CONVERSION SEQUENCE

A conversion can be started by sending the command to MS5611-01BA. When command is sent to the system it stays busy until conversion is done. When conversion is finished the data can be accessed by sending a Read command, when an acknowledge appears from the MS5611-01BA, 24 SCLK cycles may be sent to receive all result bits. Every 8 bit the system waits for an acknowledge signal.

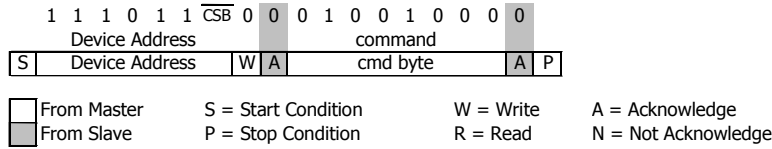

Figure 13: I²C Command to initiate a pressure conversion (OSR=4096, typ=D1)

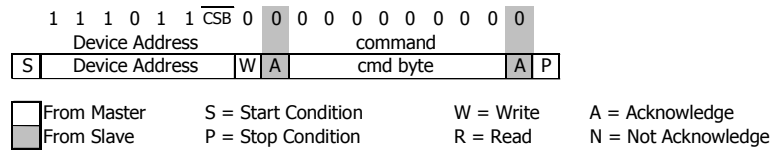

Figure 14: I²C ADC read sequence

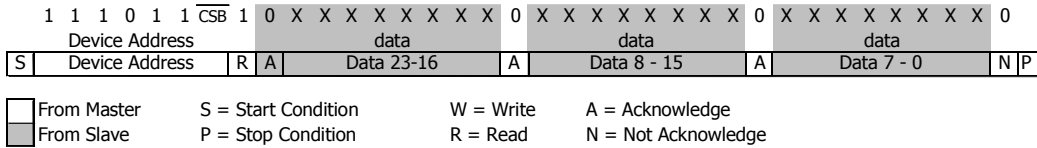

Figure 15: I²C answer from MS5611-01BA

CYCLIC REDUNDANCY CHECK (CRC)

MS5611-01BA contains a PROM memory with 128-Bit. A 4-bit CRC has been implemented to check the data validity in memory. The application note AN520 describes in detail CRC-4 code used.

A	D	D	D	D	D	D	D	D	D	D	D	D	D	D	D	D
d	B	B	B	B	B	B	B	B	B	B	B	B	B	B	B	B
d	1	1	1	1	1	1	9	8	7	6	5	4	3	2	1	0
d	5	4	3	2	1	0										
0	16 bit reserved for manufacturer															
1	Coefficient 1 (16 bit unsigned)															
2	Coefficient 2 (16 bit unsigned)															
3	Coefficient 3 (16 bit unsigned)															
4	Coefficient 4 (16 bit unsigned)															
5	Coefficient 5 (16 bit unsigned)															
6	Coefficient 6 (16 bit unsigned)															
7																CRC

Figure 16: Memory PROM mapping

MS5611-01BA03

Barometric Pressure Sensor, with stainless steel cap

APPLICATION CIRCUIT

The MS5611-01BA is a circuit that can be used in conjunction with a microcontroller in mobile altimeter applications. It is designed for low-voltage systems with a supply voltage of 3 V.

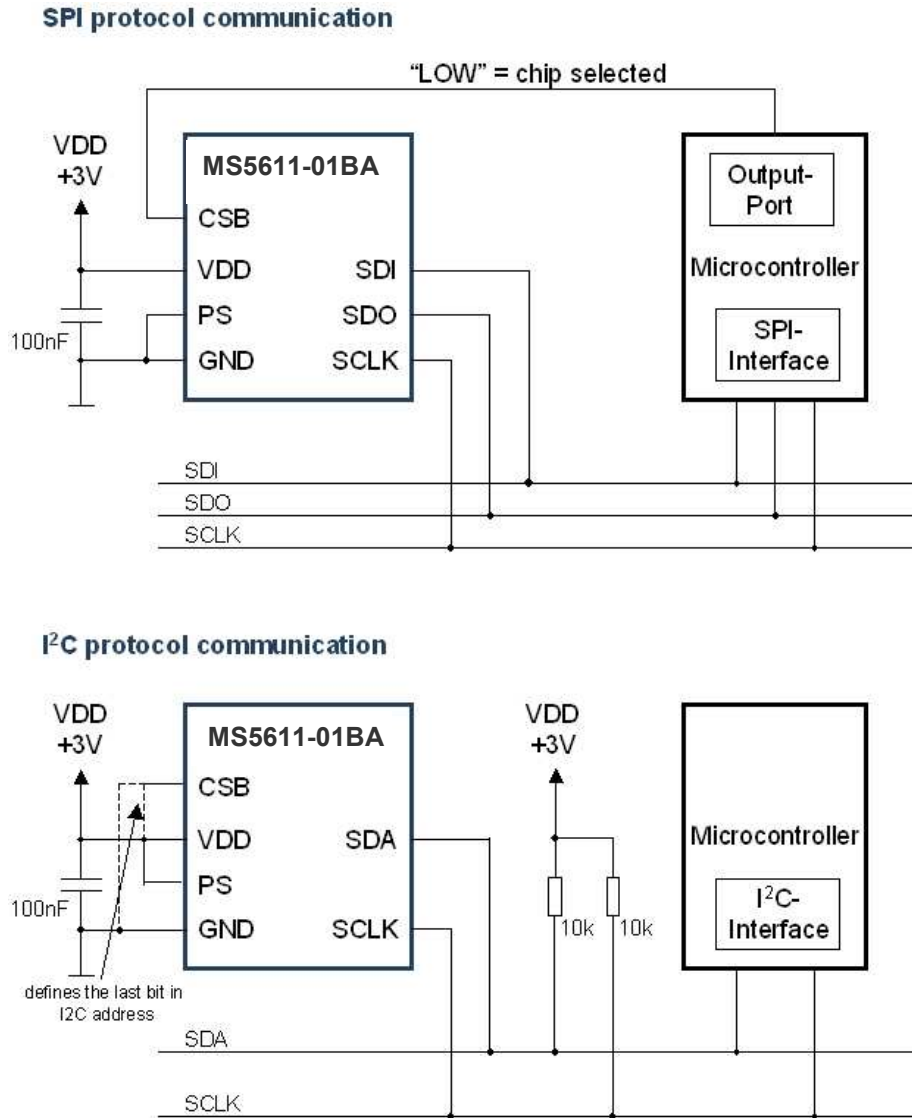

Figure 17: Typical application circuit with SPI / I²C protocol communication

MS5611-01BA03

Barometric Pressure Sensor, with stainless steel cap

PIN CONFIGURATION

Pin	Name	Type	Function
1	VDD	P	Positive supply voltage
2	PS	I	Protocol select PS high (VDD) → I ² C PS low (GND) → SPI
3	GND	G	Ground
4	CSB	I	Chip select (active low), internal connection
5			
6	SDO	O	Serial data output
7	SDI / SDA	I / IO	Serial data input / I ² C data IO
8	SCLK	I	Serial data clock

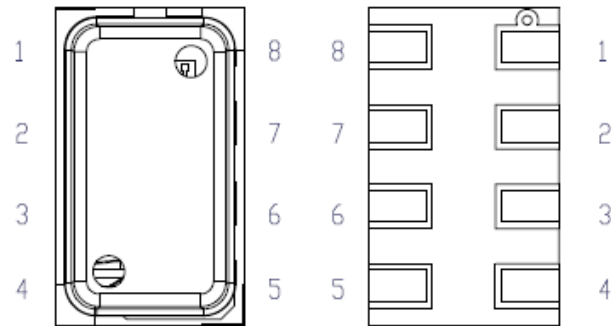

DEVICE PACKAGE OUTLINE

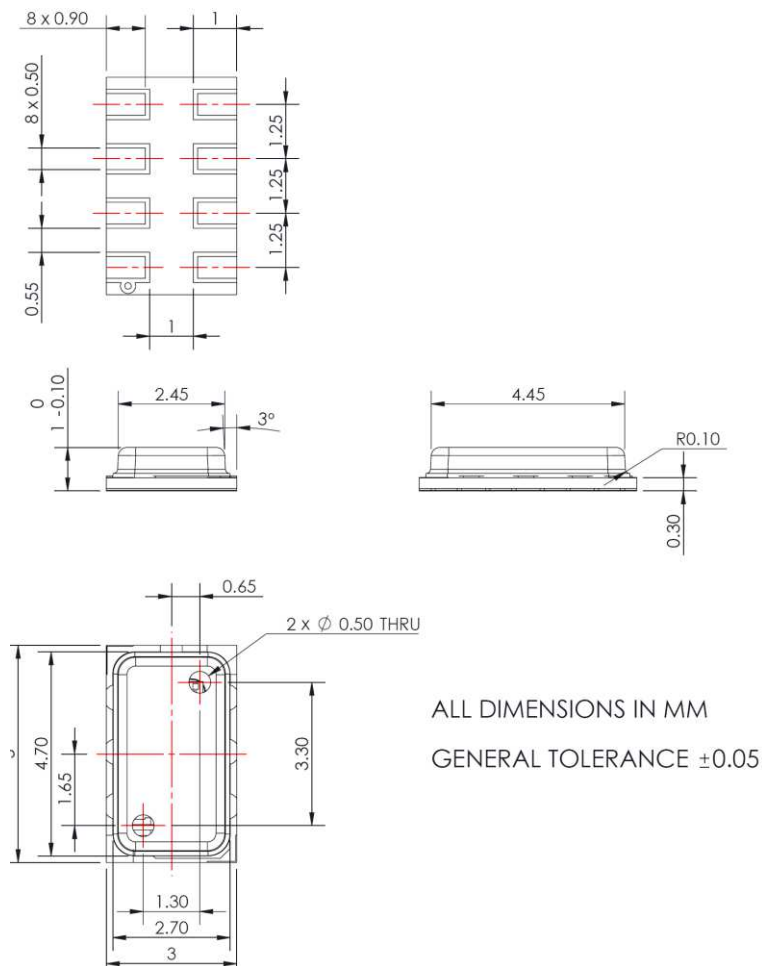

Figure 18: MS5611-01BA03 package outline

MS5611-01BA03

Barometric Pressure Sensor, with stainless steel cap

RECOMMENDED PAD LAYOUT

Pad layout for bottom side of the MS5611-01BA soldered onto printed circuit board.

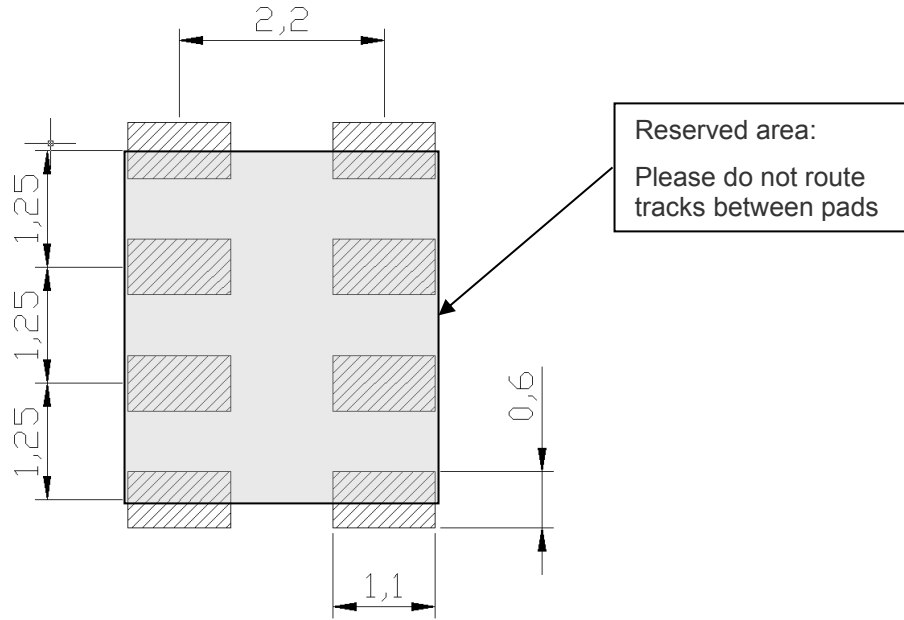

SHIPPING PACKAGE

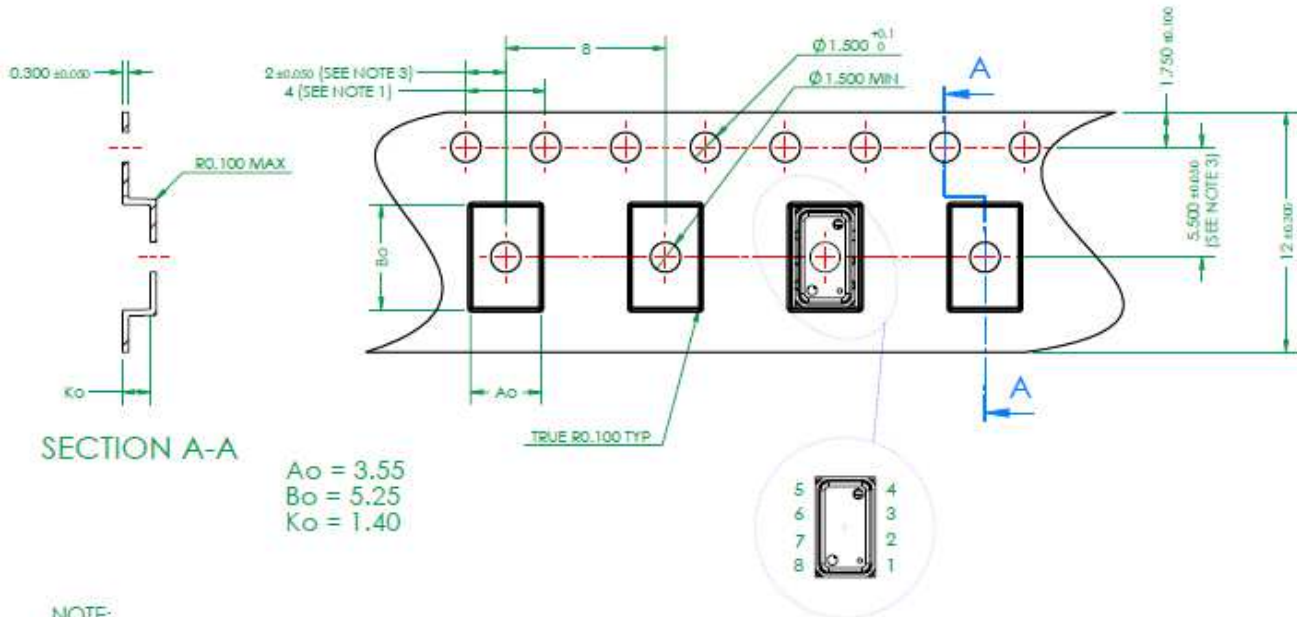

NOTE:

- 1: 10 SPROCKET HOLE PITCH CUMULATIVE TOLERANCE ± 0.2
- 2: CAMBER IN COMPLIANCE WITH EIA 481
- 3: POCKET POSITION RELATIVE TO SPROCKET HOLE MEASURED AS TRUE POSITION OF POCKET, NOT POCKET HOLE

MOUNTING AND ASSEMBLY CONSIDERATIONS

SOLDERING

Please refer to the application note AN808 available on our website for all soldering issues.

MOUNTING

The MS5611-01BA can be placed with automatic Pick & Place equipment using vacuum nozzles. It will not be damaged by the vacuum. Due to the low stress assembly the sensor does not show pressure hysteresis effects. It is important to solder all contact pads.

CONNECTION TO PCB

The package outline of the module allows the use of a flexible PCB for interconnection. This can be important for applications in watches and other special devices.

CLEANING

The MS5611-01BA has been manufactured under cleanroom conditions. It is therefore recommended to assemble the sensor under class 10'000 or better conditions. Should this not be possible, it is recommended to protect the sensor opening during assembly from entering particles and dust. To avoid cleaning of the PCB, solder paste of type "no-clean" shall be used. Cleaning might damage the sensor!

ESD PRECAUTIONS

The electrical contact pads are protected against ESD up to 4 kV HBM (human body model). It is therefore essential to ground machines and personnel properly during assembly and handling of the device. The MS5611-01BA is shipped in antistatic transport boxes. Any test adapters or production transport boxes used during the assembly of the sensor shall be of an equivalent antistatic material.

DECOUPLING CAPACITOR

Particular care must be taken when connecting the device to the power supply. A 100 nF ceramic capacitor must be placed as close as possible to the MS5611-01BA VDD pin. This capacitor will stabilize the power supply during data conversion and thus, provide the highest possible accuracy.

TYPICAL PERFORMANCE CHARACTERISTICS

ADC-value D1 vs Pressure (typical)

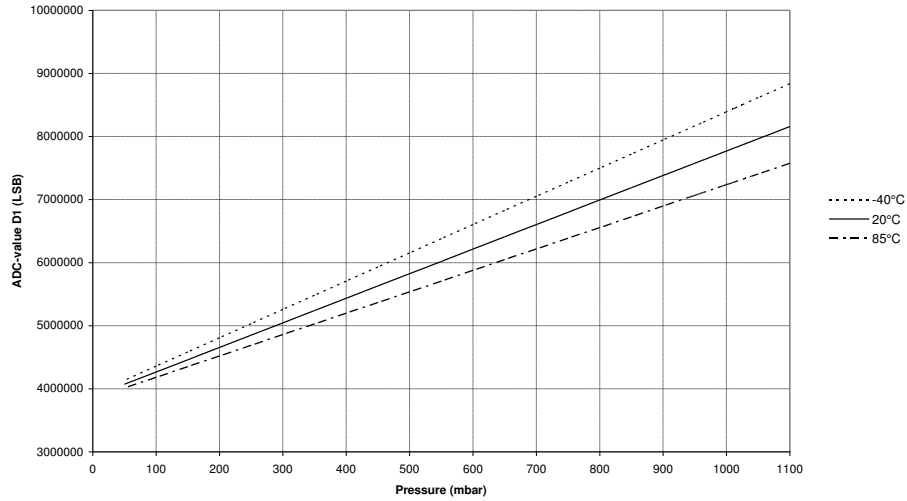

ADC-value D2 vs Temperature (typical)

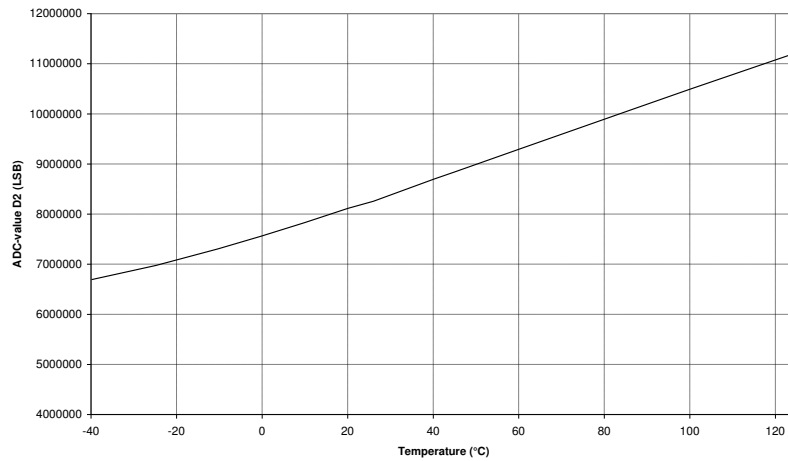

TYPICAL PERFORMANCE CHARACTERISTICS (CONTINUED)

Absolute Pressure Accuracy after Calibration, 2nd order compensation

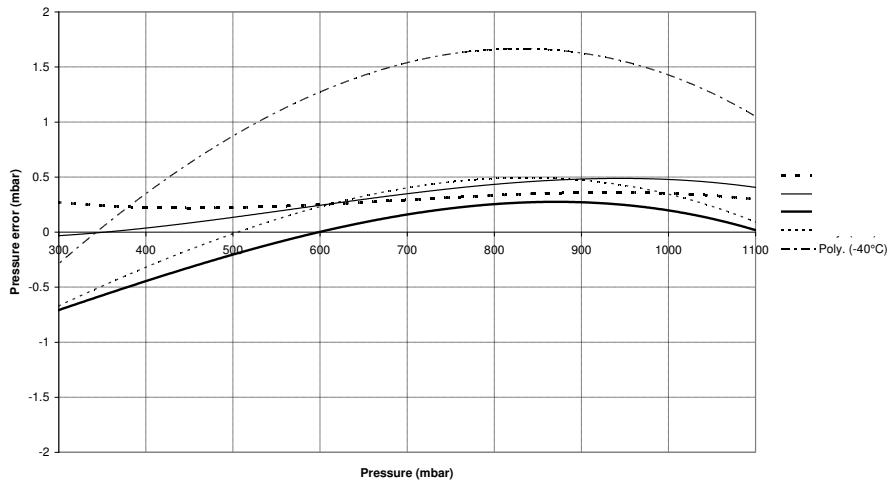

Pressure Error Accuracy vs temperature (typical)

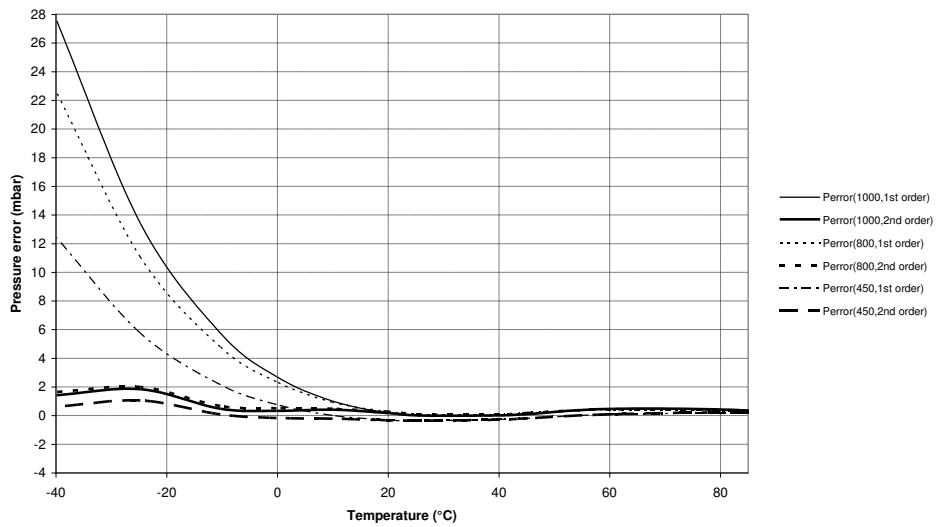

Temperature Error Accuracy vs temperature (typical)

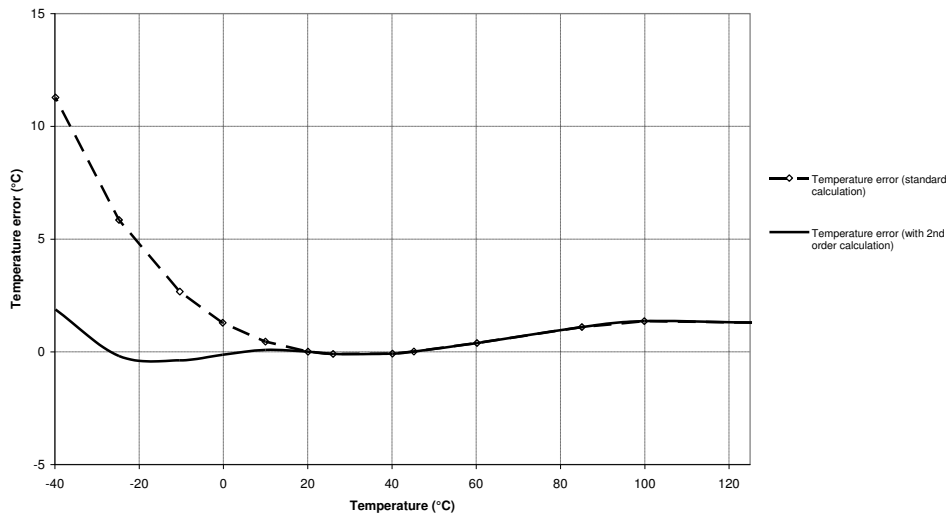

TYPICAL PERFORMANCE CHARACTERISTICS (CONTINUED)

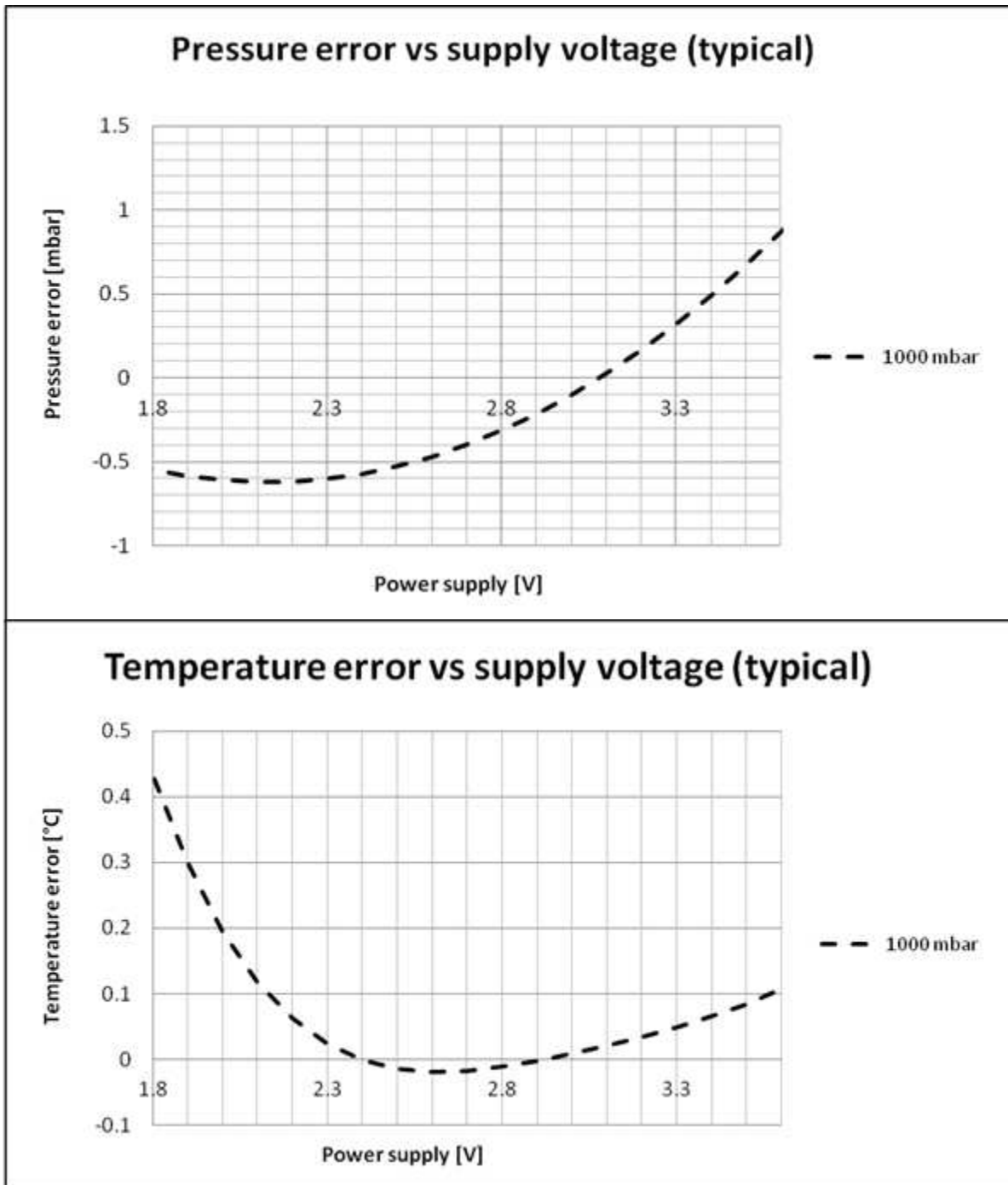

MS5611-01BA03

Barometric Pressure Sensor, with stainless steel cap

ORDERING INFORMATION

PART NUMBER	DESCRIPTION	Art. No	Delivery Form
MS5611-01BA03	Barometric Pressure Sensor with Thin Metal Cap	MS561101BA03-50	Tape and Reel

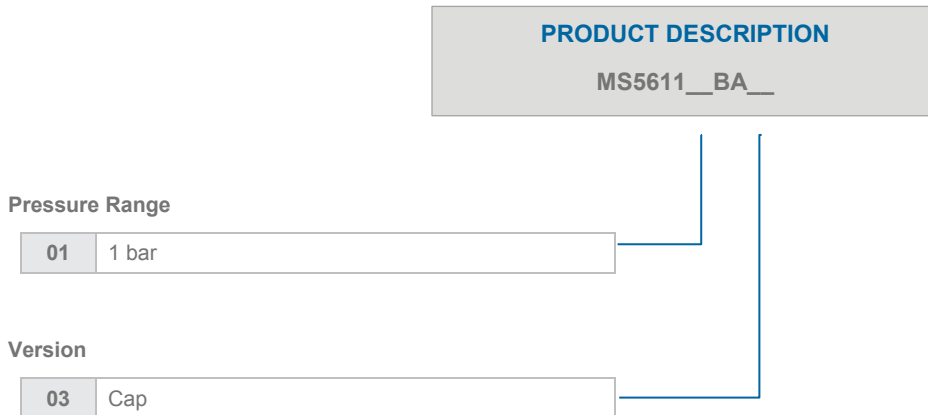

NORTH AMERICA

Measurement Specialties, Inc.,
a TE Connectivity company
Tel: +1 800-522-6752
Email: customercare.frm@te.com

EUROPE

Measurement Specialties (Europe), Ltd.,
a TE Connectivity Company
Tel: +31 73 624 6999
Email: customercare.bevx@te.com

ASIA

Measurement Specialties (China) Ltd.,
a TE Connectivity company
Tel: +86 0400-820-6015
Email: customercare.shzn@te.com

TE.com/sensorsolutions

Measurement Specialties, Inc., a TE Connectivity company.

Measurement Specialties, TE Connectivity, TE Connectivity (logo) and EVERY CONNECTION COUNTS are trademarks. All other logos, products and/or company names referred to herein might be trademarks of their respective owners.

The information given herein, including drawings, illustrations and schematics which are intended for illustration purposes only, is believed to be reliable. However, TE Connectivity makes no warranties as to its accuracy or completeness and disclaims any liability in connection with its use. TE Connectivity's obligations shall only be as set forth in TE Connectivity's Standard Terms and Conditions of Sale for this product and in no case will TE Connectivity be liable for any incidental, indirect or consequential damages arising out of the sale, resale, use or misuse of the product. Users of TE Connectivity products should make their own evaluation to determine the suitability of each such product for the specific application.

© 2015 TE Connectivity Ltd. family of companies All Rights Reserved.

单击下面可查看定价，库存，交付和生命周期等信息

[>>TE Connectivity\(泰科\)](#)