

4 PIN SSOP PHOTOTRANSISTOR PHOTOCOUPLER AC INPUT PHOTOCOUPLER EL3H4-G Series

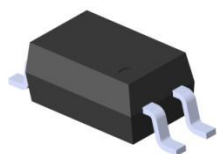

Schematic

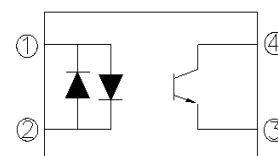

Pin Configuration

1. Anode / Cathode
2. Cathode / Anode
3. Emitter
4. Collector

Features

- Compliance Halogen Free
(Br < 900 ppm, Cl < 900 ppm, Br+Cl < 1500 ppm)
- AC input response
- Current transfer ratio
(CTR: Min. 20% at $I_F = \pm 1\text{mA}$, $V_{CE} = 5\text{V}$)
- High isolation voltage between input and output (Viso = 3750 V rms)
- Compact small outline package
- Compliance with EU REACH
- The product itself will remain within RoHS compliant version
- UL and cUL approved(No. E214129)
- VDE approved (No. 132249)
- SEMKO approved
- NEMKO approved
- DEMKO approved
- FIMKO approved
- CQC approved

Description

The EL3H4-G series contains two infrared emitting diode, connected in inverse parallel, optically coupled to a phototransistor encapsulated with green compound. It is packaged in a 4-pin small outline SMD package

Applications

- AC line monitor
- Programmable controllers
- Telephone line interface
- Unknown polarity DC sensor

Absolute Maximum Ratings (Ta=25°C)

	Parameter	Symbol	Rating	Unit
Input	Forward current	I_F	±50	mA
	Peak forward current (t = 10µs)	I_{FM}	1	A
	Power Dissipation No derating required up to $T_a = 100^\circ\text{C}$	P_D	70	mW
Output	Power dissipation	P_C	150	mW
	Derating factor (above $T_a = 80^\circ\text{C}$)		3.7	mW/°C
	Collector-Emitter voltage	V_{CEO}	80	V
	Emitter-Collector voltage	V_{ECO}	6	V
Total Power Dissipation		P_{TOT}	200	mW
Isolation Voltage*1		V_{ISO}	3750	V rms
Operating Temperature		T_{OPR}	-55 to 100	°C
Storage Temperature		T_{STG}	-55 to 125	°C
Soldering Temperature*2		T_{SOL}	260	°C

Notes

*1 AC for 1 minute, R.H.= 40 ~ 60% R.H. In this test, pins 1, 2 are shorted together, and pins 3, 4 are shorted together.

*2 For 10 seconds.

Electro-Optical Characteristics (Ta=25°C unless specified otherwise)

Input

Parameter	Symbol	Min.	Typ.	Max.	Unit	Condition
Forward Voltage	V_F	-	1.2	1.4	V	$I_F = \pm 20\text{mA}$
Input capacitance	C_{in}	-	50	250	pF	$V = 0, f = 1\text{kHz}$

Output

Parameter	Symbol	Min	Typ.	Max.	Unit	Condition
Collector-Emitter dark current	I_{CEO}	-	-	100	nA	$V_{CE} = 20\text{V}, I_F = 0\text{mA}$
Collector-Emitter breakdown voltage	BV_{CEO}	80	-	-	V	$I_C = 0.1\text{mA}$
Emitter-Collector breakdown voltage	BV_{ECO}	6	-	-	V	$I_E = 0.01\text{mA}$

Transfer Characteristics

Parameter	Symbol	Min	Typ.	Max.	Unit	Condition
Current Transfer ratio	EL3H4	20	-	300	%	$I_F = \pm 1\text{mA}, V_{CE} = 5\text{V}$
	EL3H4A	50	-	150		
	EL3H4B	100	-	300		
CTR Symmetry		0.5		2.0		$I_F = \pm 1\text{mA}, V_{CE} = 5\text{V}$
Collector-Emitter saturation voltage	$V_{CE(sat)}$	-	0.1	0.2	V	$I_F = \pm 20\text{mA}, I_C = 1\text{mA}$
Isolation resistance	R_{IO}	5×10^{10}	10^{11}	-	Ω	$V_{IO} = 500\text{Vdc}, 40\sim 60\% \text{ R.H.}$
Floating capacitance	C_{IO}	-	0.6	1.0	pF	$V_{IO} = 0, f = 1\text{MHz}$
Rise time	t_r	-	-	18	μs	$V_{CE} = 2\text{V}, I_C = 2\text{mA}, R_L = 100\Omega$
Fall time	t_f	-	-	18	μs	

* Typical values at $T_a = 25^\circ\text{C}$

Typical Electro-Optical Characteristics Curves

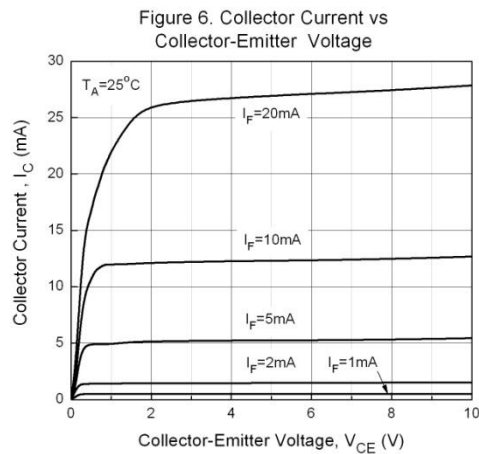
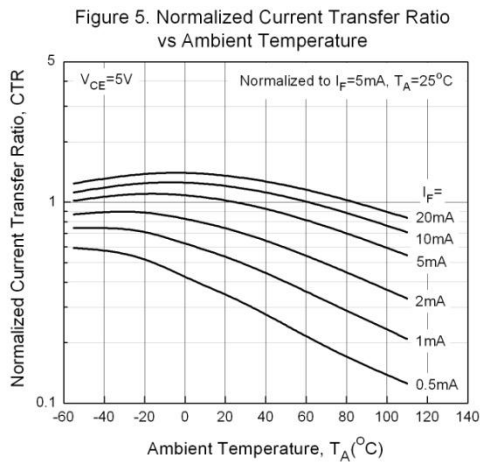
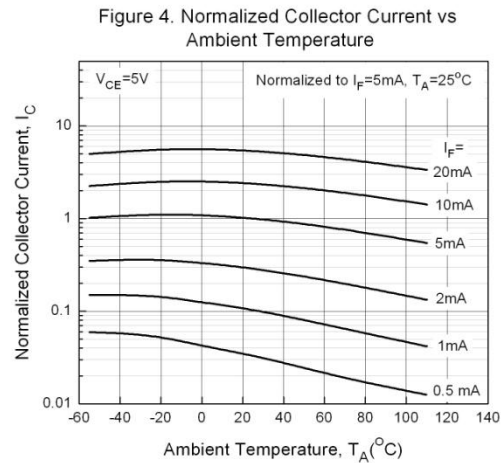
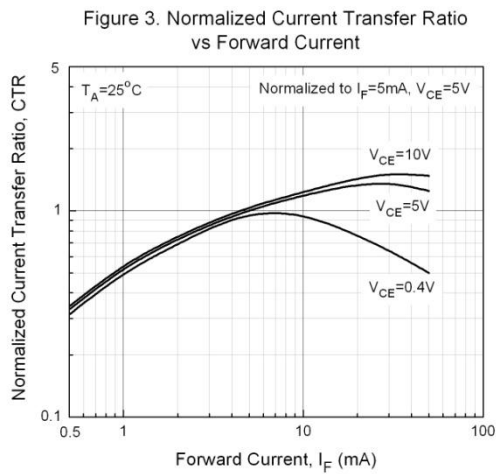
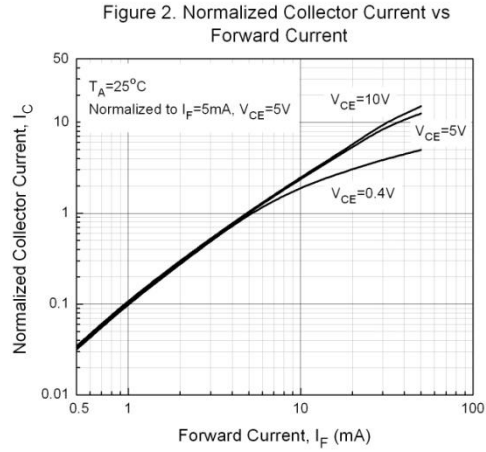
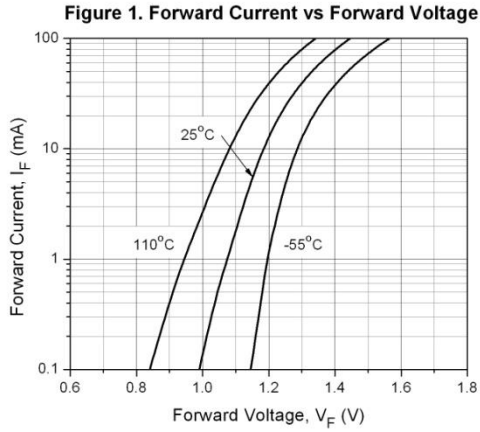

Figure 7. Collector Current vs Collector-Emitter Voltage

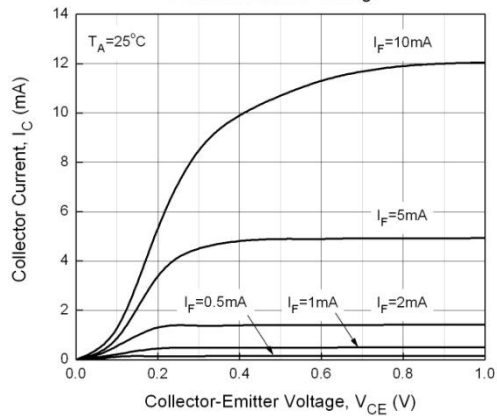

Figure 8. Collector Dark Current vs Ambient Temperature

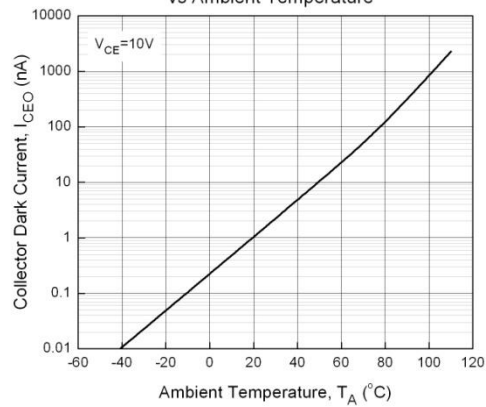

Figure 9. Collector-Emitter Saturation Voltage vs Ambient Temperature

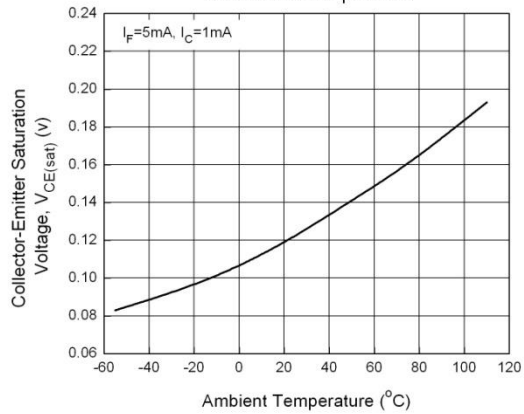

Figure 10. Switching Time vs Load Resistance

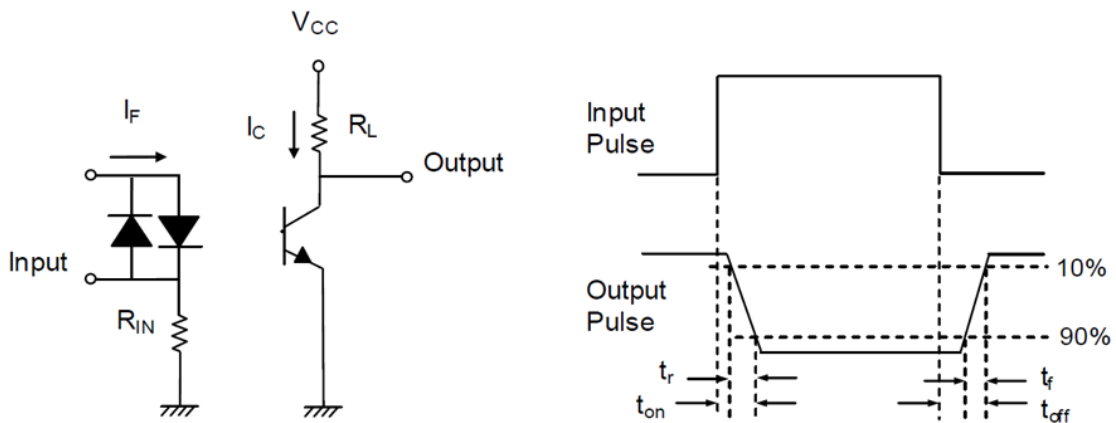
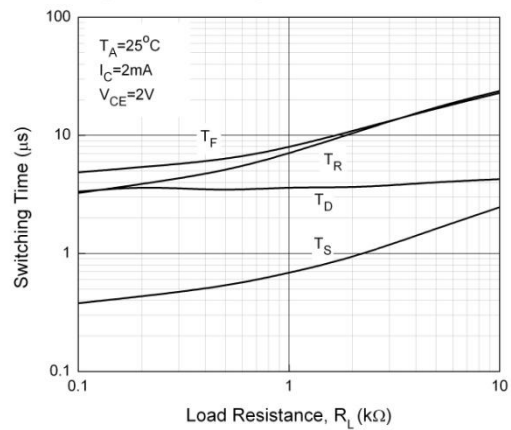

Figure 11. Switching Time Test Circuit & Waveforms

Order Information

Part Number

EL3H4(Y)(Z)-VG

Notes

- Y = CTR Rank (A, B or none)
- Z = Tape and reel option (TA, TB, EA, EB or none).
- V = VDE (optional)
- G = Halogens free

Option	Description	Packing quantity
None	Standard SMD option	150 units per tube
-V	Standard SMD option + VDE	150 units per tube
(TA)	TA Tape & reel option	5000 units per reel
(TB)	TB Tape & reel option	5000 units per reel
(TA)-V	TA Tape & reel option + VDE	5000 units per reel
(TB)-V	TB Tape & reel option + VDE	5000 units per reel
(EA)	TA Tape & reel option	1000 units per reel
(EB)	TB Tape & reel option	1000 units per reel
(EA)-V	TA Tape & reel option + VDE	1000 units per reel
(EB)-V	TB Tape & reel option + VDE	1000 units per reel

Package Dimension (Dimensions in mm)

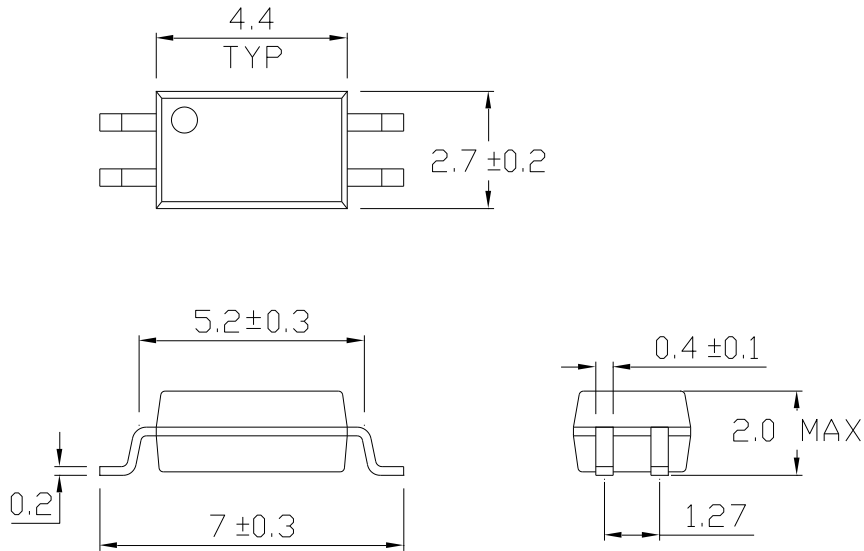

Recommended pad layout for surface mount leadform

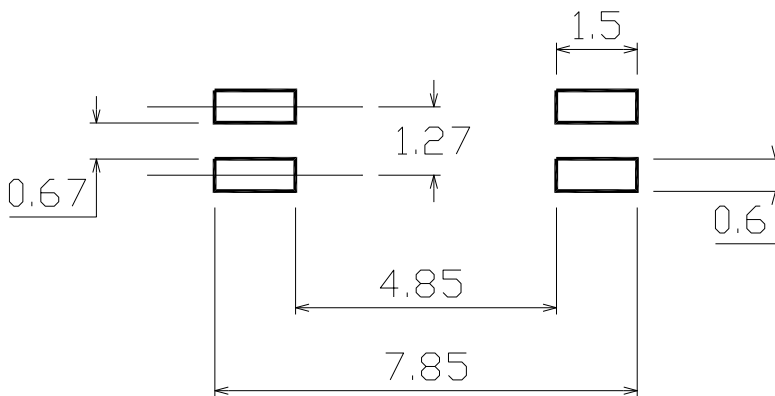

Notes

Suggested pad dimension is just for reference only.
Please modify the pad dimension based on individual need.

Device Marking



Notes

EL	denotes EVERLIGHT
3H4	denotes Device Number
R	denotes CTR Rank (A, B or none)
Y	denotes 1 digit Year code
WW	denotes 2 digit Week code
V	denotes VDE (optional)

Tape & Reel Packing Specifications

Option TA

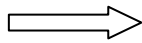
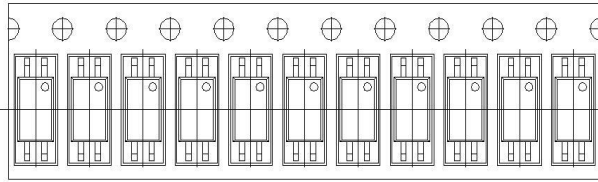

Direction of feed from reel

Option TB

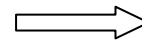
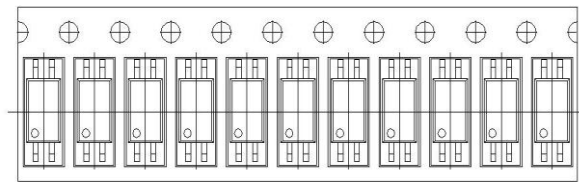

Direction of feed from reel

Tape dimensions

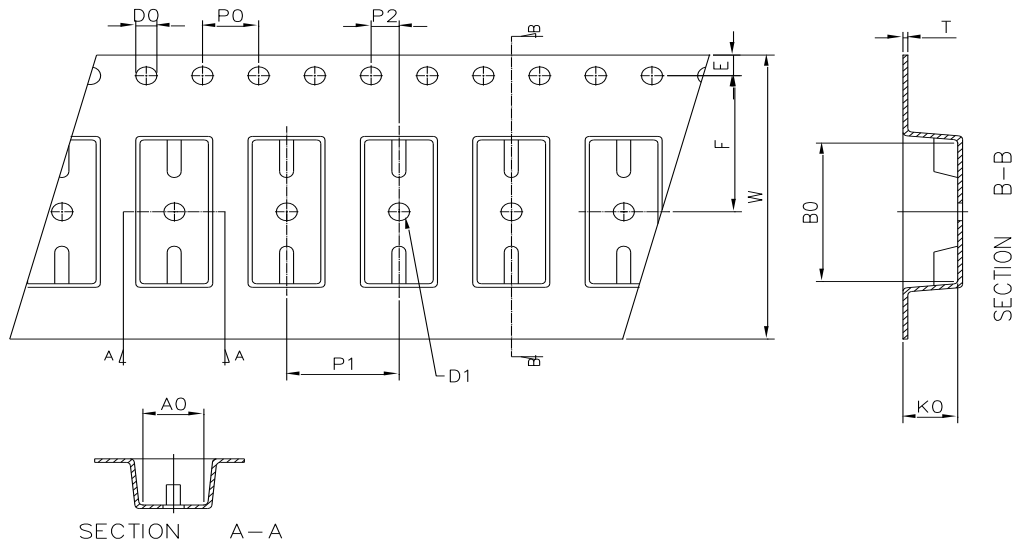

Dimension No.	A0	B0	D0	D1	E	F
Dimension (mm)	3.00 ± 0.10	7.45 ± 0.10	1.50 + 0.1/-0	1.50 ± 0.10	1.75 ± 0.10	5.50 ± 0.10
Dimension No.	P0	P1	P2	t	W	K0
Dimension (mm)	4.00 ± 0.15	4.00 ± 0.10	2.00 ± 0.10	0.30 ± 0.05	12.1 ± 0.2	2.45 ± 0.1

Precautions for Use

1. Soldering Condition

1.1 (A) Maximum Body Case Temperature Profile for evaluation of Reflow Profile

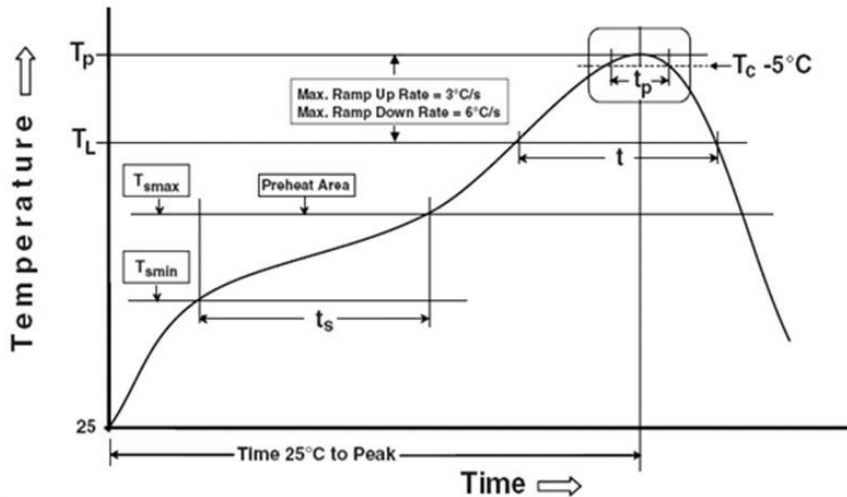

Notes

Reference: IPC/JEDEC J-STD-020D

Preheat

Temperature min (T_{smin})	150 °C
Temperature max (T_{smax})	200°C
Time (T_{smin} to T_{smax}) (t_s)	60-120 seconds
Average ramp-up rate (T_{smax} to T_p)	3 °C/second max

Other

Liquidus Temperature (T_L)	217 °C
Time above Liquidus Temperature (t_L)	60-100 sec
Peak Temperature (T_p)	260°C
Time within 5 °C of Actual Peak Temperature: $T_p - 5^\circ\text{C}$	30 s
Ramp- Down Rate from Peak Temperature	6°C /second max.
Time 25°C to peak temperature	8 minutes max.
Reflow times	3 times

DISCLAIMER

1. Above specification may be changed without notice. EVERLIGHT will reserve authority on material change for above specification.
2. When using this product, please observe the absolute maximum ratings and the instructions for using outlined in these specification sheets. EVERLIGHT assumes no responsibility for any damage resulting from use of the product which does not comply with the absolute maximum ratings and the instructions included in these specification sheets.
3. These specification sheets include materials protected under copyright of EVERLIGHT corporation. Please don't reproduce or cause anyone to reproduce them without EVERLIGHT's consent.
4. These specification sheets include materials protected under copyright of EVERLIGHT. Reproduction in any form is prohibited without the specific consent of EVERLIGHT.
5. This product is not intended to be used for military, aircraft, automotive, medical, life sustaining or life saving applications or any other application which can result in human injury or death. Please contact authorized Everlight sales agent for special application request.
6. Statements regarding the suitability of products for certain types of applications are based on Everlight's knowledge of typical requirements that are often placed on Everlight products in generic applications. Such statements are not binding statements about the suitability of products for a particular application. It is the customer's responsibility to validate that a particular product with the properties described in the product specification is suitable for use in a particular application. Parameters provided in datasheets and/or specifications may vary in different applications and performance may vary over time. All operating parameters, including typical parameters, must be validated for each customer application by the customer's technical experts. Product specifications do not expand or otherwise modify Everlight's terms and conditions of purchase, including but not limited to the warranty expressed therein.

单击下面可查看定价，库存，交付和生命周期等信息

[>>Everlight \(亿光\)](#)