

V_{DSS}	1200V
$R_{DS(on)}$ (Typ.)	450mΩ
I_D	10A
P_D	85W

●Features

- 1) Low on-resistance
- 2) Fast switching speed
- 3) Fast reverse recovery
- 4) Easy to parallel
- 5) Simple to drive
- 6) Pb-free lead plating ; RoHS compliant

●Application

- Solar inverters
- DC/DC converters
- Switch mode power supplies
- Induction heating
- Motor drives

●Absolute maximum ratings (Ta = 25°C)

Parameter		Symbol	Value	Unit
Drain - Source voltage		V_{DSS}	1200	V
Continuous drain current	$T_c = 25^\circ\text{C}$	I_D^{*1}	10	A
	$T_c = 100^\circ\text{C}$	I_D^{*1}	7	A
Pulsed drain current		$I_{D,pulse}^{*2}$	25	A
Gate - Source voltage (DC)		V_{GSS}	-6 to 22	V
Gate - Source surge voltage ($T_{surge} < 300\text{nsec}$)		$V_{GSS-surge}^{*3}$	-10 to 26	V
Power dissipation ($T_c = 25^\circ\text{C}$)		P_D	85	W
Junction temperature		T_j	175	°C
Range of storage temperature		T_{stg}	-55 to +175	°C

●Outline

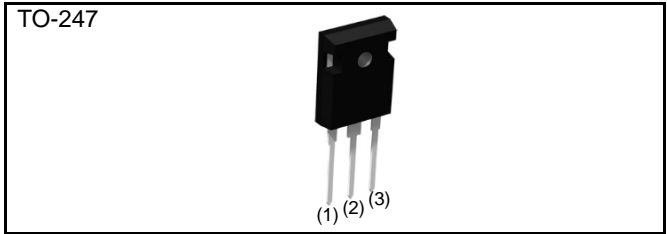

●Inner circuit

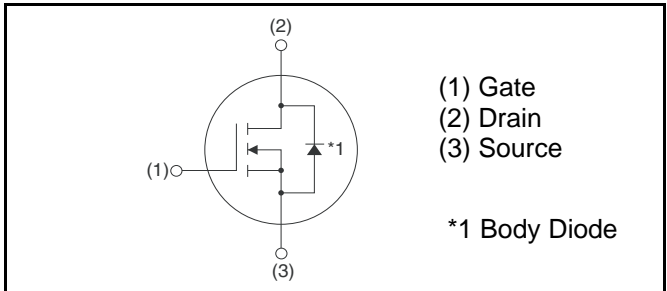

●Packaging specifications

Type	Packaging	Tube
	Reel size (mm)	-
	Tape width (mm)	-
	Basic ordering unit (pcs)	30
	Packing code	C
	Marking	SCT2450KE

● Thermal resistance

Parameter	Symbol	Values			Unit
		Min.	Typ.	Max.	
Thermal resistance, junction - case	R_{thJC}	-	1.36	1.77	°C/W
Thermal resistance, junction - ambient	R_{thJA}	-	-	50	°C/W
Soldering temperature, wavesoldering for 10s	T_{sold}	-	-	265	°C

● Electrical characteristics ($T_a = 25^\circ\text{C}$)

Parameter	Symbol	Conditions	Values			Unit
			Min.	Typ.	Max.	
Drain - Source breakdown voltage	$V_{(BR)DSS}$	$V_{GS} = 0V, I_D = 1mA$	1200	-	-	V
Zero gate voltage drain current	I_{DSS}	$V_{DS} = 1200V, V_{GS} = 0V$	-	1	10	μA
		$T_j = 150^\circ\text{C}$	-	2	-	
Gate - Source leakage current	I_{GSS+}	$V_{GS} = +22V, V_{DS} = 0V$	-	-	100	nA
Gate - Source leakage current	I_{GSS-}	$V_{GS} = -6V, V_{DS} = 0V$	-	-	-100	nA
Gate threshold voltage	$V_{GS(th)}$	$V_{DS} = V_{GS}, I_D = 0.9mA$	1.6	2.8	4.0	V

*1 Limited only by maximum temperature allowed.

*2 $PW \leq 10\mu\text{s}$, Duty cycle $\leq 1\%$

*3 Example of acceptable Vgs waveform

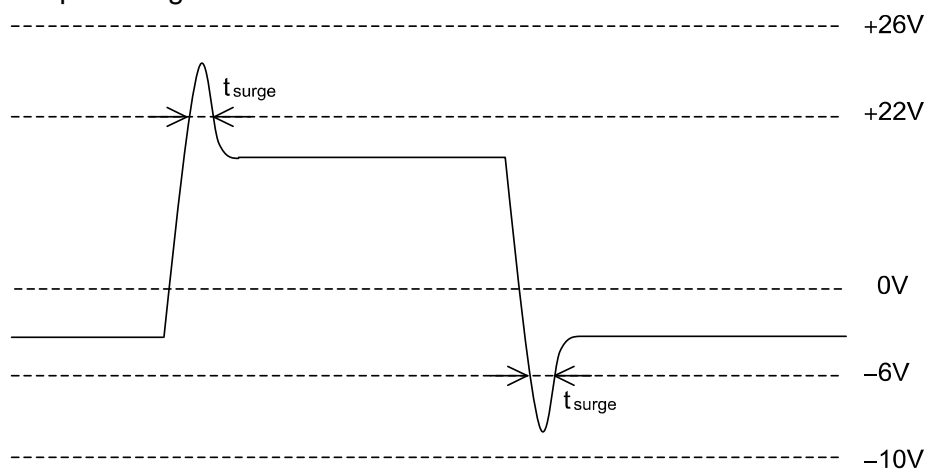

*4 Pulsed

●Electrical characteristics (T_a = 25°C)

Parameter	Symbol	Conditions	Values			Unit
			Min.	Typ.	Max.	
Static drain - source on - state resistance	R _{DS(on)} ^{*4}	V _{GS} = 18V, I _D = 3A	-	450	585	mΩ
		T _J = 25°C	-	610	-	
		T _J = 125°C	-	-	-	
Gate input resistance	R _G	f = 1MHz, open drain	-	25	-	Ω
Transconductance	g _{fs} ^{*4}	V _{DS} = 10V, I _D = 3A	-	1.0	-	S
Input capacitance	C _{iss}	V _{GS} = 0V	-	463	-	pF
Output capacitance	C _{oss}	V _{DS} = 800V	-	21	-	
Reverse transfer capacitance	C _{rss}	f = 1MHz	-	4	-	
Effective output capacitance, energy related	C _{o(er)}	V _{GS} = 0V V _{DS} = 0V to 500V	-	31	-	pF
Turn - on delay time	t _{d(on)} ^{*4}	V _{DD} = 400V, V _{GS} = 18V	-	19	-	ns
Rise time	t _r ^{*4}	I _D = 3A	-	17	-	
Turn - off delay time	t _{d(off)} ^{*4}	R _L = 133Ω	-	38	-	
Fall time	t _f ^{*4}	R _G = 0Ω	-	34	-	
Turn - on switching loss	E _{on} ^{*4}	V _{DD} = 600V, I _D = 3A V _{GS} = 18V/0V	-	47	-	μJ
Turn - off switching loss	E _{off} ^{*4}	R _G = 0Ω, L = 500μH *E _{on} includes diode reverse recovery	-	17	-	

●Gate Charge characteristics (T_a = 25°C)

Parameter	Symbol	Conditions	Values			Unit
			Min.	Typ.	Max.	
Total gate charge	Q _g ^{*4}	V _{DD} = 400V	-	27	-	nC
Gate - Source charge	Q _{gs} ^{*4}	I _D = 3A	-	7	-	
Gate - Drain charge	Q _{gd} ^{*4}	V _{GS} = 18V	-	9	-	
Gate plateau voltage	V _(plateau)	V _{DD} = 400V, I _D = 3A	-	10.5	-	V

●Body diode electrical characteristics (Source-Drain) ($T_a = 25^\circ\text{C}$)

Parameter	Symbol	Conditions	Values			Unit
			Min.	Typ.	Max.	
Inverse diode continuous, forward current	I_S^{*1}	$T_C = 25^\circ\text{C}$	-	-	10	A
Inverse diode direct current, pulsed	I_{SM}^{*2}		-	-	25	A
Forward voltage	V_{SD}^{*4}	$V_{GS} = 0\text{V}, I_S = 3\text{A}$	-	4.3	-	V
Reverse recovery time	t_{rr}^{*4}	$I_F = 3\text{A}, V_R = 400\text{V}$ $di/dt = 110\text{A}/\mu\text{s}$	-	19	-	ns
Reverse recovery charge	Q_{rr}^{*4}		-	13	-	nC
Peak reverse recovery current	I_{rrm}^{*4}		-	1.4	-	A

●Typical Transient Thermal Characteristics

Symbol	Value	Unit
R_{th1}	230m	K/W
R_{th2}	687m	
R_{th3}	441m	

Symbol	Value	Unit
C_{th1}	219 μ	Ws/K
C_{th2}	1.29m	
C_{th3}	13.1m	

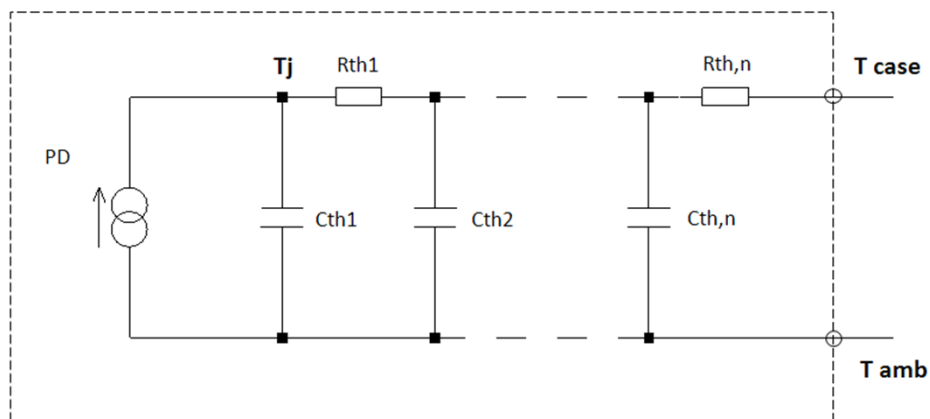

●Electrical characteristic curves

Fig.1 Power Dissipation Derating Curve

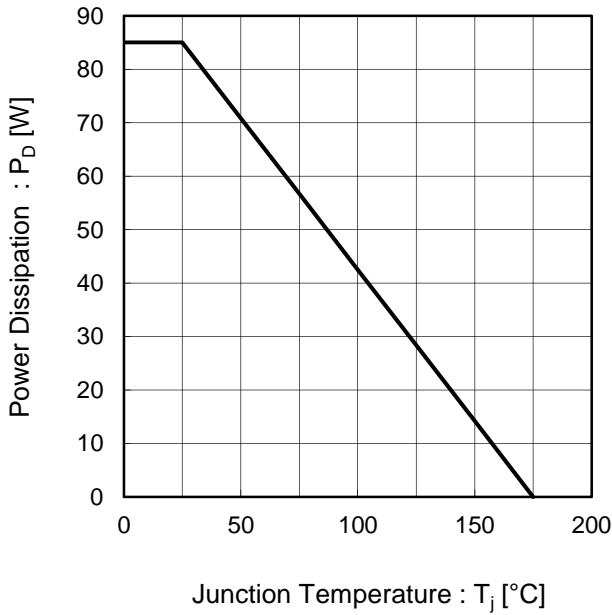

Fig.2 Maximum Safe Operating Area

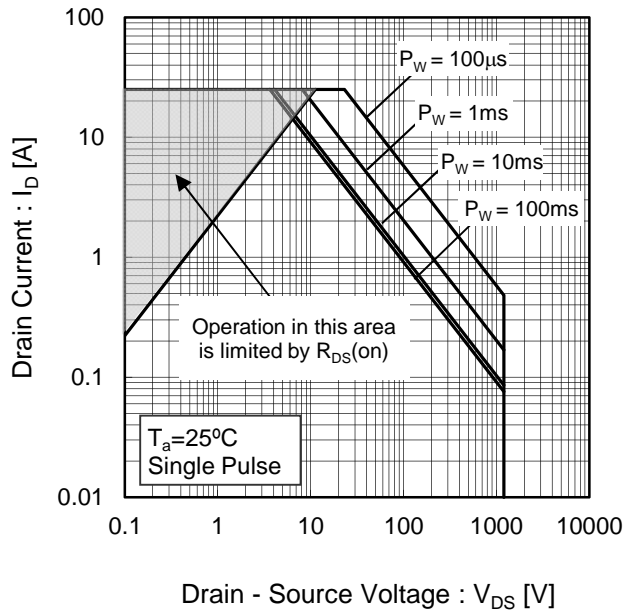
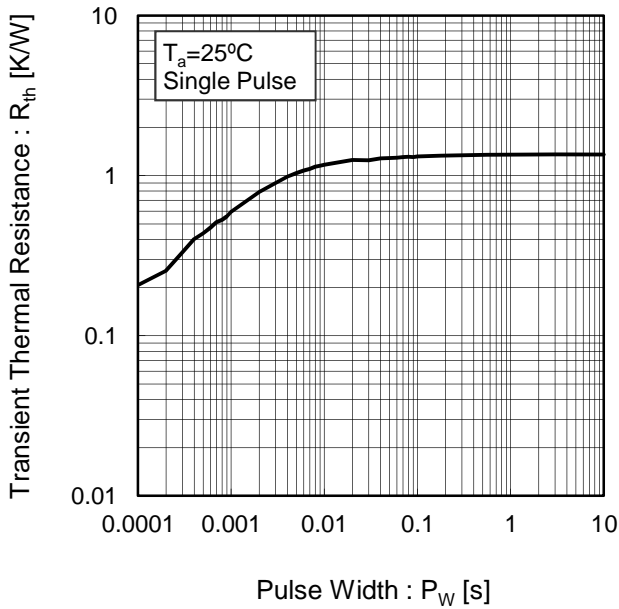

Fig.3 Typical Transient Thermal Resistance vs. Pulse Width



●Electrical characteristic curves

Fig.4 Typical Output Characteristics(I)

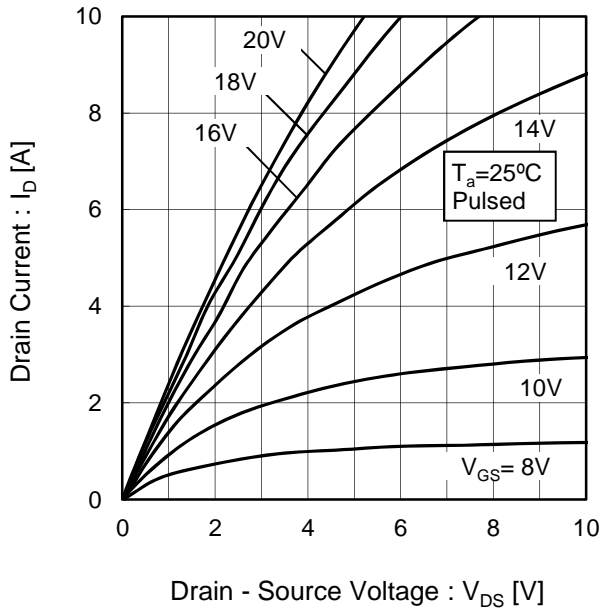

Fig.5 Typical Output Characteristics(II)

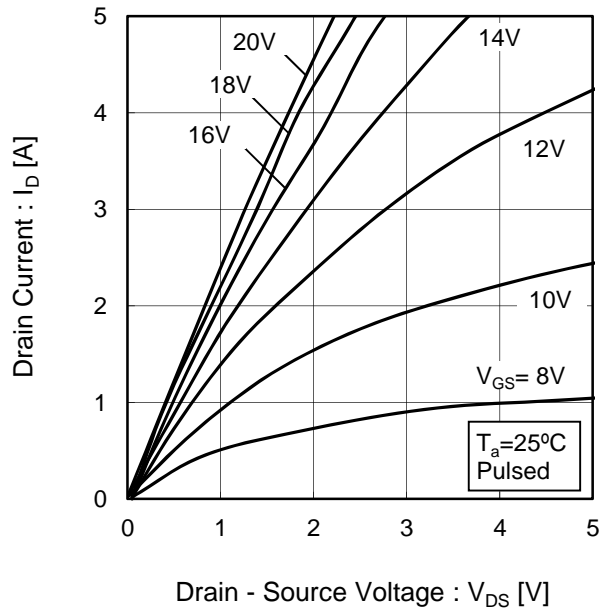

Fig.6 $T_j = 150^\circ\text{C}$ Typical Output Characteristics(I)

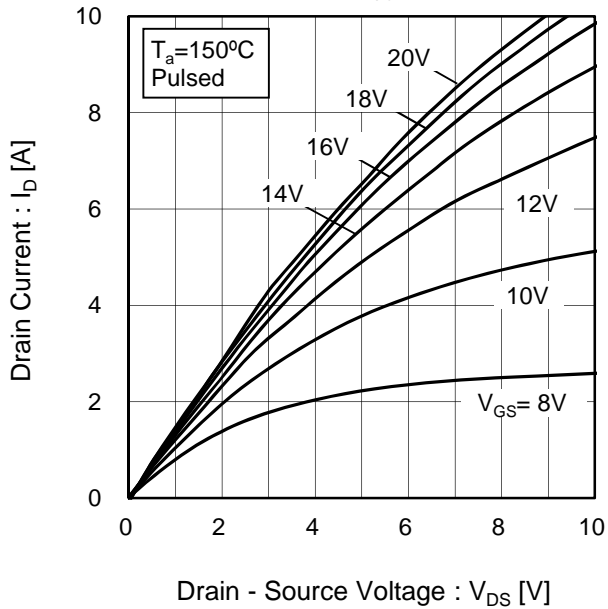
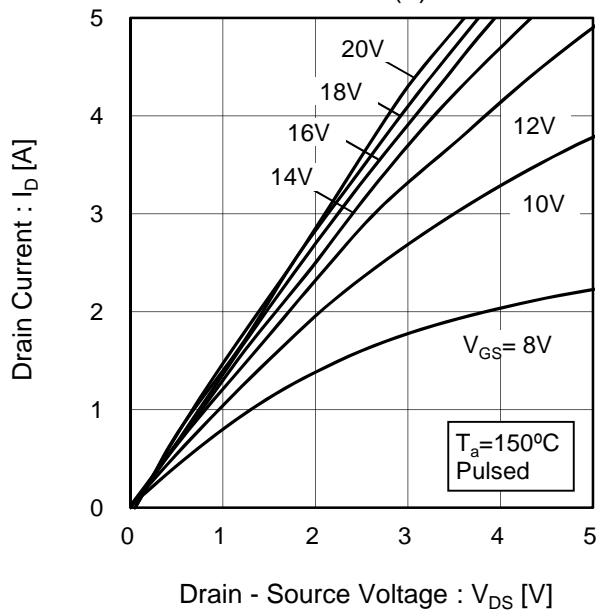

Fig.7 $T_j = 150^\circ\text{C}$ Typical Output Characteristics(II)



●Electrical characteristic curves

Fig.8 Typical Transfer Characteristics (I)

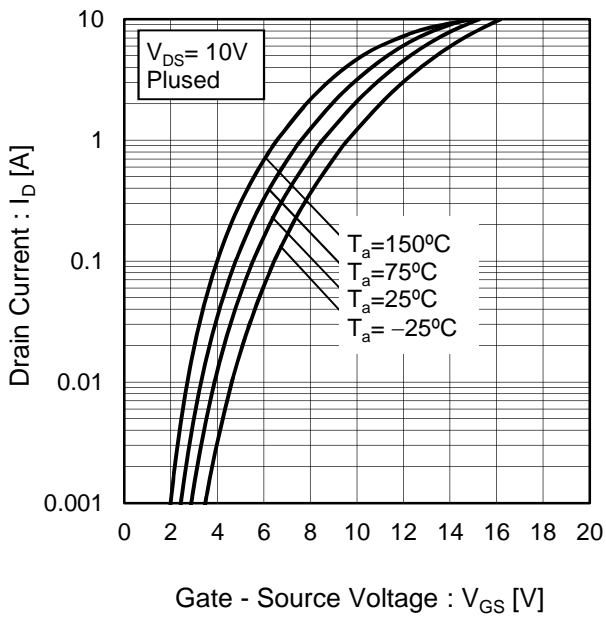

Fig.9 Typical Transfer Characteristics (II)

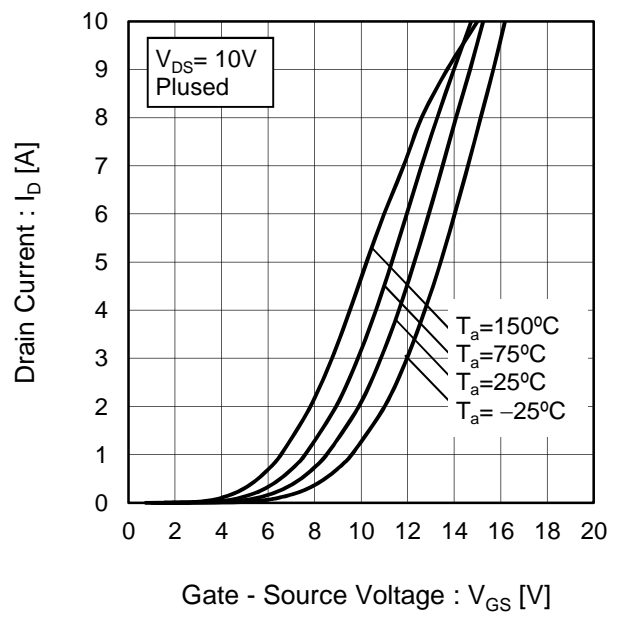

Fig.10 Gate Threshold Voltage vs. Junction Temperature

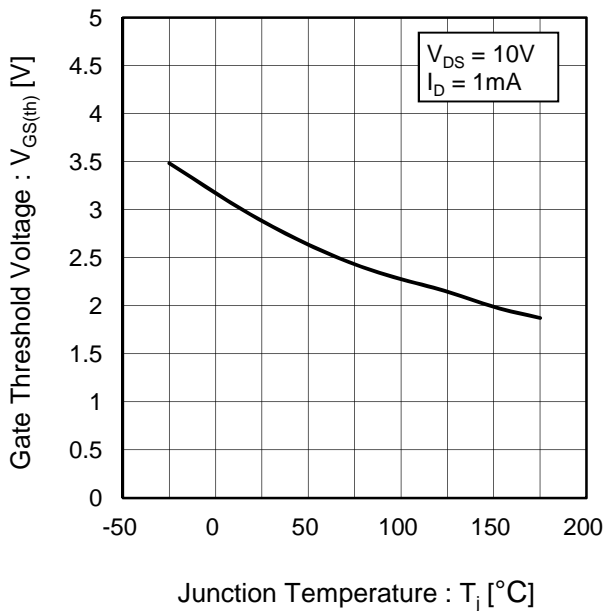
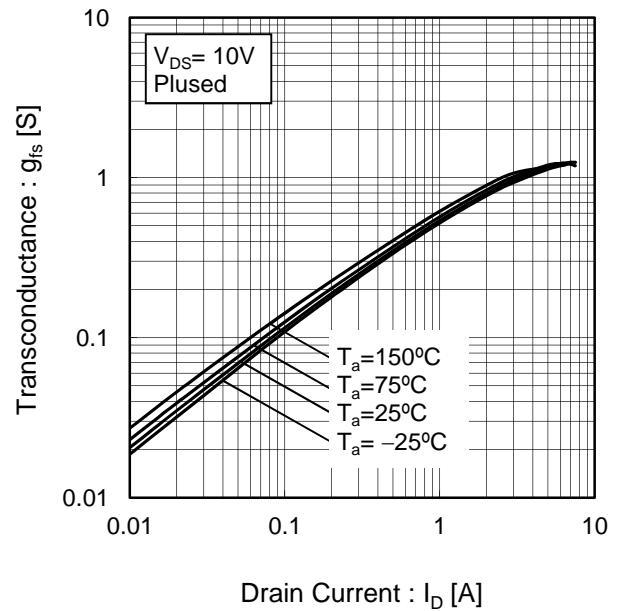

Fig.11 Transconductance vs. Drain Current



●Electrical characteristic curves

Fig.12 Static Drain - Source On - State Resistance vs. Gate Source Voltage

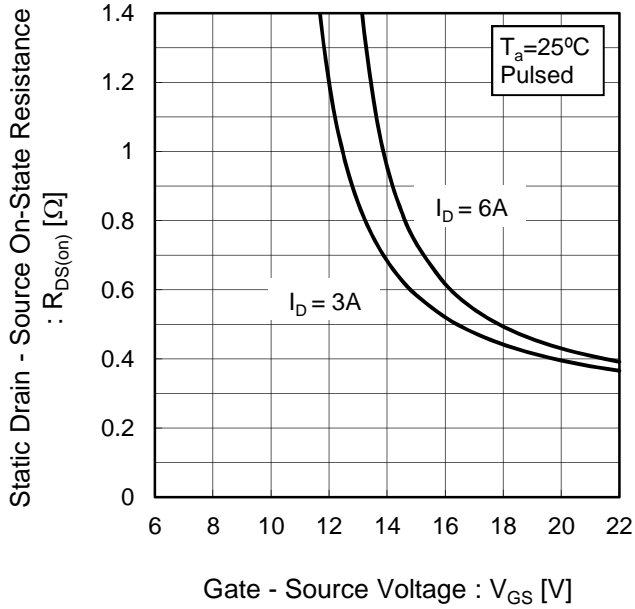

Fig.13 Static Drain - Source On - State Resistance vs. Junction Temperature

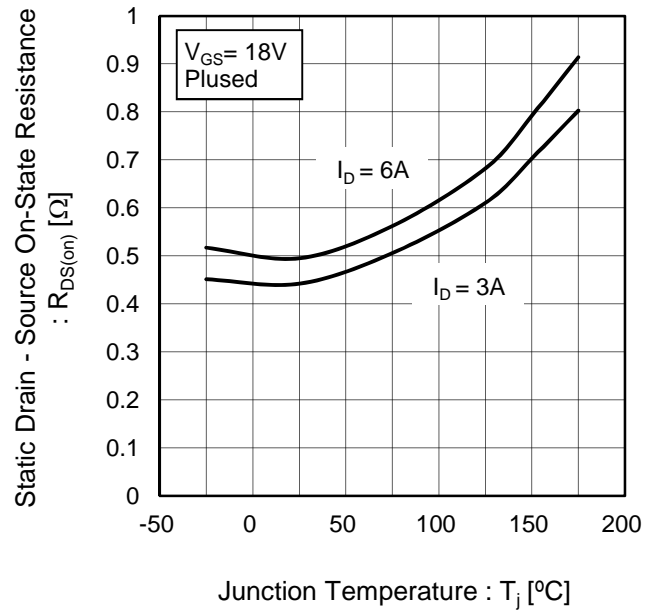
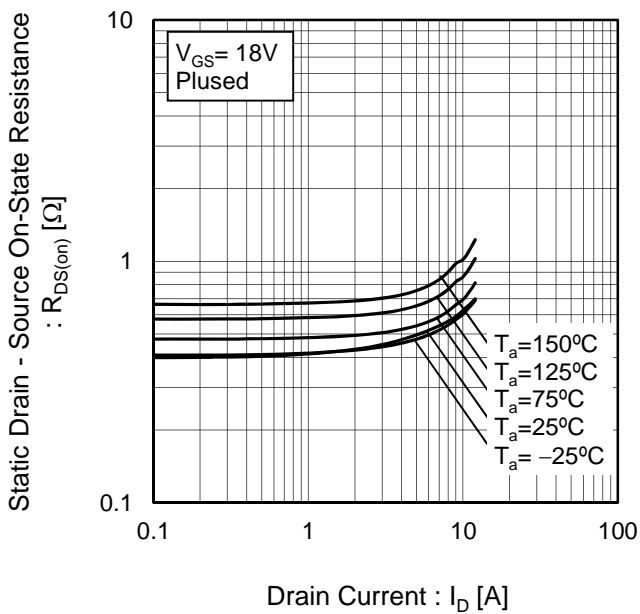

Fig.14 Static Drain - Source On - State Resistance vs. Drain Current



●Electrical characteristic curves

Fig.15 Typical Capacitance vs. Drain - Source Voltage

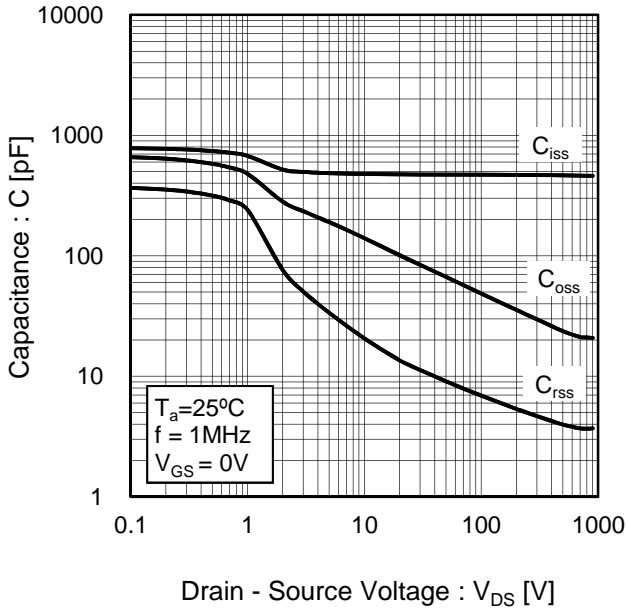

Fig.16 Coss Stored Energy

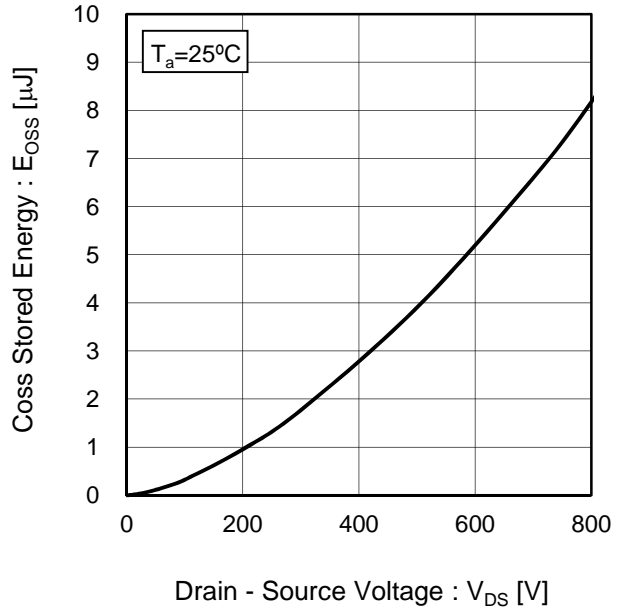

Fig.17 Switching Characteristics

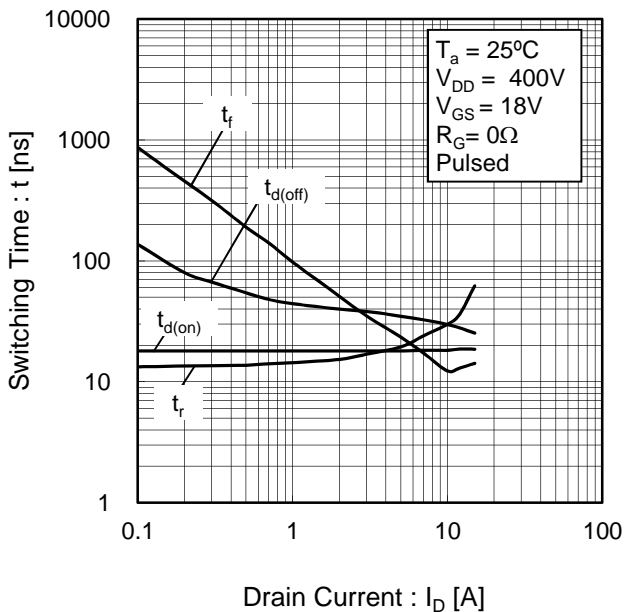
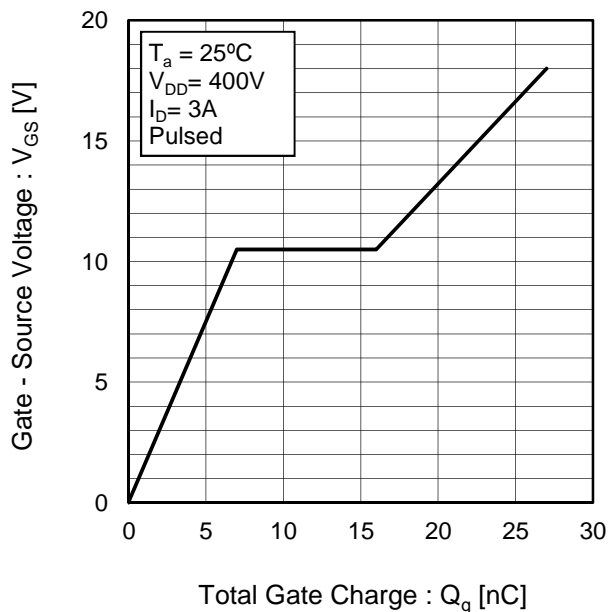

Fig.18 Dynamic Input Characteristics



●Electrical characteristic curves

Fig.19 Typical Switching Loss vs. Drain - Source Voltage

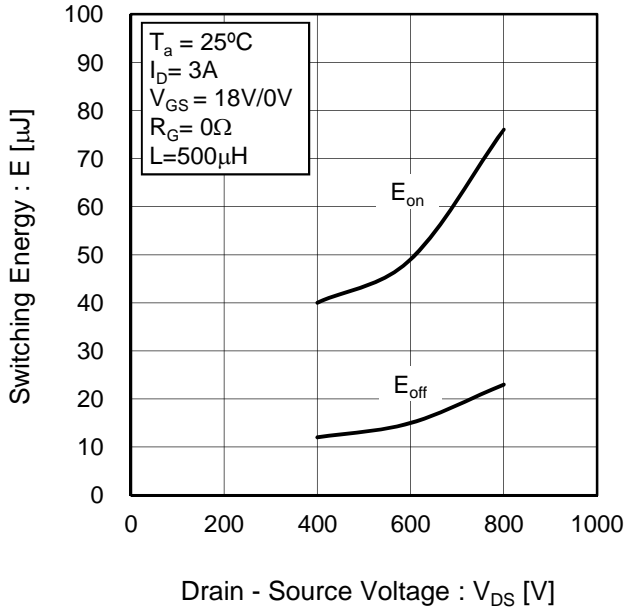

Fig.20 Typical Switching Loss vs. Drain Current

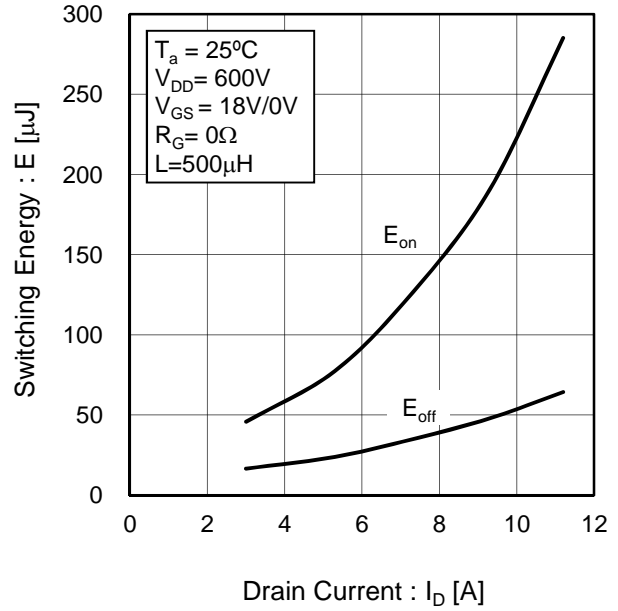
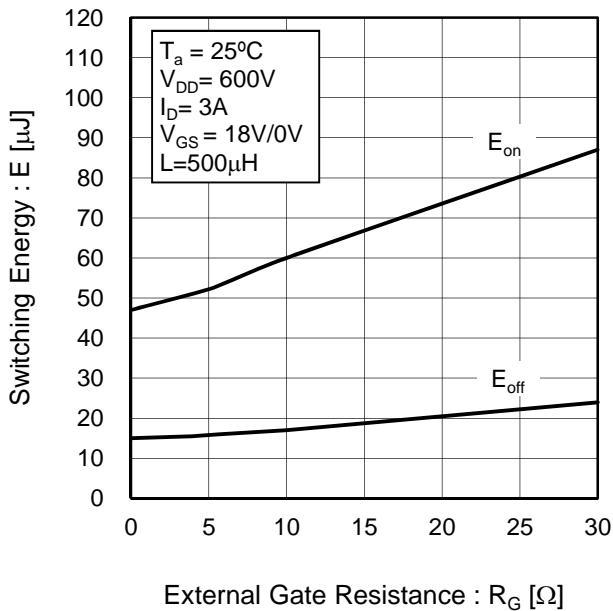

Fig.21 Typical Switching Loss vs. External Gate Resistance



●Electrical characteristic curves

Fig.22 Inverse Diode Forward Current vs. Source - Drain Voltage

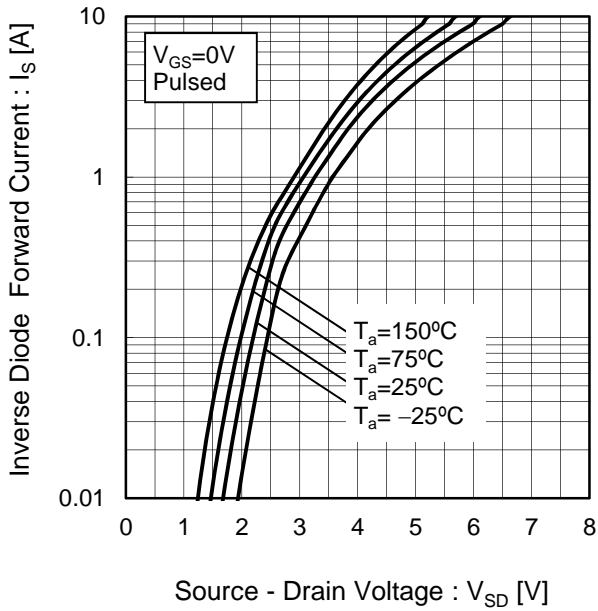
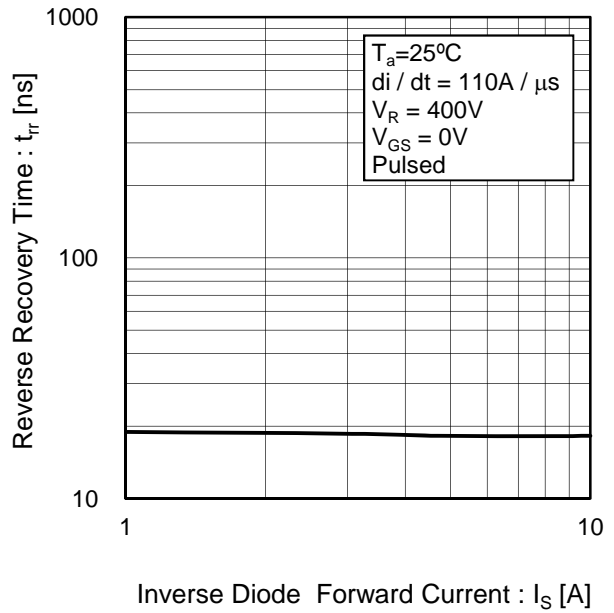

Fig.23 Reverse Recovery Time vs. Inverse Diode Forward Current



●Measurement circuits

Fig.1-1 Switching Time Measurement Circuit



Fig.1-2 Switching Waveforms



Fig.2-1 Gate Charge Measurement Circuit



Fig.2-2 Gate Charge Waveform

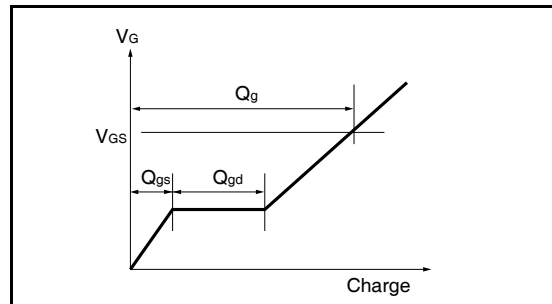

Fig.3-1 Switching Energy Measurement Circuit

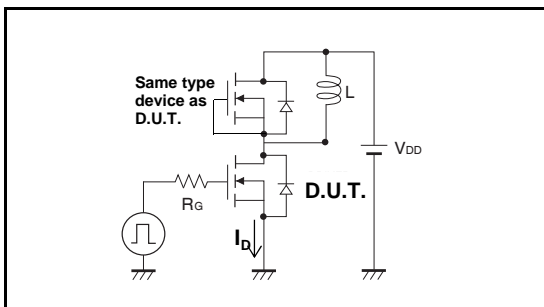

Fig.3-2 Switching Waveforms



Fig.4-1 Reverse Recovery Time Measurement Circuit

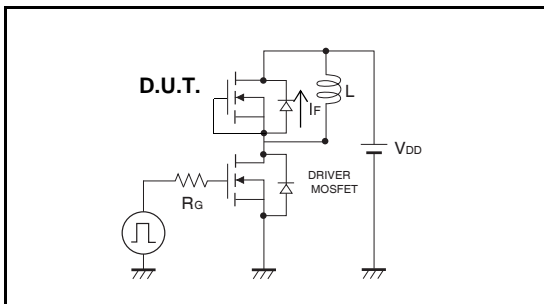
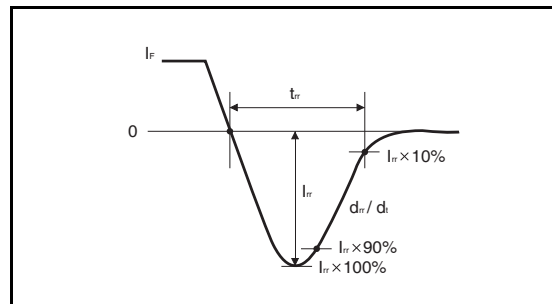

Fig.4-2 Reverse Recovery Waveform



Notes

- 1) The information contained herein is subject to change without notice.
- 2) Before you use our Products, please contact our sales representative and verify the latest specifications :
- 3) Although ROHM is continuously working to improve product reliability and quality, semiconductors can break down and malfunction due to various factors.
Therefore, in order to prevent personal injury or fire arising from failure, please take safety measures such as complying with the derating characteristics, implementing redundant and fire prevention designs, and utilizing backups and fail-safe procedures. ROHM shall have no responsibility for any damages arising out of the use of our Products beyond the rating specified by ROHM.
- 4) Examples of application circuits, circuit constants and any other information contained herein are provided only to illustrate the standard usage and operations of the Products. The peripheral conditions must be taken into account when designing circuits for mass production.
- 5) The technical information specified herein is intended only to show the typical functions of and examples of application circuits for the Products. ROHM does not grant you, explicitly or implicitly, any license to use or exercise intellectual property or other rights held by ROHM or any other parties. ROHM shall have no responsibility whatsoever for any dispute arising out of the use of such technical information.
- 6) The Products specified in this document are not designed to be radiation tolerant.
- 7) For use of our Products in applications requiring a high degree of reliability (as exemplified below), please contact and consult with a ROHM representative : transportation equipment (i.e. cars, ships, trains), primary communication equipment, traffic lights, fire/crime prevention, safety equipment, medical systems, and power transmission systems.
- 8) Do not use our Products in applications requiring extremely high reliability, such as aerospace equipment, nuclear power control systems, and submarine repeaters.
- 9) ROHM shall have no responsibility for any damages or injury arising from non-compliance with the recommended usage conditions and specifications contained herein.
- 10) ROHM has used reasonable care to ensure the accuracy of the information contained in this document. However, ROHM does not warrant that such information is error-free, and ROHM shall have no responsibility for any damages arising from any inaccuracy or misprint of such information.
- 11) Please use the Products in accordance with any applicable environmental laws and regulations, such as the RoHS Directive. For more details, including RoHS compatibility, please contact a ROHM sales office. ROHM shall have no responsibility for any damages or losses resulting from non-compliance with any applicable laws or regulations.
- 12) When providing our Products and technologies contained in this document to other countries, you must abide by the procedures and provisions stipulated in all applicable export laws and regulations, including without limitation the US Export Administration Regulations and the Foreign Exchange and Foreign Trade Act.
- 13) This document, in part or in whole, may not be reprinted or reproduced without prior consent of ROHM.



Thank you for your accessing to ROHM product informations.
More detail product informations and catalogs are available, please contact us.

ROHM Customer Support System

<http://www.rohm.com/contact/>

General Precaution

1. Before you use our Products, you are requested to carefully read this document and fully understand its contents. ROHM shall not be in any way responsible or liable for failure, malfunction or accident arising from the use of any ROHM's Products against warning, caution or note contained in this document.
2. All information contained in this document is current as of the issuing date and subject to change without any prior notice. Before purchasing or using ROHM's Products, please confirm the latest information with a ROHM sales representative.
3. The information contained in this document is provided on an "as is" basis and ROHM does not warrant that all information contained in this document is accurate and/or error-free. ROHM shall not be in any way responsible or liable for any damages, expenses or losses incurred by you or third parties resulting from inaccuracy or errors of or concerning such information.

单击下面可查看定价，库存，交付和生命周期等信息

[>>ROHM Semiconductor \(罗姆\)](#)