



---

HS-100B

# Demo Board User Manual

Version: 1.0

## NOTICES

THIS DOCUMENT IS PROVIDED "AS IS" WITH NO WARRANTIES WHATSOEVER, INCLUDING ANY WARRANTY OF MERCHANTABILITY, NONINFRINGEMENT, FITNESS FOR ANY PARTICULAR PURPOSE, OR ANY WARRANTY OTHERWISE ARISING OUT OF ANY PROPOSAL, DOCUMENT OR SAMPLE.

ALL RIGHTS RESERVED. NO PART OF THIS DOCUMENT MAY BE REPRODUCED OR TRANSMITTED IN ANY FORM OR BY ANY MEANS, ELECTRONIC OR MECHANICAL, INCLUDING INFORMATION STORAGE AND RETRIEVAL SYSTEMS, WITHOUT PERMISSION IN WRITING FROM THE C-MEDIA ELECTRONICS, INC.

## COPYRIGHT

**Copyright© 2010-2013 C-Media Electronics Inc.**

All rights reserved. All content included on this document, such as text, graphics, logos, button icons, images, audio clips, digital downloads, data compilations, and software, is either the exclusive property of C-Media Electronics Inc., its affiliates (collectively, "C-Media"), its content suppliers, or its licensors and protected by Republic of China and international copyright laws.

## TRADEMARKS

C-Media, the C-Media Logo, Xear 3D, Xear 3D Logo, Speaker Shifter, Smart Jack, and Smart Audio Jack, Middleware are trademarks of C-Media Electronics Inc. in Republic of China and/or other countries. All other brand and product names listed are trademarks or registered trademarks of their respective holders and are hereby recognized as such.

\*C-Media reserves the right to modify the specifications without further notice\*

### **Cmedia Electronics, Inc.**

6F, 100, Sec. 4, Civil Boulevard, Taipei, Taiwan 106, R.O.C.

TEL: 886-2-8773-1100      FAX: 886-2-8773-2211

<http://www.Cmedia.com.tw>

For detailed product information, please contact [sales@cmedia.com.tw](mailto:sales@cmedia.com.tw)

## Revision Notes

Revision	Date	Description
1.0	2013/09/23	First formal release

## TABLE OF CONTENTS

### SECTION 1 OVERVIEW

1.1 Introduction to HS-100B.....	5
1.2 Take a close look at HS-100B Demo Board.....	6

### SECTION 2 GETTING STARTED

2.1 Board as USB Audio Device.....	7
2.2 Playback / Recording Functions.....	8
2.3 Evaluation Board with Peripheral Control.....	9

## SECTION 1 OVERVIEW

### 1.1 Introduction

Cmedia's HS-100B is highly-integrated USB audio single chip optimized for consumer headset solutions. This document is a user guide for the demonstration boards (demo boards) of HS-100B, which describes the board's functions, I/O jacks, LEDs, controls and some user notes.

HS-100B supports standard HID compliant volume control pins and playback mute/recording mute, and it also offers playback operation and playback/record mute LED indicators in order that users know the current status.

All necessary analog and digital modules are embedded in HS-100B, including stereo DAC, headphone driver, Mono ADC, microphone pre-amp booster, PLL, regulator, and USB transceiver.

In addition, internal cost effective embedded oscillator generates steady clock signal for the operating clock, so the system designers of the products can reduce the BOM cost by eliminating the crystal oscillator and the necessary circuit around it. End users will get good sound experience either on PC or on game console.

## 1.2 Evaluation Board Contents

The HS-100B controller demonstration board has several hardware features. With each feature's description in Figure 1, the feature's location can be clearly identified.

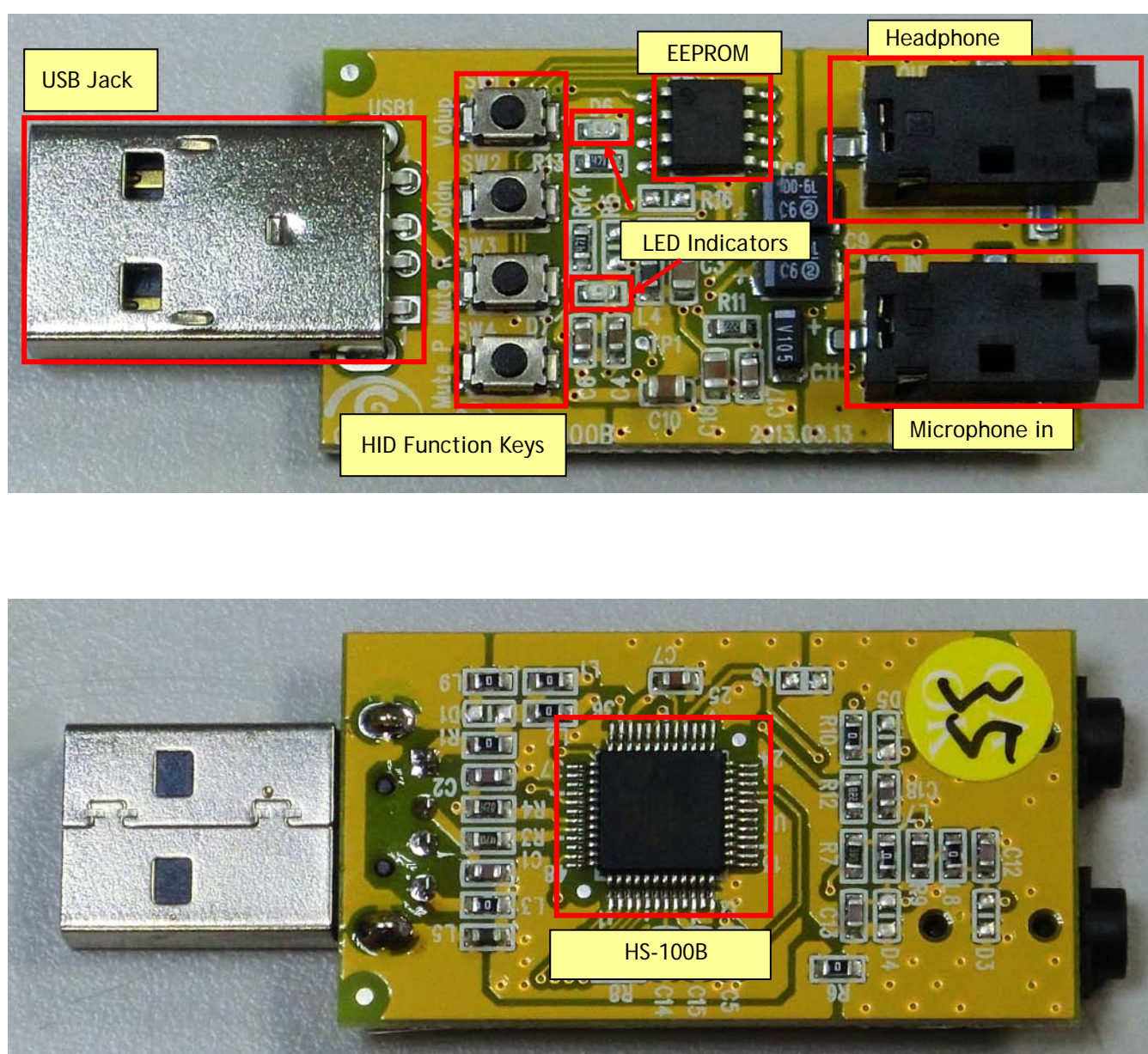

Figure 1

## SECTION 2 GETTING STARTED

### 2.1 Board as USB Audio Device

1. Connect the demo board to the host PC by plugging the USB Jack into host's USB port, as shown in Figure 2

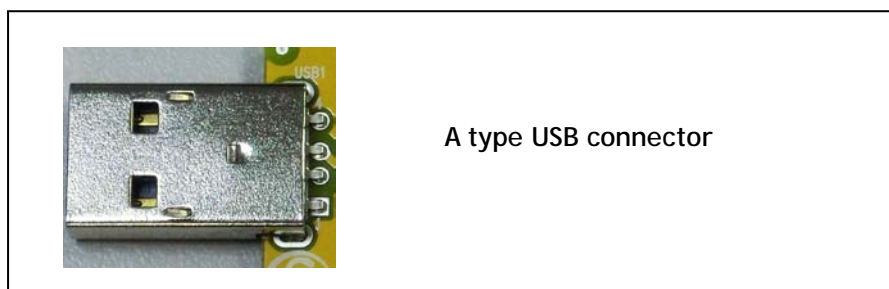

Figure 2 USB connector

2. Check LED "STATUS" for power-on and current status, as shown in Figure 3.  
When the device is connected, the STATUS LED lights still, and when playing/recording, the STATUS flashes.

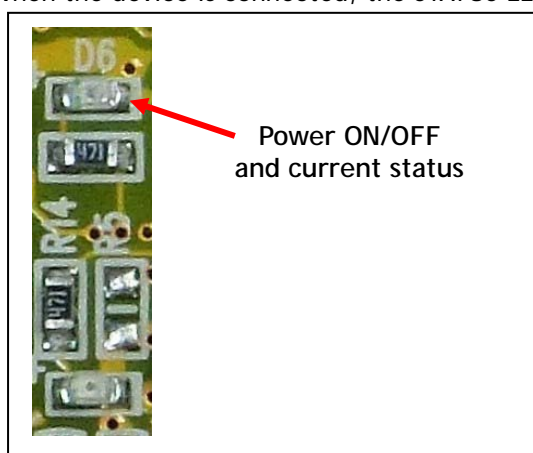

Figure 3 LED indicators

## 2.2 Playback / Recording Functions

### 2.2.1 Playback Functions

HS-100B's playback function includes dual DAC and an earphone driver. The capabilities of playback are listed below.

Device	Audio Out Capability
HS-100B Analog Output	Stereo (2 channel) 48KHz/44.1KHz sampling rates with 16bit Resolution

#### Headphone Output



Figure 4 Headphone out jack

### 2.2.2 Recording Functions

HS-100B's recording function supports single channel multiple sampling rates with 16-bit resolution. The capabilities of recording are listed below.

	Audio In Capability
HS-100B Analog Input	Mono 48KHz /44.1KHz sampling rates with 16bit resolution

#### Microphone Input

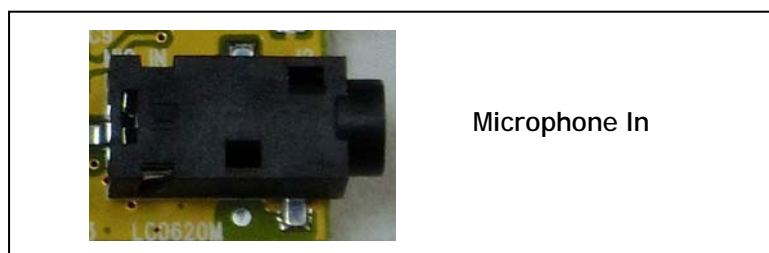

Figure 9 Microphone input jack



## 2.3 Evaluation Board with peripheral Control

HS-100B embedded external peripheral control and IO pins.

- EEPROM Interface
- HID Buttons
- LED Indicators

### 2.3.1 EEPROM Interface

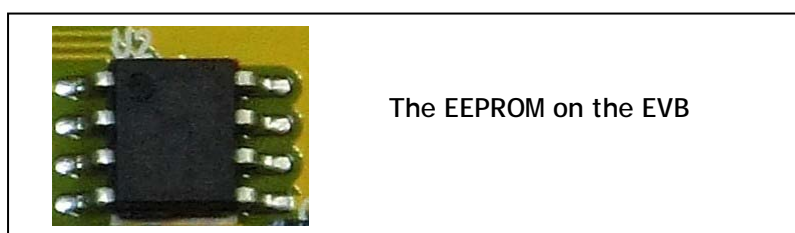
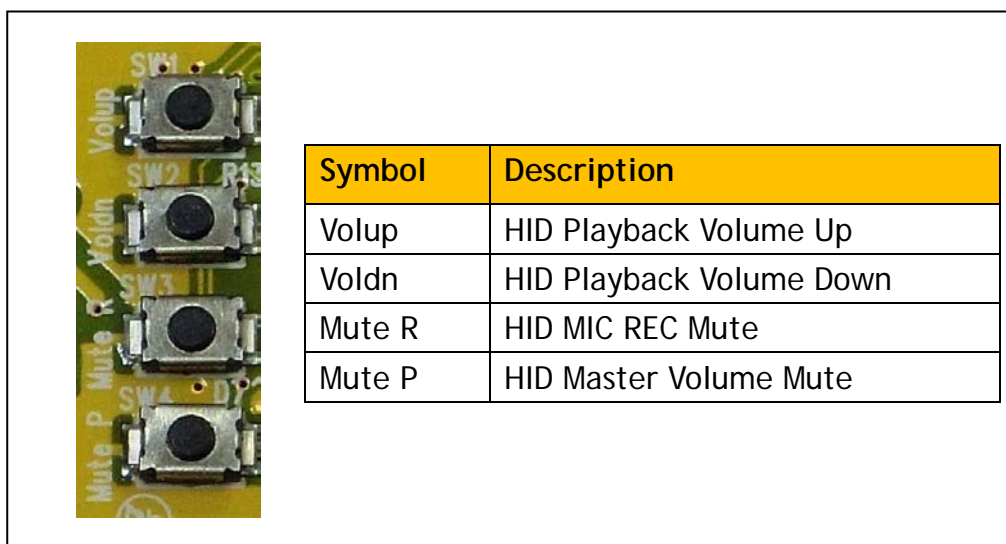
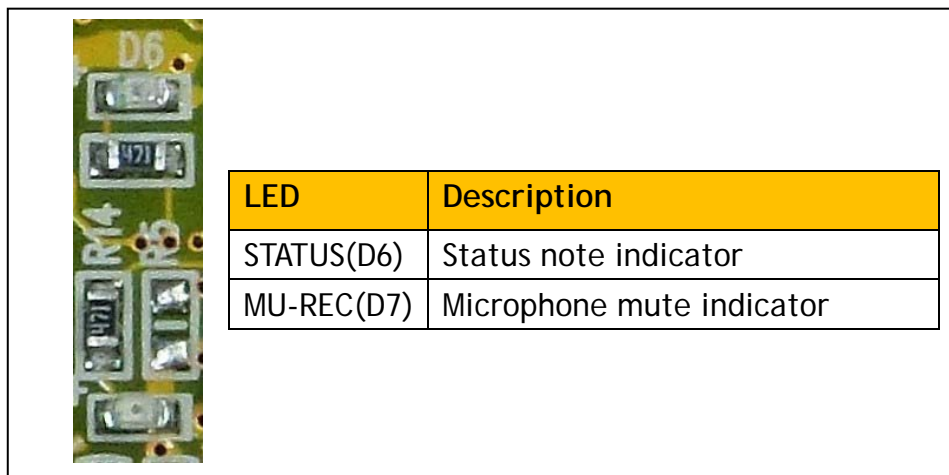

Figure 10 EEPROM Interface

### 2.3.2 HID Buttons



### 2.3.3 LED Indicators



Status Indicator LED: When device is powered and enumerated by the host, the LED lights still. When playback or recording is operating, LED flashes. When both playback and recording are operating, LED flashes fast.

MU-REC LED: When recording is mute, the LED lights still.

单击下面可查看定价，库存，交付和生命周期等信息

[>>Cmedia\(驛讯\)](#)