

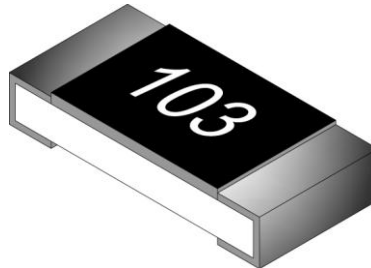

# CR-Series Thick Film Chip Resistor Product Specifications

Document No.	S-10-12-01-06
Released Date	2019/08/22
Page No.	0/11

## Thick Film Chip Resistor — CR Series



### Application

- Entertainment: Stereo, TV tuners, Tape recorder
- Appliance: Air conditioner, Refrigerator
- Computer & relative products: Main board, PDA
- Communication equipment: Cell phone, Fax machine
- Power equipment: Power supply, Illumination equipment
- Measuring instrument: Electric meter, Navigation equipment

### Features

- Small size and light weight
- Reduction of assembly costs and matching with placement machines
- Reliability, high quality and fast delivery

## Parts Number Explanation

Example:

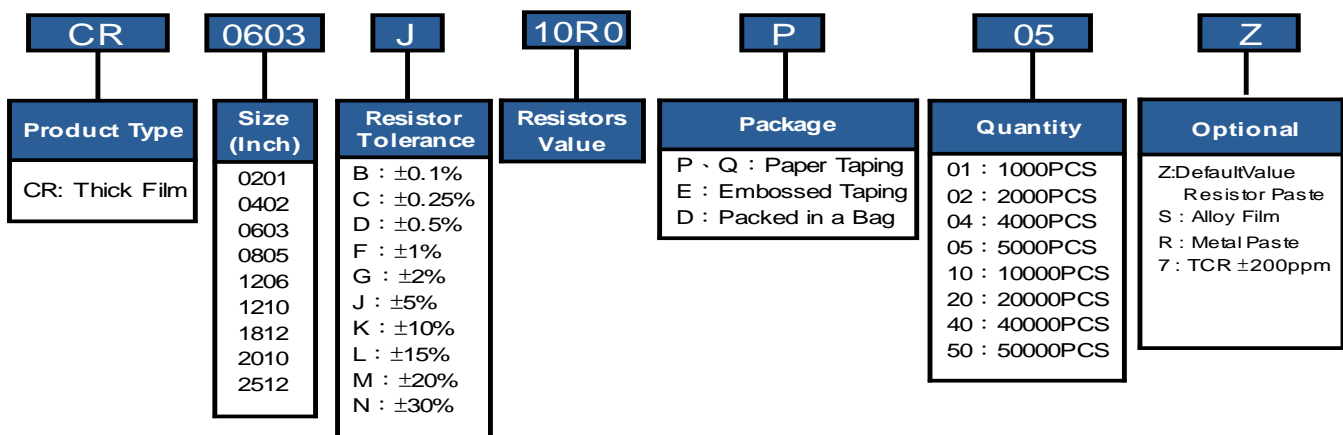



## CR-Series Thick Film Chip Resistor Product Specifications

Document No.	S-10-12-01-06
Released Date	2019/08/22
Page No.	1/11

### ■ Standard Electrical Specifications

Type	Item	Rated Power at 70℃	Max Working Voltage	Max Overload Voltage	T.C.R. (PPM/℃)	Resistance Range		
						B(±0.1%) D(±0.5%)	F(±1%) G(±2%)	J(±5%)
CR0201		0.05 W	25V	50V	-200/+400	-	1Ω ≤ R < 10Ω	
					±200	-	10Ω ≤ R ≤ 10MΩ	
CR0402		0.063 W	50V	100V	±400	-	1Ω ≤ R < 10Ω	
					±100	10Ω ≤ R ≤ 1MΩ	10Ω ≤ R ≤ 10MΩ	
CR0603		0.1 W	75V	150V	±400	-	1Ω ≤ R < 10Ω	
					±100	10Ω ≤ R ≤ 1MΩ	10Ω ≤ R ≤ 10MΩ	
CR0805		0.125 W	150V	300V	±400	-	1Ω ≤ R < 10Ω	
					±100	10Ω ≤ R ≤ 1MΩ	10Ω ≤ R ≤ 10MΩ	
CR1206		0.25 W	200V	400V	±400	-	1Ω ≤ R < 10Ω	
					±100	10Ω ≤ R ≤ 1MΩ	10Ω ≤ R ≤ 10MΩ	
CR1210		0.5 W	200V	400V	±400	-	1Ω ≤ R ≤ 10Ω	
					±100	10Ω ≤ R ≤ 1MΩ	10Ω < R ≤ 10MΩ	
CR1812		0.75 W	200V	400V	±400	-	1Ω ≤ R ≤ 10Ω	
					±100	10Ω ≤ R ≤ 1MΩ	10Ω < R ≤ 10MΩ	
CR2010		0.75 W	200V	400V	±400	-	1Ω ≤ R ≤ 10Ω	
					±100	10Ω ≤ R ≤ 1MΩ	10Ω < R ≤ 10MΩ	
CR2512		1 W	200V	400V	±400	-	1Ω ≤ R ≤ 10Ω	
					±100	10Ω ≤ R ≤ 1MΩ	10Ω < R ≤ 10MΩ	

- For non-standard parts, please contact our sales dept.
- Operating Temperature Range : -55℃ ~ +155℃
- Type CR1210/1812/2010/2512 1Ω ≤ R ≤ 10Ω optional code 「S」 is Alloy Film
- Type CR0402/0603/0805/1206 1Ω ≤ R < 10Ω optional code 「7」 is TCR: ±200PPM
- Type CR1210/1812/2010/2512 1Ω ≤ R ≤ 10Ω optional code 「7」 is TCR: ±200PPM

Type	0201	0402	0603	0805	1206	1210	1812	2010	2512
Jumper Resistance Value	50mΩ Max								
Jumper Rated Current	0.5A	1A			2A				



## CR-Series Thick Film Chip Resistor Product Specifications

Document No.	S-10-12-01-06
Released Date	2019/08/22
Page No.	2/11

### ● Low Ohm Chip Resistor ■ Standard Electrical Specifications

Item Type	Rated Power at 70 °C	Rated Voltage Range	Max Overload Voltage	T.C.R. (PPM/ °C)	Resistance Range (mΩ)
					F(±1%)、J(±5%)
CR0402	0.063 W	0.12~0.25V	0.624 V	±1000	220 ≤ R ≤ 450
				±800	450 < R < 1000
CR0603	0.1 W	0.09~0.31V	0.775 V	±1000	75 ≤ R < 100
				±800	100 ≤ R ≤ 330
				±600	330 < R < 1000
CR0805	0.125 W	0.04~0.35V	0.875 V	±1800	10 ≤ R < 50
				±800	50 ≤ R < 100
				±600	100 ≤ R < 1000
CR1206	0.25 W	0.05~0.5V	1.25 V	±1800	10 ≤ R < 50
				±800	50 ≤ R < 100
				±600	100 ≤ R < 1000
CR1210	0.5 W	0.07~0.7V	1.75 V	±1800	10 ≤ R < 50
				±800	50 ≤ R < 100
				±600	100 ≤ R < 1000
CR1812	0.75 W	0.08~0.8V	2.15 V	±1800	10 ≤ R < 50
				±800	50 ≤ R < 100
				±600	100 ≤ R < 1000
CR2010	0.75 W	0.08~0.8V	2.15 V	±1800	10 ≤ R < 50
				±800	50 ≤ R < 100
				±600	100 ≤ R < 1000
CR2512	1 W	0.1~0.99V	2.475V	±1800	10 ≤ R < 50
				±800	50 ≤ R < 100
				±600	100 ≤ R < 1000

- For non-standard parts, please contact our sales dept.
- Operating Temperature Range : -55°C ~ +155°C.
- Type CR1206/1210/1812/2010/2512 50 mΩ ~ 990mΩ optional code 「R」 is Metal Paste.



# CR-Series Thick Film Chip Resistor Product Specifications

Document No.	S-10-12-01-06
Released Date	2019/08/22
Page No.	3/11

## ● High Ohm Chip Resistor

### ■ Standard Electrical Specifications

Item Type	Rated Power at 70°C	Max Working Voltage	Max Overload Voltage	T.C.R. (PPM/ °C)	Resistance Range	
					F(±1%)	J(±5%)
CR0402	0.063 W	50V	100V	±200	10.1 MΩ ~ 30 MΩ	10.1 MΩ ~ 30 MΩ
CR0603	0.1 W	75V	150V			
CR0805	0.125 W	150V	300V			
CR1206	0.25 W	200V	400V			
CR1210	0.5 W					
CR2010	0.75 W					
CR2512	1 W					

- For non-standard parts, please contact our sales dept.
- Operating Temperature Range : -55°C ~ +155°C.

### ■ Type Dimension

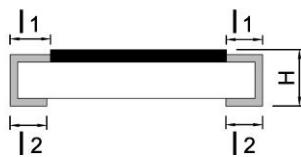
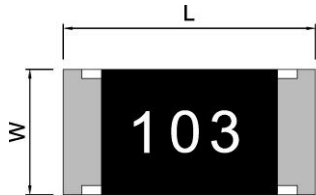

CR0201 / CR0402 / CR0603 / CR0805 / CR1206  
CR1210 / CR1812 / CR2010 / CR2512

TYPE	L	W	H	L <sub>1</sub>	L <sub>2</sub>
CR0201	0.60 ± 0.03	0.30 ± 0.03	0.23 ± 0.05	0.15 ± 0.05	0.15 ± 0.05
CR0402	1.00 ± 0.10	0.50 ± 0.05	0.30 ± 0.05	0.15 ± 0.10	0.20 ± 0.10
CR0603	1.60 ± 0.20	0.80 ± 0.15	0.40 ± 0.10	0.30 ± 0.20	0.30 ± 0.10
CR0805	2.00 ± 0.20	1.25 ± 0.15	0.50 ± 0.15	0.30 ± 0.15	0.40 ± 0.15
CR1206	3.05 ± 0.10	1.60 ± 0.20	0.55 ± 0.15	0.40 ± 0.20	0.50 ± 0.20
CR1210	3.05 ± 0.10	2.50 ± 0.20	0.55 ± 0.15	0.50 ± 0.20	0.50 ± 0.20
CR1812	4.50 ± 0.10	3.10 ± 0.20	0.55 ± 0.05	0.55 ± 0.20	0.70 ± 0.20
CR2010	5.00 ± 0.20	2.50 ± 0.20	0.55 ± 0.10	0.60 ± 0.20	0.60 ± 0.20
CR1218	3.10 ± 0.10	4.60 ± 0.10	0.55 ± 0.05	0.40 ± 0.20	0.50 ± 0.20
CR2512	6.30 ± 0.20	3.20 ± 0.20	0.55 ± 0.10	0.60 ± 0.20	0.60 ± 0.20

● **General Information**

■ **Recommend Land Pattern Design**

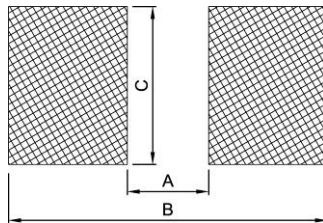

■ **Dimension**

Unit:mm

Type	0201	0402	0603	0805	1206	1210	1812	2010	2512
A	0.25	0.60	0.80	1.30	2.20	2.00	3.11	3.80	4.90
B	1.10	1.60	2.40	2.90	4.20	4.40	5.91	6.60	8.10
C	0.32	0.70	1.00	1.40	1.70	2.70	3.00	2.70	3.40

■ **Performance Characteristics**

■ **Power Derating Curve**

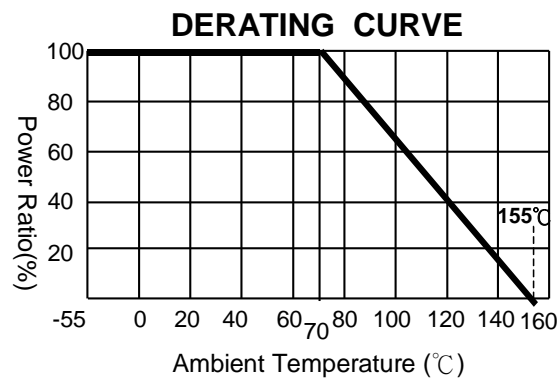

Power rating or current rating is in the case based on continuous full-load at ambient temperature of 70°C. For operation at ambient temperature in excess of 70°C, the load should be derated in accordance with figure of derating Curve.

■ **Voltage Rating or Current Rating**

Resistance Range:  $\geq 1 \Omega$

Rated Voltage: The resistor shall have a DC continuous working voltage or a RMS AC continuous working voltage at commercial-line frequency and wave form corresponding to the power rating, as determined formula as following:

$$E(RCWV) = \sqrt{P \times R}$$

E=Rated voltage(V)  
 P=Power rating(W)  
 R=Nominal resistance( $\Omega$ )



# CR-Series Thick Film Chip Resistor Product Specifications

Document No. S-10-12-01-06  
Released Date 2019/08/22  
Page No. 5/11

## ● Reliability Test and Requirement

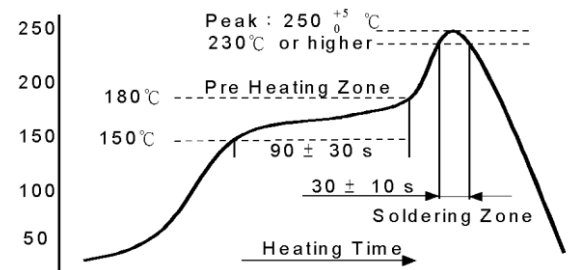
Test Item	Test Method	Procedure	Requirements
Temperature Coefficient of Resistance (T.C.R)	JIS C 5201-1 clause 4.8	-55°C or +155°C, 25°C is the reference temperature	Refer to Ratings
Short Time Overload	JIS C 5201-1 clause 4.13	General : 2.5 times RCWV or Max. Overload voltage whichever is less for 5 seconds.	1% : ±(1.0%+0.05 Ω) 5% : ±(2.0%+0.10 Ω)
IR Reflow	Sony SS-00254	 <p>The graph shows a temperature profile for IR reflow. The y-axis is temperature in °C (50 to 250) and the x-axis is Heating Time. Key points include: a peak of 250 ± 5 °C (230 °C or higher), a pre-heating zone at 180 °C, and a soldering zone at 150 °C. Time intervals are marked as 90 ± 30 s for pre-heating and 30 ± 10 s for soldering.</p>	1% : ±(1.0%+0.05 Ω) 5% : ±(1.0%+0.05 Ω)
Leaching	Sony SS-00254-9	260±5°C for 30 seconds.	>95% Coverage
Soldering Heat	JIS C 5201-1 clause 4.18	260±5°C for 10 seconds.	1% : ±(0.5%+0.05 Ω) 5% : ±(1.0%+0.05 Ω)
Temperature Cycling	JIS C 5201-1 clause 4.19	-55°C to +155°C, 5 cycles	0.1%、0.5%、1% : ±(0.5%+0.05 Ω) 2%、5% : ±(1.0%+0.10 Ω)
Electric Iron	Sony SS-00254-5	Preheating temperature : 350±10°C Electric iron preheating time : 3+1/-0 sec	1% : ±(1.0%+0.05 Ω) 5% : ±(1.0%+0.05 Ω)
Resistance to Solvent	JIS C 5201-1 clause 4.29	The tested resistor be immersed into isopropyl alcohol of 20~25°C for 60 secs. Then the resistor is left in the room for 48 hrs.	1% : ±(0.5%+0.05 Ω) 5% : ±(0.5%+0.05 Ω)
Load Life in Humidity	JIS C 5201-1 clause 4.24	40±2°C, 90~95% R.H. RCWV or Max. working voltage whichever is less for 1000 hrs with 1.5 hrs "ON" and 0.5 hr "OFF" .	0.1%、0.5%、1% : ±(1.0%+0.05 Ω) 2%、5% : ±(2.0%+0.05 Ω) Value <1Ω : ±(2.0%+0.05 Ω)
Load Life (Endurance)	JIS C 5201-1 clause 4.25	70±2°C, RCWV or Max. working voltage whichever is less for 1000 hrs with 1.5 hrs "ON" and 0.5 hr "OFF" .	0.1%、0.5%、1% : ±(1.0%+0.05 Ω) 2%、5% : ±(3.0%+0.10 Ω) Value <1Ω : ±(3.0%+0.10 Ω)
Insulation Resistance	JIS C 5201-1 clause 4.6	100V for 1 minute.	≥ 10G Ω
Terminal Bending Strength	JIS C 5201-1 clause 4.33	Bending once for 5 seconds D : 0402、0603、0805=5mm 1206、1210、1812=3mm 1218、2010、2512、2030=2mm	1% : ±(1.0%+0.05 Ω) 5% : ±(1.0%+0.05 Ω)



# CR-Series Thick Film Chip Resistor Product Specifications

Document No.	S-10-12-01-06
Released Date	2019/08/22
Page No.	6/11

## Appendix For SMD Chip Resistor

### ● Packaging Information

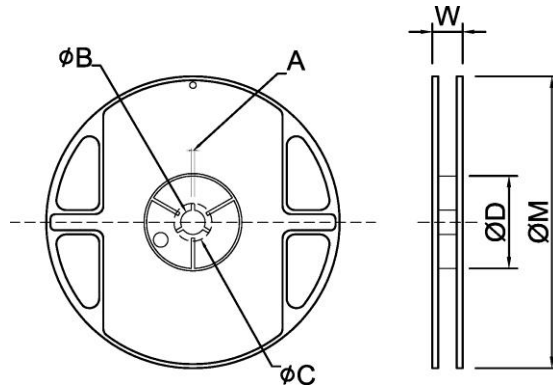

### Dimension

Unit:mm

TYPE	SIZE		A	$\phi B$	$\phi C$	$\phi D$	W	$\phi M$
0201/0402	7"	10K/Reel	2.0±0.5	13.5±1.0	21±1.0	60±1.0	11.5±2.0	178±2.0
0402	13"	40K/50K Reel	2.0±0.5	13.5±1.0	21±1.0	100±1.0	11.5±2.0	330±2.0
0603/0805/1206/ 1210	7"	5K/Reel	2.0±0.5	13.5±1.0	21±1.0	60±1.0	11.5±2.0	178±2.0
0603/0805 /1206	10"	10K/Reel	2.0±0.5	13.5±1.0	21±1.0	100±1.0	11.5±2.0	254±2.0
	13"	20K/Reel	2.0±0.5	13.5±1.0	21±1.0	100±1.0	11.5±2.0	330±2.0
2010/2512/1812	7"	4K/Reel	2.0±0.5	13.5±1.0	21±1.0	60±1.0	16.0±2.0	178±2.0

### ■ Tapping Specification

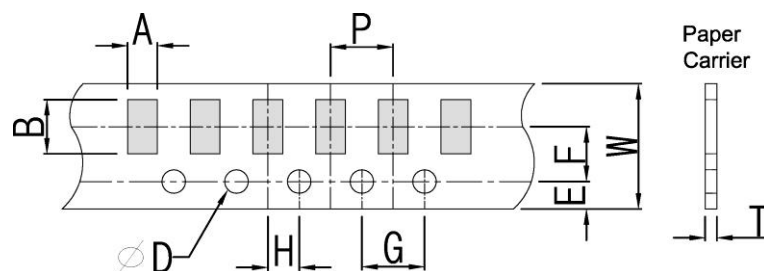



# CR-Series Thick Film Chip Resistor Product Specifications

Document No. S-10-12-01-06

Released Date 2019/08/22

Page No. 7/11

## Dimension

Unit:mm

Packaging	Type	A	B	W	E	F	G	H	T	$\phi D$	P
Paper Type	0201	0.45±0.1	0.75±0.1	8.0±0.2	1.75±0.1	3.5±0.05	4.0±0.1	2.0±0.05	0.35±0.1	1.50 <sup>+0.10</sup>	2.0±0.1
	0402	0.70±0.1	1.20±0.1	8.0±0.2	1.75±0.1	3.5±0.05	4.0±0.1	2.0±0.05	0.45±0.1		1.50 <sup>-0</sup>
	0603	1.05±0.2	1.80±0.2	8.0±0.2	1.75±0.1	3.5±0.05	4.0±0.1	2.0±0.05	0.60±0.1		
	0805	1.55±0.2	2.30±0.2	8.0±0.2	1.75±0.1	3.5±0.05	4.0±0.1	2.0±0.05	0.75±0.1		
	1206	1.90±0.2	3.50±0.2	8.0±0.2	1.75±0.1	3.5±0.05	4.0±0.1	2.0±0.05	0.75±0.1		
1210	2.85±0.2	3.50±0.2	8.0±0.2	1.75±0.1	3.5±0.05	4.0±0.1	2.0±0.05	0.75±0.1			

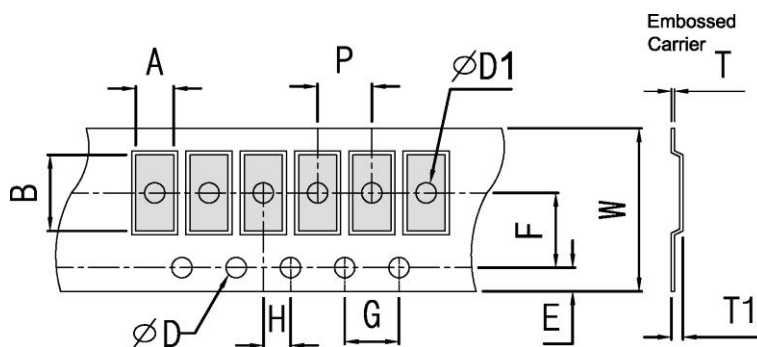

## Dimension

Unit: mm

Packaging	Type	A	B	W	E	F	G	H	T	$\phi D$	$\psi D1$	T1	P
Embossed Type	2010	2.80±0.20	5.60±0.20	12±0.10	1.75±0.10	5.5±0.05	4.0±0.10	2.0±0.05	0.23±0.10	1.50 <sup>+0.10</sup>	1.50±0.10	0.85±0.15	4.0±0.1
	2512	3.40±0.20	6.70±0.20	12±0.10	1.75±0.10	5.5±0.05	4.0±0.10	2.0±0.05	0.23±0.10		1.50 <sup>-0</sup>	1.50±0.10	
	1812	3.30±0.20	4.60±0.20	12±0.10	1.75±0.10	5.5±0.05	4.0±0.10	2.0±0.05	0.23±0.10	1.50±0.10		0.85±0.15	

## Packing Material Data/Storage Data

### Front & Back Lead Dimension

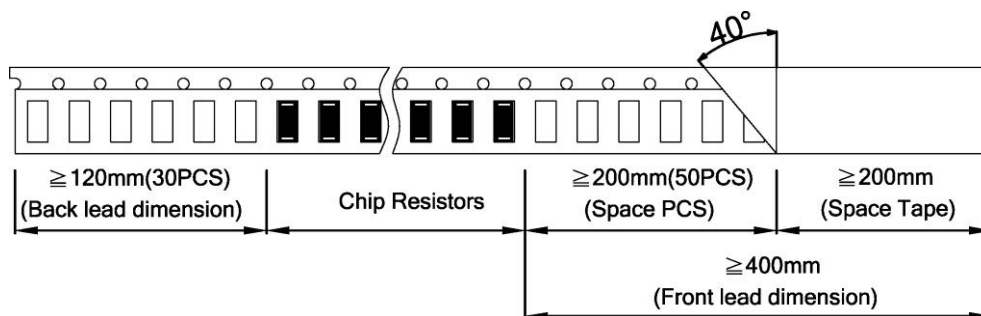





## CR-Series Thick Film Chip Resistor Product Specifications

Document No.	S-10-12-01-06
Released Date	2019/08/22
Page No.	8/11

### ■ Top Adhesive Peel Off Strength : 10~70g

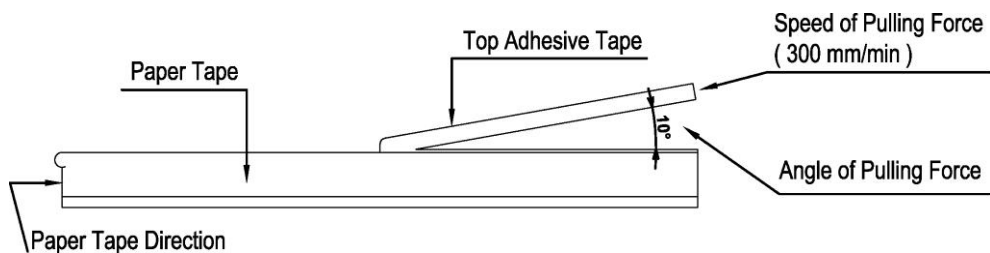

### ■ Package

Inner Box Size	
Reel	Size H(mm)
1	13
2	24
3	36
5	60
10	113

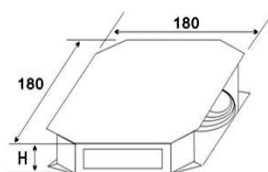

External Box Size			
Contain (Kpcs)	Length (mm)	Width (mm)	Height (mm)
25K	180	180	60
50K	180	180	110
150K	430	200	200
300K	400	400	200

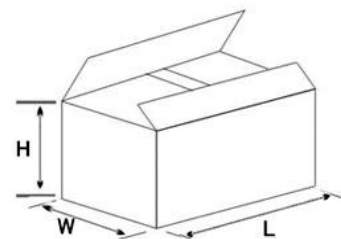

### ■ Storage Data :

Storage time at the environment temp:  $25\pm 5^{\circ}\text{C}$  & humidity:  $60\pm 20\%$  is valid for one year from the date of delivery.



# CR-Series Thick Film Chip Resistor Product Specifications

Document No.	S-10-12-01-06
Released Date	2019/08/22
Page No.	9/11

## ■ Equipments Applicable:

Our company's products are produced under low temperature processing applicable to IR reflow surface mounting devices. It is comparatively not applicable to wave soldering which will possibly cause the risk ablating the element protection layer and the front conductor and cause the drift of the resistance value and ablation of the markings.

## ■ Product Testing Method:

Our products are tested with our company's tapping & testing equipments by using four-foot probe to touch at the back of both electrodes. Supposed different testing points or methods are requested, please advise beforehand and customized-made production is available.

## ■ 0603 E-96 Multiplier Code

Code	A	B	C	D	E	F	G	H	X	Y	Z
Multiplier	10 <sup>0</sup>	10 <sup>1</sup>	10 <sup>2</sup>	10 <sup>3</sup>	10 <sup>4</sup>	10 <sup>5</sup>	10 <sup>6</sup>	10 <sup>7</sup>	10 <sup>-1</sup>	10 <sup>-2</sup>	10 <sup>-3</sup>

CODING FORMULA

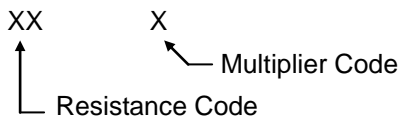

Example:  $10.2\text{K}\Omega = \frac{102}{02} \times \frac{10^2}{C}\Omega = 02\text{C}$   
 $33.2\Omega = \frac{332}{51} \times \frac{10^{-1}}{X}\Omega = 51\text{X}$

## ■ 0603 Standard E-96 Values and 0603 Resistance Codes

R-Value	100	102	105	107	110	113	115	118	121	124	127	130	133	137	140	143	147	150	154	158	162	165	169	174
Code	01	02	03	04	05	06	07	08	09	10	11	12	13	14	15	16	17	18	19	20	21	22	23	24
R-Value	178	182	187	191	196	200	205	210	215	221	226	232	237	243	249	255	261	267	274	280	287	294	301	309
Code	25	26	27	28	29	30	31	32	33	34	35	36	37	38	39	40	41	42	43	44	45	46	47	48
R-Value	316	324	332	340	348	357	365	374	383	392	402	412	422	432	442	453	464	475	487	499	511	523	536	549
Code	49	50	51	52	53	54	55	56	57	58	59	60	61	62	63	64	65	66	67	68	69	70	71	72
R-Value	562	576	590	604	619	634	649	665	681	698	715	732	750	768	787	806	825	845	866	887	909	931	953	976
Code	73	74	75	76	77	78	79	80	81	82	83	84	85	86	87	88	89	90	91	92	93	94	95	96



## CR-Series Thick Film Chip Resistor Product Specifications

Document No.	S-10-12-01-06
Released Date	2019/08/22
Page No.	10/11

### ■ Standard Resistance Values in a Decade

Marking code:

- 1%: marking code, please refer to E96 and E24 data form as below  
 Ex: 120K, The marking code is 1203 in E24  
 121K, The marking code is 1213 in E96
- 5%: marking code, please refer to E24 data form as below  
 Ex: 120K, The marking code is 124 in E24
- Note: 0402 series resistor has no marking code.
- Type: 0603 1% marking code, please refer to E-96 multiplier code.
- Note: jumper zero ohm resistor marking code is one 「0」 (except type below 0402).

E192	E96	E48	E192	E96	E48	E192	E96	E48	E192	E96	E48	E192	E96	E48	
100	100	100	169	169	169	287	287	287	487	487	487	825	825	825	
101			172			291			493			835			
102	102		174	174		294	294		499	499		845	845		
104			176			298			505			856			
105	105	105	178	178	178	301	301	301	511	511	511	866	866	866	
106			180			305			517			876			
107	107		182	182		309	309		523	523		887	887		
109			184			312			530			898			
110	110	110	187	187	187	316	316	316	536	536	536	909	909	909	
111			189			320			542			920			
113	113		191	191		324	324		549	549		931	931		
114			193			328			556			942			
115	115	115	196	196	196	332	332	332	562	562	562	953	953	953	
117			198			336			569			965			
118	118		200	200		340	340		576	576		976	976		
120			203			344			583			988			
121	121	121	205	205	205	348	348	348	590	590	590				
123			208			352			597						
124	124		210	210		357	357		604	604		E24	E12	E6	E3
126			213			361			612			10	10	10	10
127	127	127	215	215	215	365	365	365	619	619	619	11			
129			218			370			626			12	12		
130	130		221	221		374	374		634	634		13			
132			223			379			642			15	15	15	
133	133	133	226	226	226	383	383	383	649	649	649	16			
135			229			388			657			18	18		
137	137		232	232		392	392		665	665		20			
138			234			397			673			22	22	22	22
140	140	140	237	237	237	402	402	402	681	681	681	24			
142			240			407			690			27	27		
143	143		243	243		412	412		698	698		30			
145			246			417			706			33	33	33	
147	147	147	249	249	249	422	422	422	715	715	715	36			
149			252			427			723			39	39		
150	150		255	255		432	432		732	732		43			
152			258			437			741			47	47	47	47
154	154	154	261	261	261	442	442	442	750	750	750	51			
156			264			448			759			56	56		
158	158		267	267		453	453		768	768		62			
160			271			459			777			68	68	68	
162	162	162	274	274	274	464	464	464	787	787	787	75			
164			277			470			796			82	82		
165	165		280	280		475	475		806	806		91			
167			284			481			816						

According to IEC publication 63

单击下面可查看定价，库存，交付和生命周期等信息

[>>天二](#)