

AUTOMOTIVE CURRENT TRANSDUCER FLUXGATE TECHNOLOGY

CAB 300-C/SP3-XXX



Introduction

The CAB family is for battery monitoring applications where high accuracy and very low offset are required.

Features

- Transducer using Fluxgate technology
- Zero offset
- Unlimited over-current capability
- Panel mounting
- Unipolar + 12 V battery power supply
- $T_A = -40\text{ °C} \dots +105\text{ °C}$
- Accuracy (over temperature range)
 - $\varepsilon_G =$ Sensitivity error < 0.5 %
 - $\varepsilon_L =$ Linearity error < 0.1 %
- Output signal:
 - CAN.C (500 kbps)
- Optional internal digital low-pass frequency filter.

Special feature

- Connector type Tyco AMP 1473672-1.

Advantages

- No offset error
- High accuracy
- Low linearity error
- Full galvanic separation.

Automotive applications

- Hybrid and electric vehicle battery pack
- Accurate current measurement for battery management applications (SOC, SOH, SOF etc.).

Principle of Fluxgate Transducers

A low-frequency fluxgate transducer is made of a wound core which saturates under low induction.

A current chopper switches the winding's current to saturate the magnetic core alternatively at $\pm B_{max}$ with a fixed frequency.

Fluxgate transducers use the change of the saturation's point symmetry to measure the primary current.

Due to the principle of switching the current, all offsets (electric and magnetic) are cancelled.

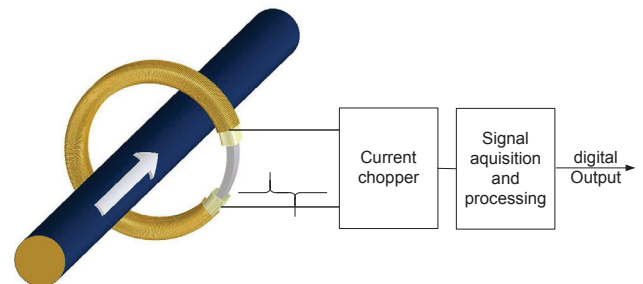

Dimensions CAB 300-C/SP3-XXX (in mm)

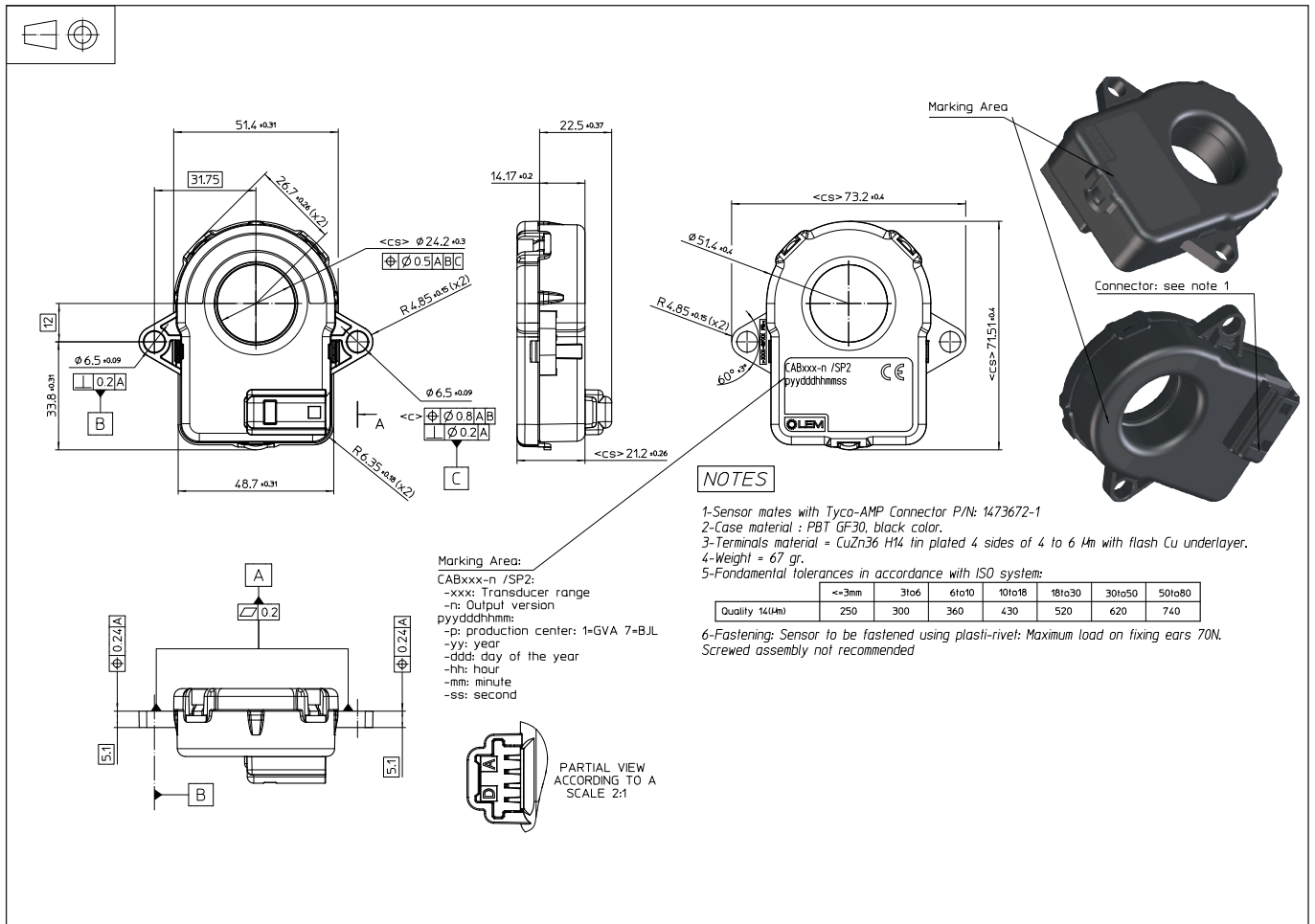

Mechanical characteristics

- Plastic case PBT GF 30
- Magnetic core Nanocrystalline
- Mass 67 g
- Electrical terminal coating Brass tin plated

Mounting recommendation

- Connector type Tyco-AMP P/N: 1 473672-1

Connection

Pin Out	
A	CAN-L
B	CAN-H
C	GND
D	U_c

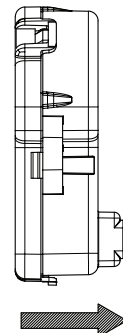
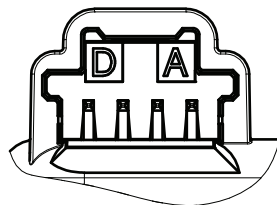

I_p (positive primary current direction)

CAB 300-C/SP3-XXX

Absolute ratings (not operating)

Parameter	Symbol	Unit	Specification	Conditions
Load dump over-voltage	U_C	V	32	400 ms
Over-voltage	U_C	V	24	1 minute
Reverse polarity	U_C	V	-50	
Minimum supply voltage	U_C	V	6	Continuous
Maximum supply voltage	U_C	V	18	Continuous
Electrostatic discharge voltage	U_{ESD}	KV	4	Pins
Insulation resistance	R_{IS}	MΩ	500	500 V-ISO 16750-2
Rms voltage for AC insulation test, 50 Hz, 1 min	U_d	KV	2.5	50 Hz, 1 min
Creepage distance	d_{CP}	mm	7.2	
Clearance	d_{CI}	mm	6.95	

Operating characteristics in nominal range (I_{PN})

Parameter	Symbol	Unit	Specification			Conditions
			Min	Typical	Max	
Electrical Data						
Primary current, measuring range	I_{PM}	A	-350		350	
Supply voltage	U_C	V	8	13.5	16	full accuracy
Current consumption @ $I_p = 0$ A	I_C	mA		25		@ $U_C = 13.5$ V @ 25 °C
Current consumption @ $I_p = 350$ A	I_C	mA		80		I_C is a function of I_p ; @ $U_C = 13.5$ V @ 25 °C
Performance Data						
Linearity error	ϵ_L	%	-0.1		0.1	in temperature range
Offset current @ $I_p = 0$ A ¹⁾	I_o	mA	-10		10	min/max values @ 3 sigma; 8 V to 16 V; from -40 °C to 85 °C
Overall accuracy @ $I_p = \pm 350$ A ¹⁾	X_G	mA	-1750		1750	min/max values @ 3 sigma; 8 V to 16 V; from -40 °C to 85 °C
Ambient operating temperature	T_A	°C	-40		105	

¹⁾ Average value of CAB output data over 100 ms.

CAB 300-C/SP3-XXX

Can Output

CAN Interface characteristics:

- CAN High Speed, SAE CAN Class C
- High speed CAN transceiver: TJA1040
- CAN protocol: Version 2.0A/B
- Byte order: big endian (Motorola)
- CAN oscillator tolerance: 0.27 %

Message Description	CAN ID	Name	Data Length (Nb bytes)	Type of frame	Message launch type	Signal Description	Signal Name	Start Bit	End Bit
Return Current I_p (mA)	See version table below	CAB300_ I_p	8	Standard	Cyclic tranced message 10ms cycle	I_p Value: 8000000H=0mA, 7FFFFFFFH=-1mA, 8000001H=1mA	IP_VALUE	0	31
						b0: Error Information (0=Normal, 1: failure)	ERROR_INDICATION	32	32
						b7 to b1: RxQuality (0 to 100%)	ERROR_INFORMATION	33	39
						Vacant bits (fixed to 0)	VACANT_DATA_3BYTES	40	63

Diagnostic Trouble Code (DTC)

FAILURE MODE	I_p VALUE	ERROR INDICATION	ERROR INFORMATION
Error on dataflash CRC	FFFF FFFF	1	0x41
Fluxgate running at high frequency (< 2.5 kHz) for more than 10 ms	FFFF FFFF	1	0x42
Fluxgate not oscillating for more than 20 ms	FFFF FFFF	1	0x43
CAB entered in fail safe mode	FFFF FFFF	1	0x44
Signal not available for more than 100 ms	FFFF FFFF	1	0x46
Supply voltage out of range	FFFF FFFF	1	0x47

Version table

PRODUCT NAME	PART NUMBER	CAN ID	CAN SPEED (kbps)
CAB 300-C/SP3-000	90.H5.46.003.0	0x3C0	500
CAB 300-C/SP3-001	90.H5.46.013.0	0x3C1	500
CAB 300-C/SP3-002	90.H5.46.023.0	0x3C2	500
CAB 300-C/SP3-003	90.H5.46.033.0	0x3C3	500
CAB 300-C/SP3-004	90.H5.46.043.0	0x3C4	500
CAB 300-C/SP3-005	90.H5.46.053.0	0x3C5	500
CAB 300-C/SP3-006	90.H5.46.063.0	0x3C6	500
CAB 300-C/SP3-007	90.H5.46.073.0	0x3C7	500
CAB 300-C/SP3-008	90.H5.46.083.0	0x3C8	500
CAB 300-C/SP3-009	90.H5.46.093.0	0x3C9	500
CAB 300-C/SP3-010	90.H5.46.103.0	0x3C2	250

CAB 300-C/SP3-XXX

Accuracy curves

I_c @ 25 °C at 13.5 V

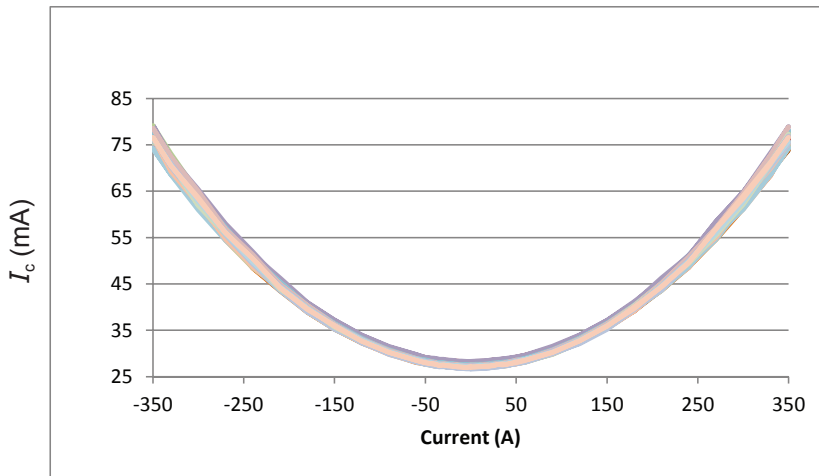

x_G over temperature range at ± 3 sigma

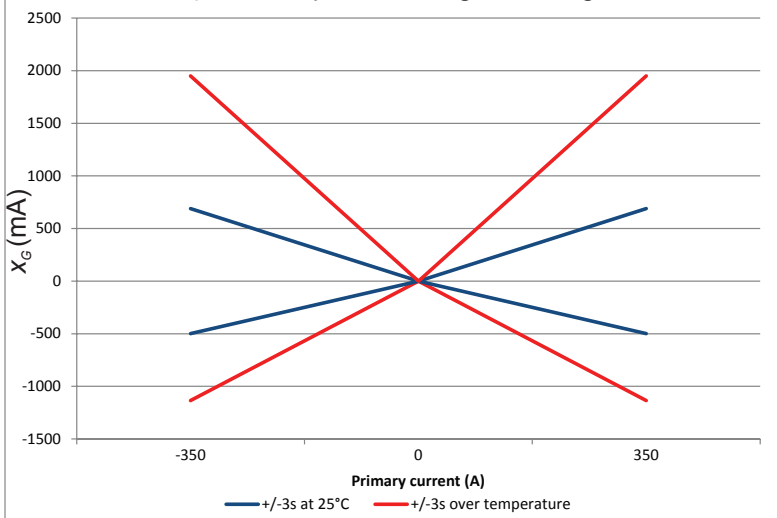

Statistic of Global error x_G at I_p ($U_c = 13.5$ V)

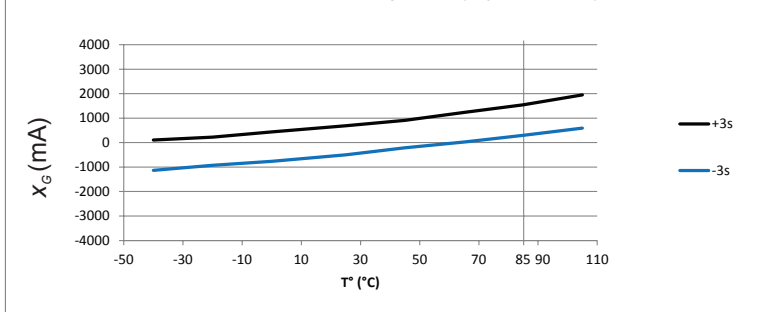

CAB 300-C/SP3-XXX

CAB Test table

Test	Test standard	Procédure
Environmental test		
Shipping/Storage Temperature Exposure	ISO 16750-4	164 hours, -40 °C/+85 °C, power off, slope 0.6 °C/min
Low Temperature Operating Endurance		120 hours, -40 °C, power on
High Temperature Operating Endurance		4752 hours, 85 °C, power on
Powered Thermal Cycle Endurance	ISO 16750-4	540 cycles/100 min: -40 °C (20 min), +85 °C (20 min), Slope 4 °C/min: 900 hours
Thermal Shock		-40 °C (20 min soak) / 85 °C (20 min soak), 1000 cycles, with connectors => 667 hours (28 days)
Thermal Humidity Cycle	IEC 60068-2-38	240 hours, -10 °C/+65 °C, 93 % humidity
High Temperature Operating Endurance	IEC 60068-2-67	85 °C, 85 % humidity, 1000 hours Performance after test: $I_o \leq 20 \text{ mA}$, $X_g \leq 3000 \text{ mA}$
Vibration		5 Hz to 1000 Hz (table 6-10), 20 hours / axis, 3 axis + -40 °C / +85 °C during 8 hours and 25 °C during 12 hours
Mechanical Shock	ISO 16750-3	500 m/s ² , 10 each direction (60 total) Half sine pulse
Package Drop		With final packaging 1m, 1 bottom, 4 bottom edges, 4 bottom corners => total 9 drops 1 meter on concrete floor.
Handling Drop	ISO 16750-3	1 fall in one direction for each sensor, from 1 meter on concrete floor
Dust (and other solid intrusion)	ISO 20653	IP category: 4
Water intrusion	ISO 20653	IP category: 1
Dew formation test	IEC 60068-2030	
Mixed Flowing Gas	IEC 60068-2-60	
Chemical exposure outside cabin	ISO 16750-5	24 hours / fluid; see PV test report for list of fluids

CAB 300-C/SP3-XXX

CAB Test table

EMC Test		
CISPR 25 Conducted RF Emissions-Voltage on	CISPR25	Narrow band: 0.15 to 108 MHz Wide band: 0.15 to 200 MHz
CISPR 25 Conducted RF Emissions-Current on all	CISPR25	Narrow band: 0.15 to 108 MHz Wide band: 0.15 to 200 MHz
CISPR 25 Radiated Emissions	CISPR25	30 to 1000 MHz
Bulk Current Injection (BCI) Test	ISO 11452-4	According to ISO 11452-4
ALSE with a Ground Plane	ISO 11452-2	According to ISO 11452-2
Transient Disturbances Conducted along Supply	ISO 7637-2	According to ISO 7637-2
Transient Disturbances Conducted along I/O	ISO 7637-3	According to ISO 7637-3
Handling Test	ISO 10605	Test method: IEC 61000-4-2 (2008) pins: ± 4 kV case: ± 8 kV
Operating Test	IEC 61000-4-2	Test method: IEC 61000-4-2 (2008) Indirect contact discharge: ± 8 kV Air discharge: ± 20 kV
Impulse Noisy Test		± 2 kV noise simulator, on each line
Fast Transient Noise Test		± 2 kV fast transient simulator, on each line
Electrical Test		
Supply Voltage Range		8 V to 16 V; from -40 °C to 105 °C
Supply Voltage Ripple	SAE J1113-2	According to SAE J1113-2
Supply Voltage Drop Out		Supply Voltage Drop from 11 V to 0 V and return to 11 V Drop duration increase from 10 μ s to 1 ms (sensor fonctionnal) and from 1 ms to 2 s (sensor not damaged)
Supply Voltage Dips		Supply voltage Dips from 11 V to dip voltage and return to 11 V Dips voltage are 5.5 V, 5 V, 4.5 V, 4 V, 3.5 V and 3 V Dips duration for each level are 100 μ s - 1 ms (sensor fonctionnal) and 1 ms - 500 ms (sensor not damaged)
Slow decreases and increase	ISO 16750-2 (2004)	According to ISO 16750-2
Defective regulation (full fielded alternator)		24 V, 1 minute
Jumps Start		18 V, 60 minutes, @ 65 °C
Load Dump		32 V, 400 ms; 5 pulses
Reverse Supply Voltage	ISO 16750-2 (2004)	-16 V, 1 minute

PERFORMANCES PARAMETERS DEFINITIONS

Linearity:

The maximum positive or negative discrepancy with a reference straight line I_p value = $f(I_p)$

Unit: linearity (%) expressed with full scale of I_{PN} .

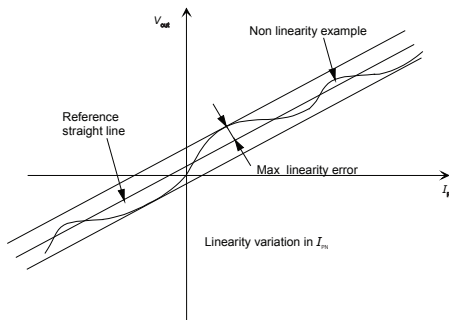

Accuracy:

Accuracy is the maximum error between measured value and a reference value.

Phase delay:

The phase delay is the maximum time difference between CAN frame sending and internal sampling of primary current.

单击下面可查看定价，库存，交付和生命周期等信息

[>>LEM\(莱姆\)](#)