

**High sensitivity, 100 mW  
Nominal operating power,  
2 Form C and 1 A  
Slim body type relays**

## GN RELAYS (AGN)

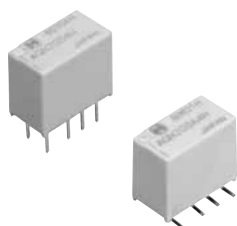

**RoHS compliant**

### FEATURES

- 1. Slim compact size**  
10.6 (L) × 5.7 (W) × 9.0 (H) mm  
.417 (L) × .224 (W) × .354 (H) inch
- 2. High sensitivity single side stable type (Nominal operating power: 100mW) is available**
- 3. Outstanding surge resistance**  
1,500 V 10×160 μs (FCC part 68) (open contacts)  
2,500 V 2×10 μs (Telcordia) (contact and coil)
- 4. The use of twin crossbar contacts ensures high contact reliability**  
AgPd contact is used because of its good sulfide resistance. Adopting low-gas molding material. Coil assembly molding technology which avoids generating volatile gas from coil.

### TYPICAL APPLICATIONS

1. Telephonic equipment
2. Telecommunications equipment
3. Security equipment
4. Test and Measurement equipment
5. Electronic Consumer and Audio Visual equipment

### ORDERING INFORMATION

	<b>AGN</b>	<b>2</b>		<b>0</b>				
Contact arrangement	2: 2 Form C							
Operating function	0: Single side stable 1: 1 coil latching 6: High sensitivity single side stable type							
Type of operation	0: Standard type (B.B.M.)							
Terminal shape	Nil: Standard PC board terminal A: Surface-mount terminal A type S: Surface-mount terminal S type							
Nominal coil voltage (DC)	1H: 1.5V 03: 3V 4H: 4.5V 06: 6V 09: 9V 12: 12V 24: 24V							
Packing style	Nil: Tube packing X: Tape and reel packing (picked from 1/2/3/4 pin side) Z: Tape and reel packing (picked from 5/6/7/8 pin side)							

## TYPES

### 1. Standard PC board terminal

Nominal coil voltage	Single side stable	1 coil latching	High sensitivity single side stable
	Part No.	Part No.	Part No.
1.5 V DC	AGN2001H	AGN2101H	AGN2601H
3 V DC	AGN20003	AGN21003	AGN26003
4.5 V DC	AGN2004H	AGN2104H	AGN2604H
6 V DC	AGN20006	AGN21006	AGN26006
9 V DC	AGN20009	AGN21009	AGN26009
12 V DC	AGN20012	AGN21012	AGN26012
24 V DC	AGN20024	AGN21024	AGN26024

Standard packing: Tube: 50 pcs.; Case: 1,000 pcs.

### 2. Surface-mount terminal

#### 1) Tube packing

Nominal coil voltage	Single side stable	1 coil latching	High sensitivity single side stable
	Part No.	Part No.	Part No.
1.5 V DC	AGN200□1H	AGN210□1H	AGN260□1H
3 V DC	AGN200□03	AGN210□03	AGN260□03
4.5 V DC	AGN200□4H	AGN210□4H	AGN260□4H
6 V DC	AGN200□06	AGN210□06	AGN260□06
9 V DC	AGN200□09	AGN210□09	AGN260□09
12 V DC	AGN200□12	AGN210□12	AGN260□12
24 V DC	AGN200□24	AGN210□24	AGN260□24

□: For each surface-mounted terminal identification, input the following letter. A type: A, S type: S

Standard packing: Tube: 50 pcs.; Case: 1,000 pcs.

#### 2) Tape and reel packing

Nominal coil voltage	Single side stable	1 coil latching	High sensitivity single side stable
	Part No.	Part No.	Part No.
1.5 V DC	AGN200□1HZ	AGN210□1HZ	AGN260□1HZ
3 V DC	AGN200□03Z	AGN210□03Z	AGN260□03Z
4.5 V DC	AGN200□4HZ	AGN210□4HZ	AGN260□4HZ
6 V DC	AGN200□06Z	AGN210□06Z	AGN260□06Z
9 V DC	AGN200□09Z	AGN210□09Z	AGN260□09Z
12 V DC	AGN200□12Z	AGN210□12Z	AGN260□12Z
24 V DC	AGN200□24Z	AGN210□24Z	AGN260□24Z

□: For each surface-mounted terminal identification, input the following letter. A type: A, S type: S

Standard packing: Tape and reel: 500 pcs.; Case: 1,000 pcs.

Notes: 1. Tape and reel packing symbol "Z" is not marked on the relay. "X" type tape and reel packing (picked from 1/2/3/4-pin side) is also available.

2. Please inquire if you require a relay, between 1.5 and 24 V DC, with a voltage not listed.

## RATING

### 1. Coil data

#### 1) Single side stable type

Nominal coil voltage	Pick-up voltage (at 20°C 68°F)	Drop-out voltage (at 20°C 68°F)	Nominal operating current [±10%] (at 20°C 68°F)	Coil resistance [±10%] (at 20°C 68°F)	Nominal operating power	Max. applied voltage (at 20°C 68°F)
1.5 V DC	75%V or less of nominal voltage* (Initial)	10%V or more of nominal voltage* (Initial)	93.8 mA	16 Ω	140 mW	150%V of nominal voltage
3 V DC			46.7 mA	64.2 Ω		
4.5 V DC			31 mA	145 Ω		
6 V DC			23.3 mA	257 Ω		
9 V DC			15.5 mA	579 Ω		
12 V DC			11.7 mA	1,028 Ω		
24 V DC			9.6 mA	2,504 Ω	230 mW	120%V of nominal voltage

#### 2) 1 coil latching type

Nominal coil voltage	Set voltage (at 20°C 68°F)	Reset voltage (at 20°C 68°F)	Nominal operating current [±10%] (at 20°C 68°F)	Coil resistance [±10%] (at 20°C 68°F)	Nominal operating power	Max. applied voltage (at 20°C 68°F)
1.5 V DC	75%V or less of nominal voltage* (Initial)	75%V or less of nominal voltage* (Initial)	66.7 mA	22.5 Ω	100 mW	150%V of nominal voltage
3 V DC			33.3 mA	90 Ω		
4.5 V DC			22.2 mA	202.5 Ω		
6 V DC			16.7 mA	360 Ω		
9 V DC			11.1 mA	810 Ω		
12 V DC			8.3 mA	1,440 Ω		
24 V DC			5.0 mA	4,800 Ω	120 mW	

\*Pulse drive (JIS C 5442-1996)

3) High sensitivity single side stable type

Nominal coil voltage	Set voltage (at 20°C 68°F)	Reset voltage (at 20°C 68°F)	Nominal operating current [±10%] (at 20°C 68°F)	Coil resistance [±10%] (at 20°C 68°F)	Nominal operating power	Max. applied voltage (at 20°C 68°F)
1.5 V DC	80%V or less of nominal voltage* (Initial)	10%V or more of nominal voltage* (Initial)	66.7 mA	22.5 Ω	100 mW	150%V of nominal voltage
3 V DC			33.3 mA	90 Ω		
4.5 V DC			22.2 mA	202.5 Ω		
6 V DC			16.7 mA	360 Ω		
9 V DC			11.1 mA	810 Ω		
12 V DC			8.3 mA	1,440 Ω		
24 V DC			5.0 mA	4,800 Ω	120 mW	120%V of nominal voltage

\*Pulse drive (JIS C 5442-1996)

2. Specifications

Characteristics	Item	Specifications	
Contact	Arrangement	2 Form C	
	Initial contact resistance, max.	Max. 100 mΩ (By voltage drop 6 V DC 1A)	
	Contact material	Stationary contact: AgPd+Au clad Movable contact: AgPd	
Rating	Nominal switching capacity	1 A 30 V DC, 0.3 A 125 V AC (resistive load)	
	Max. switching power	30 W (DC), 37.5 V A (AC) (resistive load)	
	Max. switching voltage	110 V DC, 125 V AC	
	Max. switching current	1 A	
	Min. switching capacity (Reference value)*1	10μA 10 mV DC	
	Nominal operating power	Single side stable	140mW (1.5 to 12 V DC), 230mW (24 V DC)
		High sensitivity single side stable type	100mW (1.5 to 12 V DC), 120mW (24 V DC)
1 coil latching			
Electrical characteristics	Insulation resistance (Initial)	Min. 1,000MΩ (at 500V DC) Measurement at same location as "Initial breakdown voltage" section.	
	Breakdown voltage (Initial)	Between open contacts	750 Vrms for 1min. (Detection current: 10mA)
		Between contact and coil	1,500 Vrms for 1min. (Detection current: 10mA)
		Between contact sets	1,000 Vrms for 1min. (Detection current: 10mA)
	Surge breakdown voltage (Initial)	Between open contacts	1,500 V (10×160μs) (FCC Part 68)
		Between contacts and coil	2,500 V (2×10μs) (Telcordia)
	Temperature rise (at 20°C 68°F)	Max. 50°C (By resistive method, nominal coil voltage applied to the coil; contact carrying current: 1A.)	
	Operate time [Set time] (at 20°C 68°F)	Max. 4 ms [Max. 4 ms] (Nominal coil voltage applied to the coil, excluding contact bounce time.)	
	Release time [Reset time] (at 20°C 68°F)	Max. 4 ms [Max. 4 ms] (Nominal coil voltage applied to the coil, excluding contact bounce time.) (without diode)	
	Mechanical characteristics	Shock resistance	Functional
Destructive			Min. 1,000 m/s <sup>2</sup> (Half-wave pulse of sine wave: 6 ms.)
Vibration resistance		Functional	10 to 55 Hz at double amplitude of 3.3 mm (Detection time: 10μs.)
		Destructive	10 to 55 Hz at double amplitude of 5 mm
Expected life	Mechanical	Min. 5 × 10 <sup>7</sup> (at 180 cpm)	
	Electrical	Min. 10 <sup>5</sup> (1 A 30 V DC resistive), 10 <sup>5</sup> (0.3 A 125 V AC resistive) (at 20 cpm)	
Conditions	Conditions for operation, transport and storage*2	Ambient temperature: (Single side stable, 1 coil latching type) -40°C to +85°C -40°F to +185°F (High sensitivity single side stable type) -40°C to +70°C -40°F to +158°F Humidity: 5 to 85% R.H. (Not freezing and condensing at low temperature)	
	Max. operating speed (at rated load)	20 cpm	
Unit weight		Approx. 1 g .035 oz	

Notes: \*1 This value can change due to the switching frequency, environmental conditions, and desired reliability level, therefore it is recommended to check this with the actual load.

\*2 Refer to "AMBIENT ENVIRONMENT" in GENERAL APPLICATION GUIDELINES.

REFERENCE DATA

1. Max. switching capacity

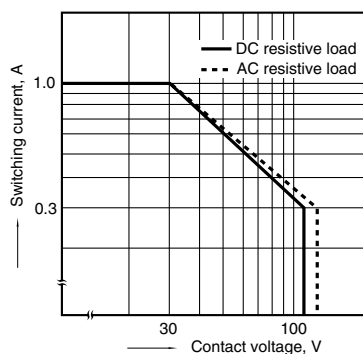

2. Life curve

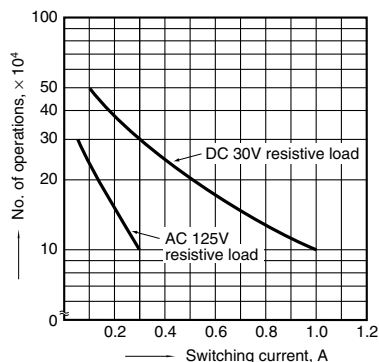

3. Mechanical life

Tested sample: AGN2004H, 15 pcs.  
Operating speed: 180 cpm

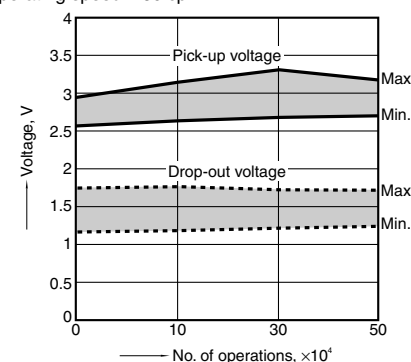

# GN (AGN)

## 4. Electrical life (1A 30V DC resistive load)

Tested sample: AGN2004H, 6 pcs.

Operating speed: 20 cpm

Change of pick-up and drop-out voltage

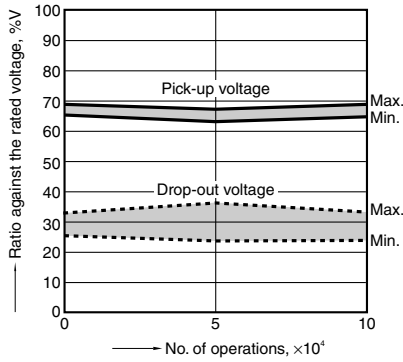

Change of contact resistance

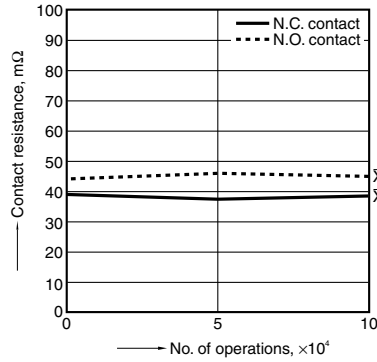

## 5. Coil temperature rise

Tested sample: AGN2004H, AGN20024, 6 pcs.

Point measured: Inside the coil

Ambient temperature: Room temperature

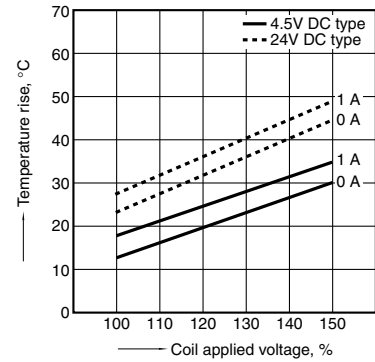

## 6-(1). Operate and release time (without diode)

Tested sample: AGN2004H, 6 pcs.

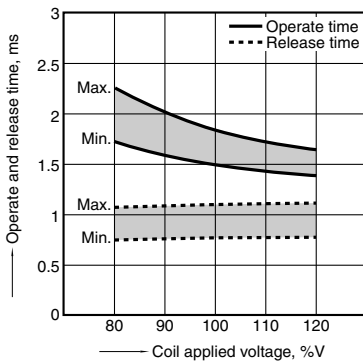

## 6-(2). Operate and release time (with diode)

Tested sample: AGN2004H, 6 pcs.

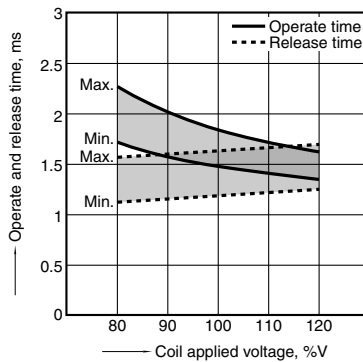

## 7. Ambient temperature characteristics

Tested sample: AGN2004H, 6 pcs.

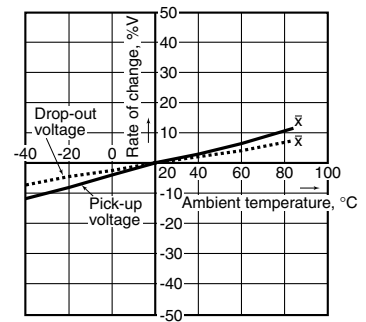

## 8. Malfunctional shock

Tested sample: AGN2004H

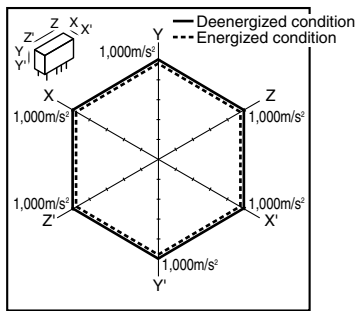

## 9-(1). Influence of adjacent mounting

Tested sample: AGN20012, 6 pcs.

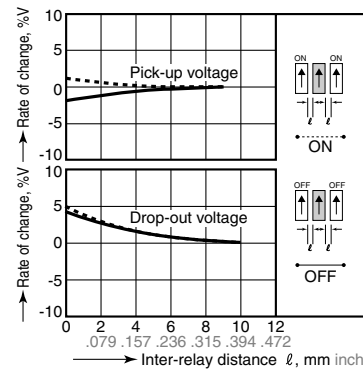

## 9-(2). Influence of adjacent mounting

Tested sample: AGN20012, 6 pcs.

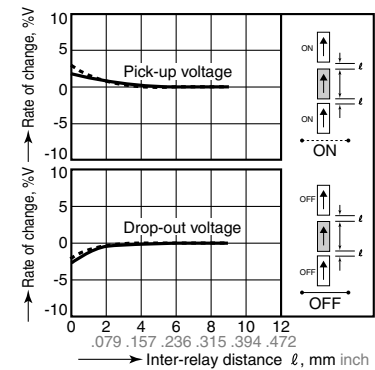

## DIMENSIONS (mm inch)

The CAD data of the products with a **CAD Data** mark can be downloaded from: <http://industrial.panasonic.com/ac/e/>

### 1. PC board terminal

**CAD Data**

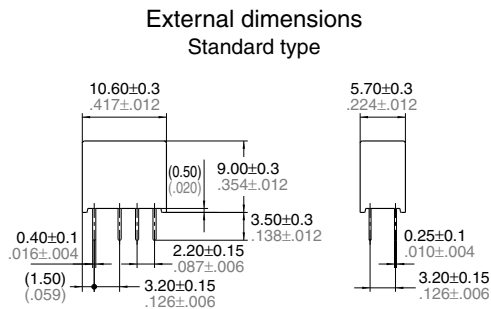

### PC board pattern

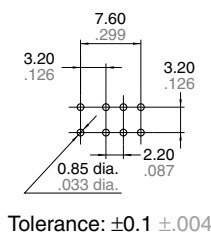

### Schematic (Bottom view)

Single side stable  
High sensitivity  
single side stable

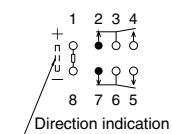

(Deenergized condition)

1 coil latching

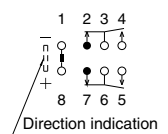

(Reset condition)

2. Surface-mount terminal

CAD Data



Type	External dimensions		Suggested mounting pad (Tolerance: ±0.1 ±.004)	
	Single side stable/1 coil latching/High sensitivity single side stable		Single side stable/1 coil latching/High sensitivity single side stable	
A type				
S type				

Schematic (Top view)

Single side stable  
High sensitivity single side stable

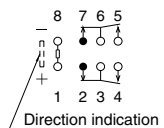

(Deenergized condition)

1 coil latching

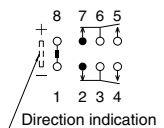

(Reset condition)

NOTES

1. Packing style

1) The relay is packed in a tube with the relay orientation mark on the left side, as shown in the figure below.



2) Tape and reel packing

(A type)

(1)-1 Tape dimensions

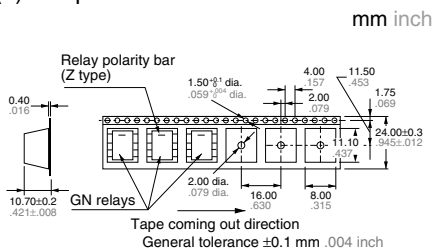

(S type)

(1)-2 Tape dimensions

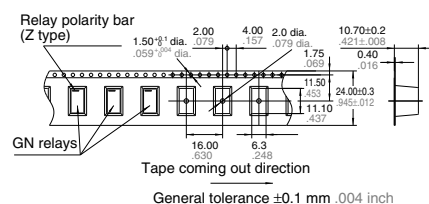

(2) Dimensions of plastic peel

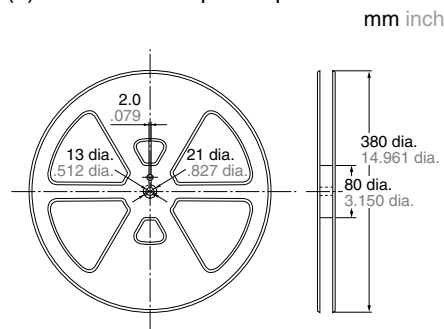

2. Automatic insertion

To maintain the internal function of the relay, the chucking pressure should not exceed the values below.

Chucking pressure in the direction A:

4.9 N {500gf} or less

Chucking pressure in the direction B:

9.8 N {1 kgf} or less

Chucking pressure in the direction C:

9.8 N {1 kgf} or less

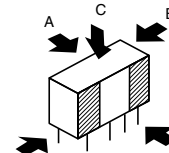

Please chuck the portion. Avoid chucking the center of the relay. In addition, excessive chucking pressure to the pinpoint of the relay should be avoided.

**For general cautions for use, please refer to the "Cautions for use of Signal Relays" or "General Application Guidelines".**

单击下面可查看定价，库存，交付和生命周期等信息

[>>Panasonic\(松下\)](#)