

Multilayer Varistor for ESD pulse [DC voltage lines/High speed signal lines]

Series: **EZJZ, EZJP**

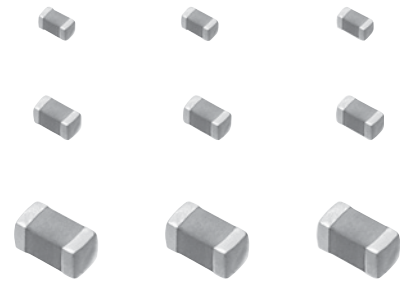

Features

- Excellent ESD suppression due to original advanced material technology
- Having large electrostatic resistance meeting IEC61000-4-2, Level 4 standard
- Having no polarity (bipolar) facilitated replacing Zener Diodes. Capable of replacing 2 Zener Diodes and 1 Capacitor.
- Lead-free plating terminal electrodes enabling great solderability
- Wide range of products is available by adopting multilayer structure, meeting various needs.
- Low capacitance versions for DC voltage lines of high speed busses
- Ultra low capacitance for high speed signal line
- Applicable to high-speed signal lines, such as interfaces (e.g. USB 2.0, IEEE1394, HDMI, and so on), due to our original ultra-low capacitance technology.
- RoHS compliant

As for Packaging Methods, Handling Precautions

Please see Data Files

Explanation of Part Numbers

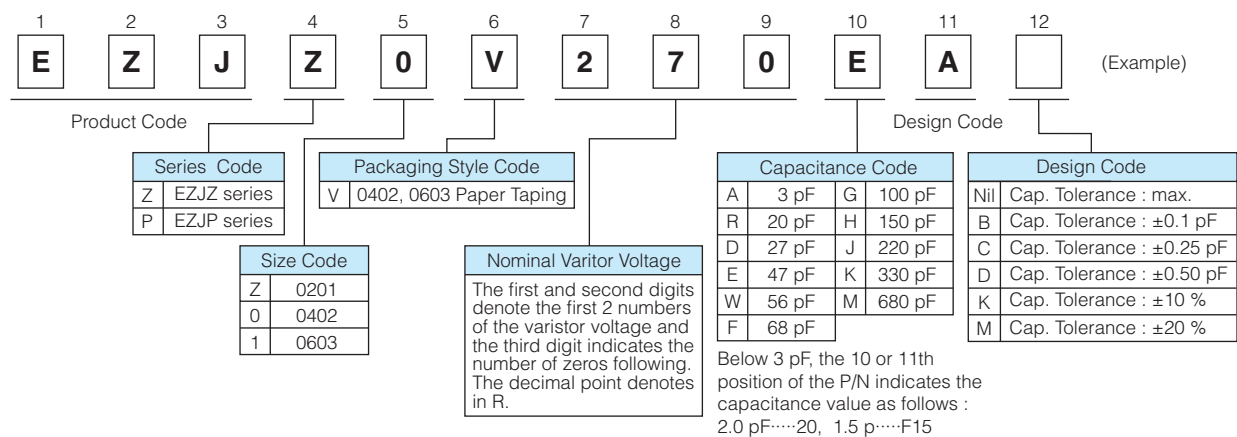

Construction

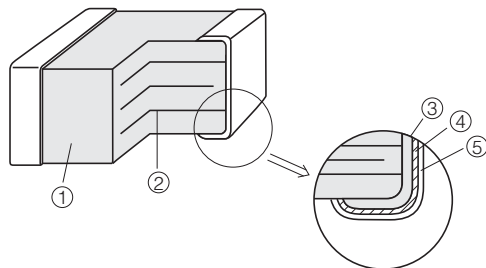

No.	Name
①	Semiconductive Ceramics
②	Internal electrode
③	Substrate electrode
④	Terminal electrode
⑤	Intermediate electrode
	External electrode

Dimensions in mm (not to scale)

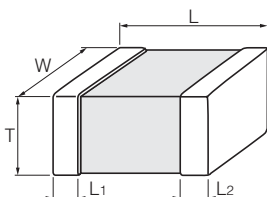

Size Code	Size(inch)	L	W	T	L ₁ , L ₂
Z	0201	0.60±0.03	0.30±0.03	0.30±0.03	0.15±0.05
0	0402	1.00±0.05	0.50±0.05	0.50±0.05	0.2±0.1
1	0603	1.6±0.1	0.8±0.1	0.8±0.1	0.3±0.2

Multilayer Varistor, Low Capacitance Type [High speed signal lines]

Features

- Multilayer monolithic ceramic construction for high speed signal lines
- Ideal for USB 2.0, IEEE1394, and HDMI high speed data busses
- Applicable to high-speed signal lines, such as interfaces (e.g. USB 2.0, IEEE1394, HDMI, and so on), due to our original material technology and multilayer technology.
- Capacitance: 0.8 to 2.1 pF typ.

Recommended Applications

Mobile phone	Antenna circuit, External IF
DSC, DVC	USB2.0, IEEE1394
PC, PDA	USB2.0, IEEE1394, LAN1000BASE
TV, DVD	USB2.0, IEEE1394, HDMI
Game console	Controller, External IF

Ratings and Characteristics

Size	Part No.	Maximum allowable voltage DC (V)	Nominal varistor voltage at 1mA (V)	Capacitance (pF) at 1MHz	Maximum ESD IEC61000-4-2
0402	EZJZ0V80010	10	80	1 max. [0.8 typ.]	Contact discharge : 8kV
	EZJZ0V80015D	5	80	1.5±0.5	
	EZJZ0V500AA	5	50	3 max. [2.1 typ.]	
	EZJZ0V800AA	18	80	3 max. [2.1 typ.]	
	EZJZ0V171AA	18	170	3 max. [2.1 typ.]	
0603	EZJZ1V80010	10	80	1 max. [0.8 typ.]	
	EZJZ1V500AA	5	50	3 max. [2.1 typ.]	
	EZJZ1V800AA	18	80	3 max. [2.1 typ.]	
	EZJZ1V171AA	18	170	3 max. [2.1 typ.]	

- Operating Temperature Range: -40 to 85 °C
- * Recommend soldering method : Reflow soldering

Voltage vs. Current

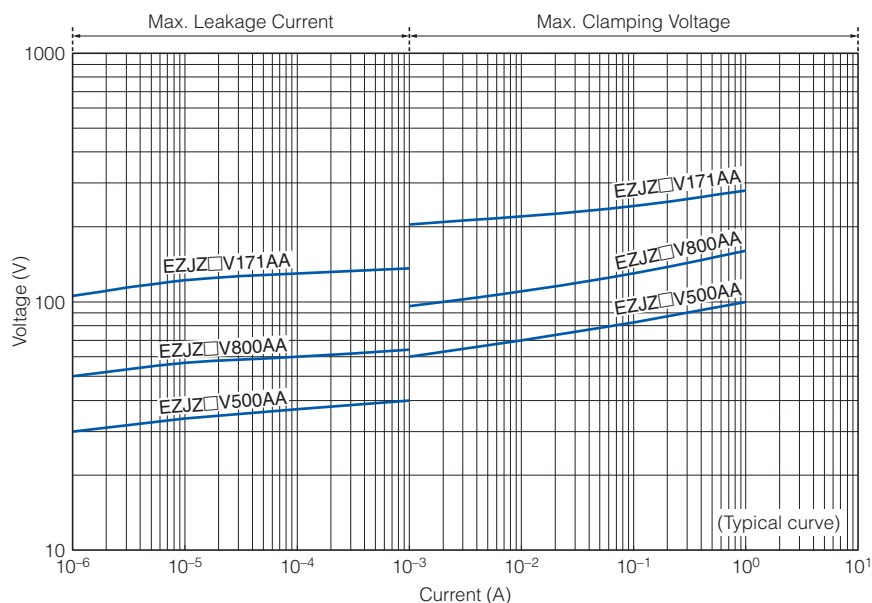

Capacitance vs. Frequency

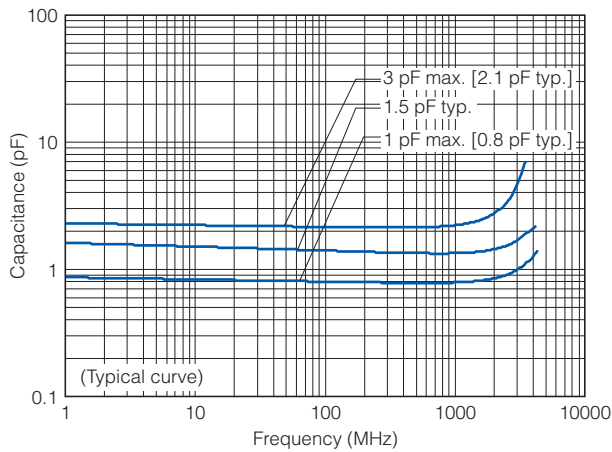

Impedance vs. Frequency

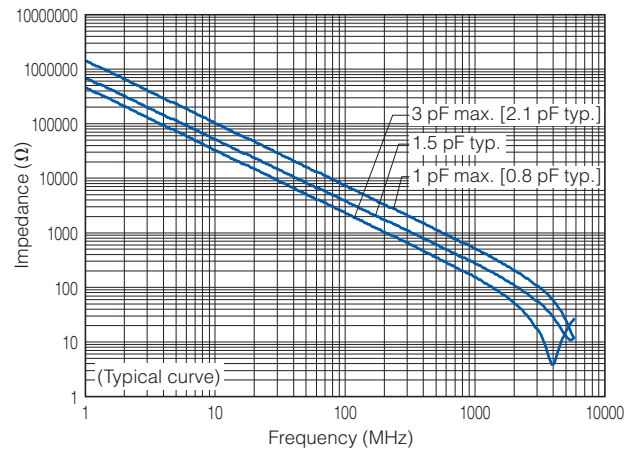

Attenuation vs. Frequency

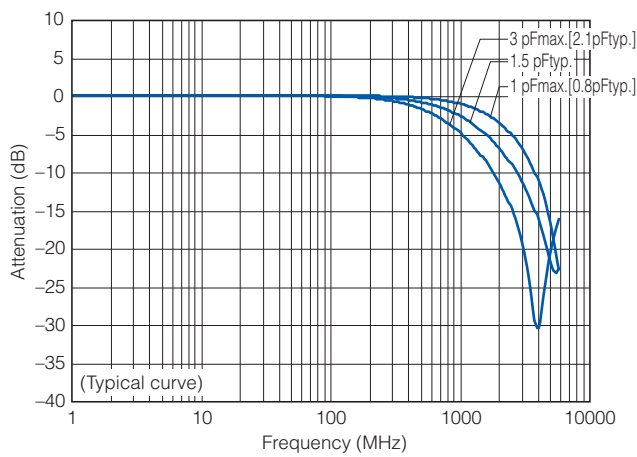

Multilayer Varistor, Low Voltage Type (Standard Type) [DC voltage lines/Low speed signal lines]

Features

Wide variety of products is available by adopting multilayer construction, which achieved wide range of usage, such as application to DC voltage lines and signal lines.

- Circuit voltage

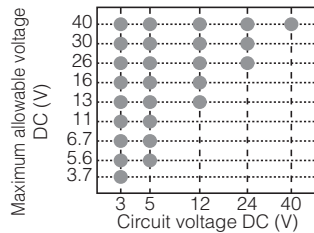

- Varistor voltage : 6.8 to 65 V [at 1 mA]
- Capacitance : 8.5 to 420 pF typ. [at 1 MHz]

Recommended Applications

Mobile phone	SW, LCD, LED, Audio terminal, Battery pack, Memory card, External IF
DSC, DVC	SW, LCD, LED, USB
PC, PDA	SW, LCD, LED, USB
TV, DVD	Audio, Video terminal
Audio	Audio terminal, Microphone, Receiver
Game console	Controller, External IF

Ratings and Characteristics

Size	Part No.	Maximum allowable voltage DC (V)	Nominal varistor voltage at 1mA (V)	Capacitance (pF)		Maximum peak current at 8/20μs, 2times (A)	Maximum ESD IEC61000-4-2
				at 1MHz	at 1kHz		
0201	EZJPZV6R8JA	3.7	6.8	220 max. [180 typ.]	175 typ.	5	Contact discharge 8 kV
	EZJPZV6R8GA	3.7	6.8	100 max. [85 typ.]	100 typ.	5	
	EZJPZV080GA	5.6	8	100 max. [85 typ.]	100 typ.	5	
	EZJPZV120GA	7.5	12	100 max. [85 typ.]	100 typ.	5	
	EZJPZV120DA	7.5	12	27 max. [22 typ.]	33 typ.	1	
	EZJPZV120RA	7.5	12	20 max. [15 typ.]	18 typ.	1	
	EZJPZV150RA	9	15	20 max. [15 typ.]	18 typ.	1	
	EZJPZV270RA	16	27	20 max. [15 typ.]	16.5 typ.	1	
0402	EZJPZV270BA	16	27	10 max. [8.5 typ.]	10 typ.	1	
	EZJP0V6R8MA	3.7	6.8	680 max. [420 typ.]	650 typ.	20	
	EZJP0V6R8GA	3.7	6.8	100 max. [85 typ.]	100 typ.	3	
	EZJP0V080MA	5.6	8	680 max. [420 typ.]	650 typ.	20	
	EZJP0V080KA	5.6	8	330 max. [290 typ.]	480 typ.	15	
	EZJP0V080GA	5.6	8	100 max. [65 typ.]	100 typ.	3	
	EZJP0V080DA	5.6	8	27 max. [22 typ.]	33 typ.	1	
	EZJP0V120JA	6.7	12	220 max. [150 typ.]	175 typ.	10	
	EZJZ0V180HA	11	18	150 max. [120 typ.]	140 typ.	10	
	EZJZ0V220HA	13	22	150 max. [100 typ.]	116 typ.	10	
	EZJP0V270EA	16	27	47 max. [33 typ.]	37 typ.	4	
	EZJP0V270RA	16	27	20 max. [15 typ.]	16.5 typ.	1	
0603	EZJZ0V420WA	30	42	56 max. [40 typ.]	45 typ.	10	
	EZJZ0V650DA	40	65	27 max. [22 typ.]	33 typ.	5	
	EZJP1V120KA	6.7	12	330 max. [250 typ.]	290 typ.	20	
	EZJZ1V180JA	11	18	220 max. [180 typ.]	210 typ.	20	
	EZJZ1V220JA	13	22	220 max. [160 typ.]	185 typ.	20	
	EZJZ1V270GA	16	27	100 max. [85 typ.]	100 typ.	20	
	EZJZ1V270EA	16	27	47 max. [33 typ.]	37 typ.	20	
	EZJZ1V270RA	16	27	20 max. [15 typ.]	16.5 typ.	3	
	EZJZ1V330GA	26	33	100 max. [85 typ.]	100 typ.	20	
	EZJZ1V420FA	30	42	68 max. [55 typ.]	63 typ.	15	
EZJZ1V650DA	40	65	27 max. [22 typ.]	33 typ.	5		

- Operating Temperature Range: -40 to 85 °C * Recommend soldering method : Reflow soldering

Maximum Allowable Voltage	Maximum DC Voltage that can be applied continuously within the operating temperature range
Varistor Voltage	Varistor starting voltage between terminals at DC 1 mA, also known as Breakdown voltage
Maximum Peak Current	Maximum current that can be withstood under the standard pulse 8/20 μs, 2 times based
Maximum ESD	Maximum voltage that can be withstood under ESD based on IEC61000-4-2, 10 times (5 times of each positive-negative polarity)

Voltage vs. Current

● EZJP Series

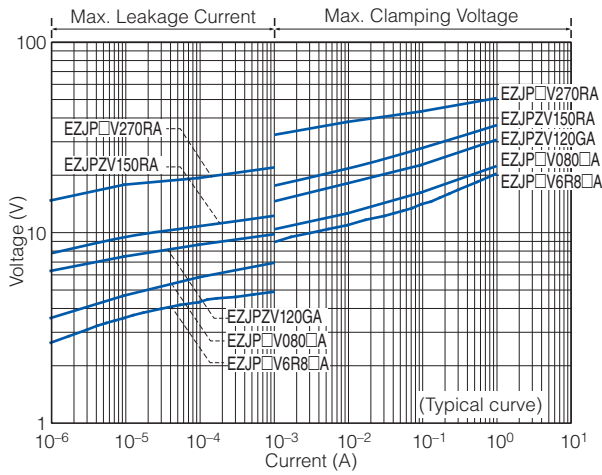

● EZJZ Series

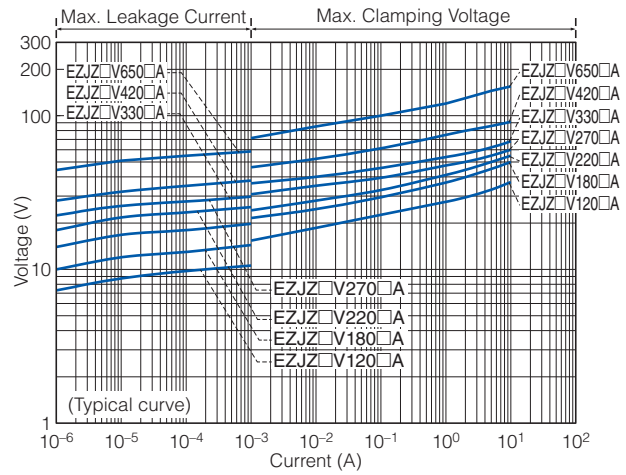

Capacitance vs. Frequency

● EZJP Series

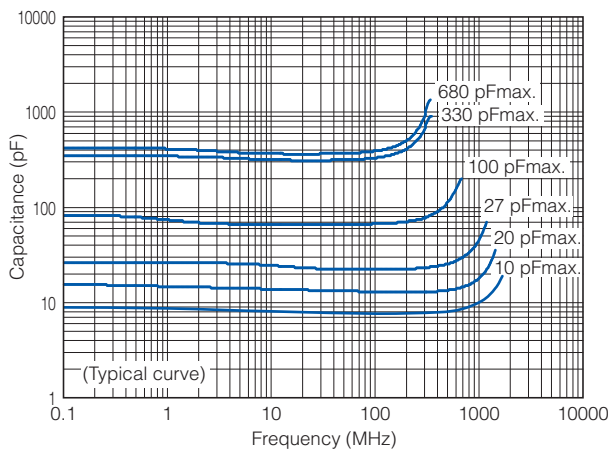

● EZJZ Series

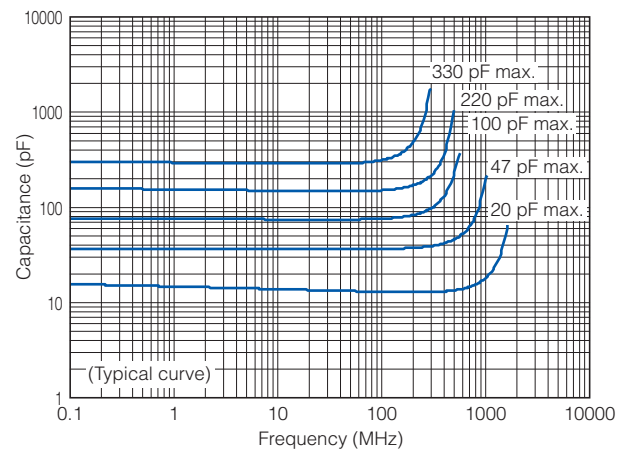

Attenuation vs. Frequency

● EZJP Series

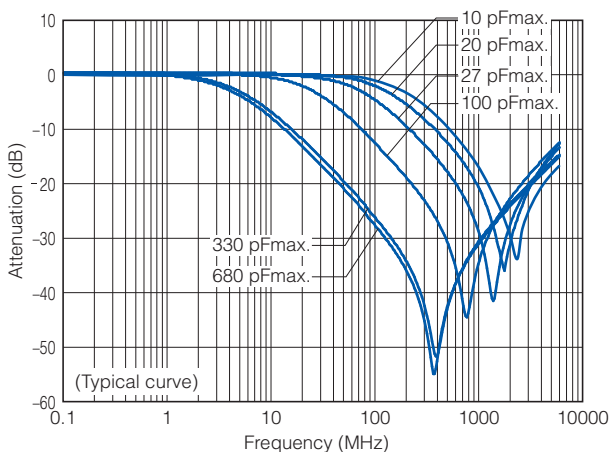

● EZJZ Series

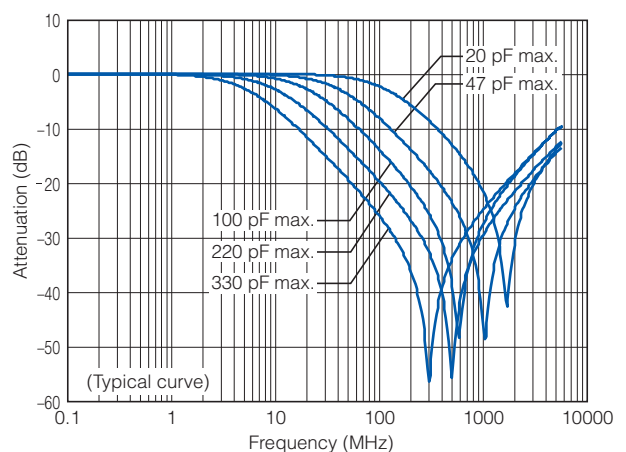

Varistor Characteristics and Equivalent Circuit

A Multilayer Varistor does not have an electrical polarity like zener diodes and is equivalent to total 3 pcs. of 2 zener diodes and 1 capacitor.

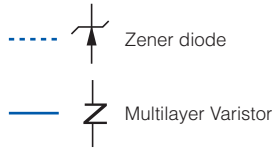
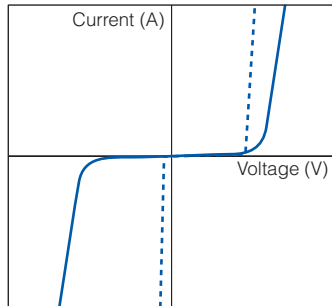

[Equivalent Circuit]

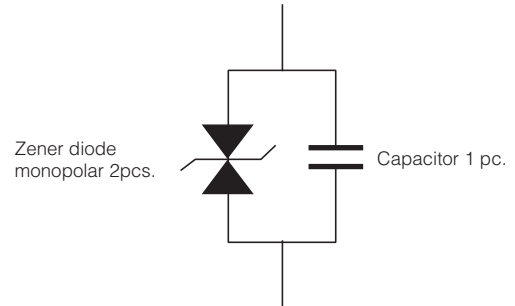

ESD Suppressive Effects

Typical effects of ESD suppression

Test conditions: IEC61000-4-2* Level 4 Contact discharge, 8 kV

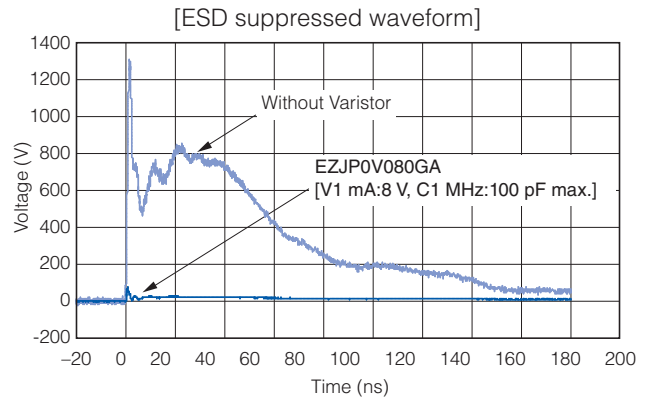
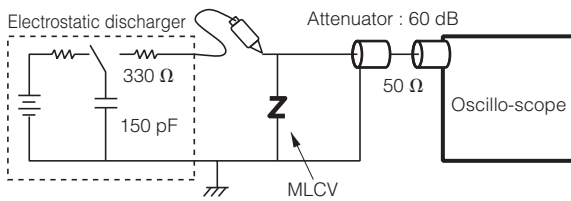

* IEC61000-4-2 ... International Standard of the ESD testing method (HBM) for electronic equipment ability to withstand ESD generated from a human body. It sets 4 levels of severity

Severity	Level 1	Level 2	Level 3	Level 4
Contact discharge	2 kV	4 kV	6 kV	8 kV
Air discharge	2 kV	4 kV	8 kV	15 kV

Replacement of Zener diode

Replacing "Zener diode and Capacitor" with Multilayer Varistor saves both the mounting area and number of components used.

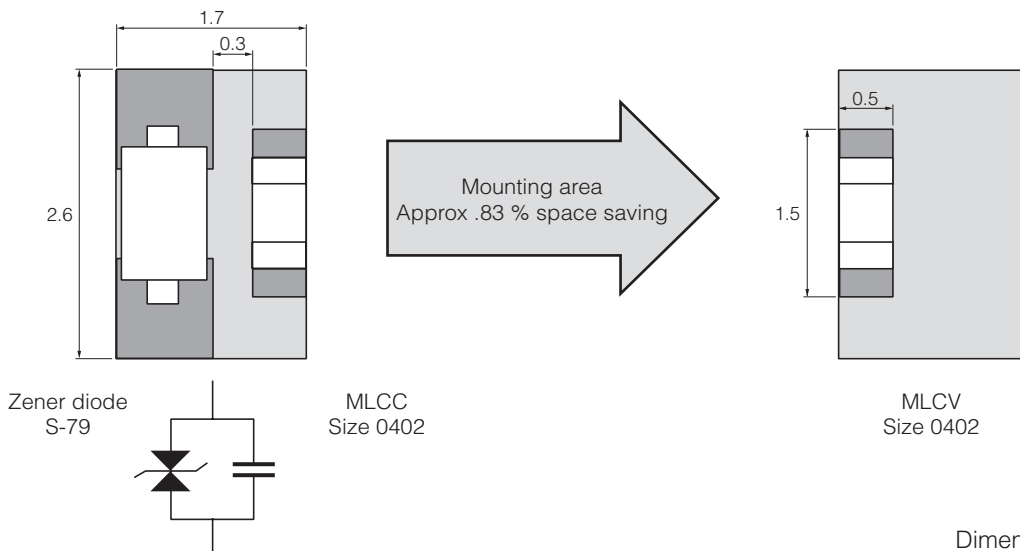

Dimensions in mm

Recommended Applications

Applications	Series	Circuit	Frequency		
			DC	1k	1M
Mobile phones, DSC, PC, PDA, HDD TV (PDP, LC etc.), DVD, DVC, Game consoles, Audio equipment	Series EZJZ, P	Ultra low capacitance (Cap. : 3 pF or less)	[Bar chart showing high performance up to 1G Hz]		
		Low capacitance (Cap. : 20 to 680 pF)	[Bar chart showing performance up to 1M Hz]		
PWR, Photoelectronic sensors, SSR, Motors, Pressure sensors, Proximity switches	Series EZJS	High capacitance (Cap. : 1800 to 22000 pF)	[Bar chart showing performance up to 1k Hz]		

Applications

● Mobile Phone

· Audio lines

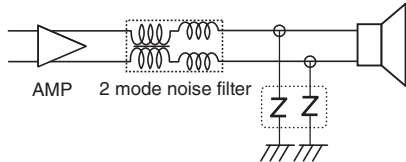

· LED

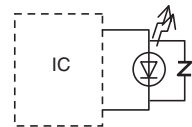

· SW/Keyboard

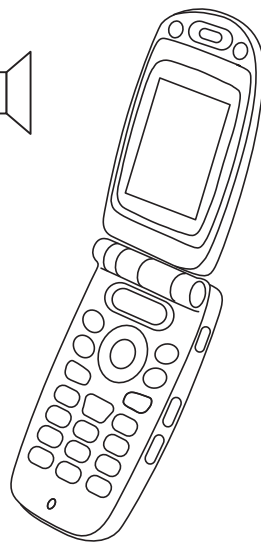
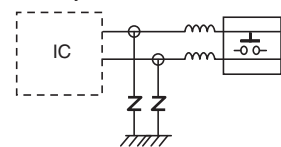

· LCD/Camera lines

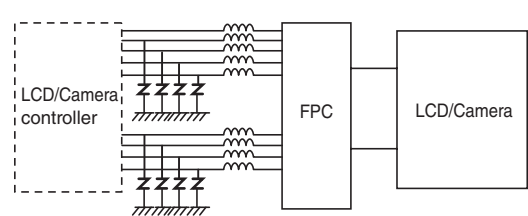

· I/O data lines

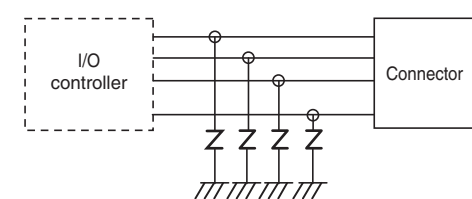

● USB1.1/2.0 lines

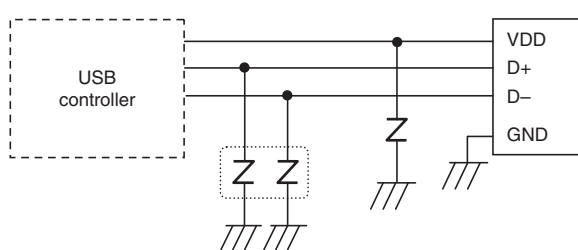

● IEEE1394 lines

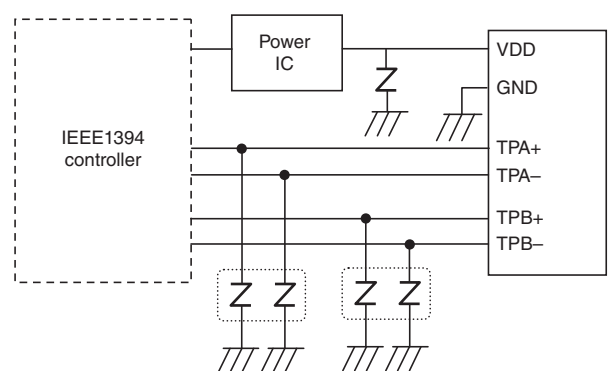

● HDMI lines

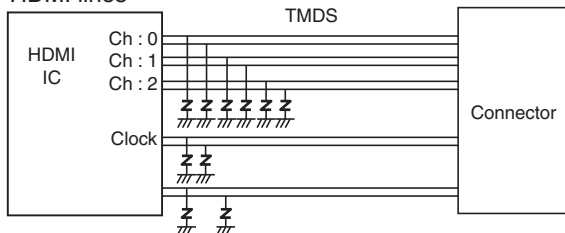

Performance and Testing Methods

Characteristics	Specifications	Testing Method															
Standard test conditions		Electrical characteristics shall be measured under the following conditions. Temp. : 5 to 35 °C, Relative humidity : 85 % or less															
Varistor voltage	To meet the specified value.	The Varistor voltage is the voltage (V_c , or V_{cMA}) between both end terminals of a Varistor when specified current (C_{mA}) is applied to it. The measurement shall be made as quickly as possible to avoid heating effects.															
Maximum allowable voltage	To meet the specified value.	The maximum DC voltage that can be applied continuously to a varistor.															
Capacitance	To meet the specified value.	Capacitance shall be measured at the specified frequency, bias voltage 0 V, and measuring voltage 0.2 to 2 Vrms.															
Maximum peak current	To meet the specified value.	The maximum current measured (Varistor voltage tolerance is within $\pm 10\%$) when a standard impulse current of $8/20 \mu$ seconds is applied twice with an interval of 5 minutes.															
Maximum ESD	To meet the specified value.	The maximum ESD measured (while the varistor voltage is within $\pm 30\%$ of its nominal value) when exposed to ESD 10 times (five times for each positive-negative polarity) based on IEC61000-4-2.															
Solder ability	To meet the specified value.	The part shall be immersed into a soldering bath under the conditions below. Solder: H63A Soldering flux : Ethanol solution of rosin (Concentration approx. 25 wt%) Soldering temp. : 230 ± 5 °C Period : 4 ± 1 s Soldering position: Immerse both terminal electrodes until they are completely into the soldering bath.															
Resistance to soldering heat	$\Delta V_c / V_c$: within $\pm 10\%$	After the immersion, leave the part for 24 ± 2 hours under the standard condition, then evaluate its characteristics. Soldering conditions are specified below: Soldering conditions : 270 °C, 3 s / 260 °C, 10 s Soldering position : Immerse both terminal electrodes until they are completely into the soldering bath.															
Temperature cycling	$\Delta V_c / V_c$: within $\pm 10\%$	After repeating the cycles stated below for specified number of times, leave the part for 24 ± 2 hours, then evaluate its characteristics. Cycle : 5 cycles <table border="1" style="margin-left: auto; margin-right: auto;"> <thead> <tr> <th>Step</th> <th>Temperature</th> <th>Period</th> </tr> </thead> <tbody> <tr> <td>1</td> <td>Max. Operating Temp.</td> <td>30 ± 3 min</td> </tr> <tr> <td>2</td> <td>Ordinary temp.</td> <td>3 min max.</td> </tr> <tr> <td>3</td> <td>Min. Operating Temp.</td> <td>30 ± 3 min</td> </tr> <tr> <td>4</td> <td>Ordinary temp.</td> <td>3 min max.</td> </tr> </tbody> </table>	Step	Temperature	Period	1	Max. Operating Temp.	30 ± 3 min	2	Ordinary temp.	3 min max.	3	Min. Operating Temp.	30 ± 3 min	4	Ordinary temp.	3 min max.
Step	Temperature	Period															
1	Max. Operating Temp.	30 ± 3 min															
2	Ordinary temp.	3 min max.															
3	Min. Operating Temp.	30 ± 3 min															
4	Ordinary temp.	3 min max.															
Biased Humidity	$\Delta V_c / V_c$: within $\pm 10\%$	After conducting the test under the conditions specified below, leave the part 24 ± 2 hours, then evaluate its characteristics. Temp. : 40 ± 2 °C Humidity : 90 to 95 %RH Applied voltage : Maximum allowable voltage (Individually specified) Period : $500 + 24 / 0$ h															
High temperature exposure (dry heat)	$\Delta V_c / V_c$: within $\pm 10\%$	After conducting the test under the conditions specified below, leave the part 24 ± 2 hours, then evaluate its characteristics. Temp. : Maximum operating temperature ± 3 °C (Individually specified) Applied voltage : Maximum allowable voltage (Individually specified) Period : $500 + 24 / 0$ h															

Guidelines and precautions regarding the technical information and use of our products described in this online catalog.

- If you want to use our products described in this online catalog for applications requiring special qualities or reliability, or for applications where the failure or malfunction of the products may directly jeopardize human life or potentially cause personal injury (e.g. aircraft and aerospace equipment, traffic and transportation equipment, combustion equipment, medical equipment, accident prevention, anti-crime equipment, and/or safety equipment), it is necessary to verify whether the specifications of our products fit to such applications. Please ensure that you will ask and check with our inquiry desk as to whether the specifications of our products fit to such applications use before you use our products.
- The quality and performance of our products as described in this online catalog only apply to our products when used in isolation. Therefore, please ensure you evaluate and verify our products under the specific circumstances in which our products are assembled in your own products and in which our products will actually be used.
- If you use our products in equipment that requires a high degree of reliability, regardless of the application, it is recommended that you set up protection circuits and redundancy circuits in order to ensure safety of your equipment.
- The products and product specifications described in this online catalog are subject to change for improvement without prior notice. Therefore, please be sure to request and confirm the latest product specifications which explain the specifications of our products in detail, before you finalize the design of your applications, purchase, or use our products.
- The technical information in this online catalog provides examples of our products' typical operations and application circuits. We do not guarantee the non-infringement of third party's intellectual property rights and we do not grant any license, right, or interest in our intellectual property.
- If any of our products, product specifications and/or technical information in this online catalog is to be exported or provided to non-residents, the laws and regulations of the exporting country, especially with regard to security and export control, shall be observed.

<Regarding the Certificate of Compliance with the EU RoHS Directive/REACH Regulations>

- The switchover date for compliance with the RoHS Directive/REACH Regulations varies depending on the part number or series of our products.
- When you use the inventory of our products for which it is unclear whether those products are compliant with the RoHS Directive/REACH Regulation, please select "Sales Inquiry" in the website inquiry form and contact us.

We do not take any responsibility for the use of our products outside the scope of the specifications, descriptions, guidelines and precautions described in this online catalog.

Multilayer Varistors, Chip Type

Series: EZJZ, EZJP (For DC voltage lines, high speed signal lines)

Series: EZJS (For DC voltage lines)

Handling Precautions

[Precautions]

- **Do not use the products beyond the descriptions in this product catalog.**
- **This product catalog guarantees the quality of the products as individual components. Before you use the products, please make sure to check and evaluate the products in the circumstance where they are installed in your product.**

! Safety Precautions

Multilayer Varistors (hereafter referred to as "Varistors") should be used for general purpose applications as countermeasures against ESD and noise found in consumer electronics (audio/visual, home, office, information & communication) equipment. When subjected to severe electrical, environmental, and/or mechanical stress beyond the specifications, as noted in the Ratings and Specified Conditions section, the Varistors' performance may be degraded, or become failure mode, such as short circuit mode and open-circuit mode.

If you use under the condition of short-circuit, heat generation of Varistors will occur by running large current due to application of voltage. There are possibilities of smoke emission, substrate burn-out, and, in the worst case, fire. For products which require high safety levels, please carefully consider how a single malfunction can affect your product. In order to ensure the safety in the case of a single malfunction, please design products with fail-safe, such as setting up protecting circuits, etc.

We are trying to improve the quality and the reliability, but the durability differs depending on the use environment and the use conditions. On use, be sure to confirm the actual product under the actual use conditions.

- For the following applications and conditions, please be sure to consult with our sales representative in advance and to exchange product specifications which conform to such applications.
 - When your application may have difficulty complying with the safety or handling precautions specified below.
 - High-quality and high-reliability required devices that have possibility of causing hazardous conditions, such as death or injury (regardless of directly or indirectly), due to failure or malfunction of the product.
- ① Aircraft and Aerospace Equipment (artificial satellite, rocket, etc.)
 - ② Submarine Equipment (submarine repeating equipment, etc.)
 - ③ Transportation Equipment (motor vehicles, airplanes, trains, ship, traffic signal controllers, etc.)
 - ④ Power Generation Control Equipment
(atomic power, hydroelectric power, thermal power plant control system, etc.)
 - ⑤ Medical Equipment (life-support equipment, pacemakers, dialysis controllers, etc.)
 - ⑥ Information Processing Equipment (large scale computer systems, etc.)
 - ⑦ Electric Heating Appliances, Combustion devices (gas fan heaters, oil fan heaters, etc.)
 - ⑧ Rotary Motion Equipment
 - ⑨ Security Systems
 - ⑩ And any similar types of equipment

! Strict Observance**1. Confirmation of Rated Performance**

The Varistors shall be operated within the specified rating/performance.

Applications exceeding the specifications may cause deteriorated performance and/or breakdown, resulting in degradation and/or smoking or ignition of products. The following are strictly observed.

- (1) The Varistors shall not be operated beyond the specified operating temperature range.
- (2) The Varistors shall not be operated in excess of the specified maximum allowable voltage.
- (3) The Varistors shall not be operated in the circuits to which surge current and ESD that exceeds the specified maximum peak current and maximum ESD.
- (4) Never use for AC power supply circuits.

2. The Varistors shall not be mounted near flammables.

Operating Conditions and Circuit Design

1. Circuit Design

1.1 Operating Temperature and Storage Temperature

When operating a components-mounted circuit, please be sure to observe the “Operating Temperature Range”, written in delivery specifications. Storage temperature of PCB after mounting Varistors, which is not operated, should be within the specified “Storage Temperature Range” in the delivery specifications. Please remember not to use the product under the condition that exceeds the specified maximum temperature.

1.2 Operating Voltage

The Varistors shall not be operated in excess of the “Maximum allowable voltage”. If the Varistors are operated beyond the specified Maximum allowable voltage, it may cause short and/or damage due to thermal run away. The circuit that continuously applies high frequency and/or steep pulse voltage please examines the reliability of the Varistor even if it is used within a “Maximum allowable voltage”. Also, it would be safer to check also the safety and reliability of your circuit.

1.3 Self-heating

The surface temperature of the Varistors shall be under the specified Maximum Operating Temperature in the Specifications including the temperature rise caused by self-heating. Check the temperature rise of the Varistor in your circuit.

1.4 Environmental Restrictions

The Varistors does not take the use under the following special environments into consideration. Accordingly, the use in the following special environments, and such environmental conditions may affect the performance of the product; prior to use, verify the performance, reliability, etc. thoroughly.

- ① Use in liquids such as water, oil, chemical, and organic solvent.
- ② Use under direct sunlight, in outdoor or in dusty atmospheres.
- ③ Use in places full of corrosive gases such as sea breeze, Cl₂, H₂S, NH₃, SO₂, and NO_x.
- ④ Use in environment with large static electricity or strong electromagnetic waves or strong radial ray.
- ⑤ Where the product is close to a heating component, or where an inflammable such as a polyvinyl chloride wire is arranged close to the product.
- ⑥ Where this product is sealed or coated with resin etc.
- ⑦ Where solvent, water, or water-soluble detergent is used in flux cleaning after soldering.
(Pay particular attention to water-soluble flux.)
- ⑧ Use in such a place where the product is wetted due to dew condensation.
- ⑨ Use the product in a contaminated state.
Ex.) Do not handle the product such as sticking sebum directly by touching the product after mounting printed circuit board.
- ⑩ Under severe conditions of vibration or impact beyond the specified conditions found in the Specifications.

2. Design of Printed Circuit Board

2.1 Selection of Printed Circuit Boards

There is a possibility of performance deterioration by heat shock (temperature cycles), which causes cracks, from alumina substrate. Please confirm that the substrate you use does not deteriorate the Varistors' quality.

2.2 Design of Land Pattern

- 1) Recommended land dimensions are shown below. Use the proper amount of solder in order to prevent cracking. Using too much solder places excessive stress on the Varistors.

Recommended Land Dimensions(Ex.)

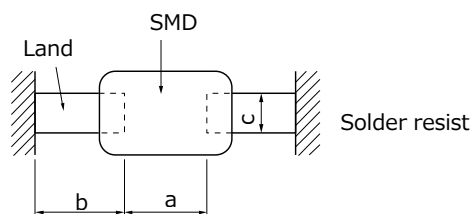

Size Code/EIA	Component dimensions			Unit (mm)		
	L	W	T	a	b	c
Z(0201)	0.6	0.3	0.3	0.2 to 0.3	0.25 to 0.30	0.2 to 0.3
0(0402)	1.0	0.5	0.5	0.4 to 0.5	0.4 to 0.5	0.4 to 0.5
1(0603)	1.6	0.8	0.8	0.8 to 1.0	0.6 to 0.8	0.6 to 0.8
2(0805)	2.0	1.25	0.8 to 1.25	0.8 to 1.2	0.8 to 1.0	0.8 to 1.0

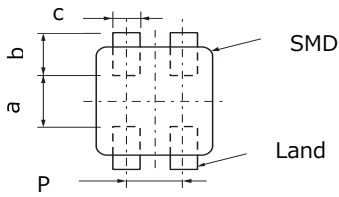

Size Code/EIA	Component dimensions			Unit (mm)			
	L	W	T	a	b	c	P
S (0504 2Array)	1.37	1.0	0.6	0.3 to 0.4	0.45 to 0.55	0.3 to 0.4	0.54 to 0.74

(2) The land size shall be designed to have equal space, on both right and left side. If the amount of solder on the right land is different from that of the left land, the component may be cracked by stress since the side with a larger amount of solder solidifies later during cooling.

Recommended Amount of

(a) Excessive amount (b) Proper amount (c) Insufficient amount

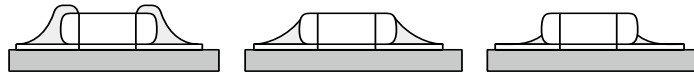

2.3 Utilization of Solder Resist

- (1) Solder resist shall be utilized to equalize the amounts of solder on both sides.
- (2) Solder resist shall be used to divide the pattern for the following cases;
 - Components are arranged closely.
 - The Varistor is mounted near a component with lead wires.
 - The Varistor is placed near a chassis.

See the table right.

Prohibited Applications and Recommended Applications

Item	Prohibited applications	Improved applications by pattern division
Mixed mounting with a component with lead wires	The lead wire of a Component With lead wires 	Solder resist
Arrangement near chassis	Chassis Solder(ground solder) Electrode pattern 	Solder resist
Retro-fitting of component with lead wires	A lead wire of Retrofitted component Soldering iron iron 	Solder resist
Lateral arrangement	Portion to be Excessively soldered Land 	Solder resist

2.4 Component Layout

To prevent the crack of Varistors, place it on the position that could not easily be affected by the bending stress of substrate while going through procedures after mounting or handling.

- (1) To minimize mechanical stress caused by the warp or bending of a PC board, please follow the recommended Varistors' layout below.

Prohibited layout	Recommended layout
	 Layout the Varistors sideways against the stressing direction.

- (2) The following layout is for your reference since mechanical stress near the dividing/breaking position of a PC board varies depending on the mounting position of the Varistors.

Magnitude of stress
 $A > B = C > D > E$

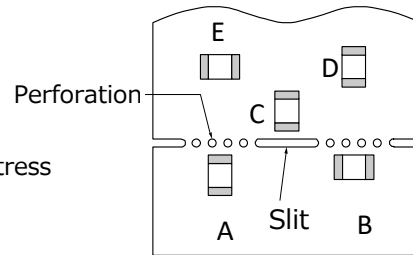

- (3) The magnitude of mechanical stress applied to the Varistors when dividing the circuit board in descending order is as follows: push back < slit < V-groove < perforation. Also take into account the layout of the Varistors and the dividing/breaking method.

2.5 Mounting Density and Spaces

Intervals between components should not be too narrow to prevent the influence from solder bridges and solder balls. The space between components should be carefully determined.

Precautions for Assembly

1. Storage

- (1) The Varistors shall be stored between 5 to 40 °C and 20 to 70 % RH, not under severe conditions of high temperature and humidity.
- (2) If stored in a place where humidity, dust, or corrosive gasses (hydrogen sulfide, sulfurous acid, hydrogen chloride and ammonia, etc.) are contained, the solderability of terminal electrodes will be deteriorated. In addition, storage in a place where the heat or direct sunlight exposure occurs will cause mounting problems due to deformation of tapes and reels and components and taping/reels sticking together.
- (3) Do not store components longer than 6 months. Check the solderability of products that have been stored for more than 6 months before use.

2. Adhesives for Mounting

- (1) The amount and viscosity of an adhesive for mounting shall be such that the adhesive will not flow off on the land during its curing.
- (2) If the amount of adhesive is insufficient for mounting, the Varistors may fall off after or during soldering.
- (3) Low-viscosity of the adhesive causes displacement of Varistors.
- (4) The heat-curing methods for adhesive are ultraviolet radiation, far-infrared radiation, and so on. In order to prevent the terminal electrodes of the Varistors from oxidizing, the curing shall be under the following conditions: 160 °C max., for 2 minutes max.
- (5) Insufficient curing may cause the Varistors to fall off after or during soldering. In addition, insulation resistance between terminal electrodes may deteriorate due to moisture absorption. In order to prevent these problems, please observe proper curing conditions.

3. Chip Mounting Consideration

- (1) When mounting the Varistors components on a PC board, the Varistor bodies shall be free from excessive impact loads such as mechanical impact or stress due to the positioning, pushing force and displacement of vacuum nozzles during mounting.
- (2) Maintenance and inspection of the Chip Mounter must be performed regularly.
- (3) If the bottom dead center of the vacuum nozzle is too low, the Varistor will crack from excessive force during mounting. Please refer to the following precautions and recommendations.
 - (a) Set and adjust the bottom dead center of the vacuum nozzles to the upper surface of the PC board after correcting the warp of the PC board.
 - (b) Set the pushing force of the vacuum nozzle during mounting to 1 to 3 N in static load.
 - (c) For double surface mounting, apply a supporting pin on the rear surface of the PC board to suppress the bending of the PC board in order to minimize the impact of the vacuum nozzles. Typical examples are shown in the table below secondary.
 - (d) Adjust the vacuum nozzles so that their bottom dead center during mounting is not too low.

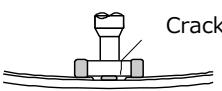
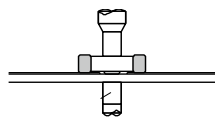
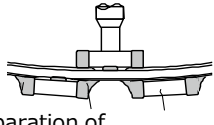
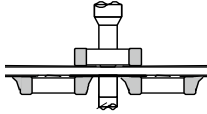
Item	Prohibited mounting	Recommended mounting
Single surface mounting	 Crack	 Supporting pin The supporting pin does not necessarily have to be positioned
Double surface mounting	 Separation of Crack	 Supporting pin

- (4) The closing dimensions of the positioning chucks shall be controlled. Maintenance and replacement of positioning chucks shall be performed regularly to prevent chipping or cracking of the Varistors caused by mechanical impact during positioning due to worn positioning chucks.
- (5) Maximum stroke of the nozzle shall be adjusted so that the maximum bending of PC board does not exceed 0.5 mm at 90 mm span. The PC board shall be supported by an adequate number of supporting pins.

4. Selection of Soldering Flux

Soldering flux may seriously affect the performance of the Varistors. Please confirm enough whether the soldering flux have an influence on performance of the Varistors or not, before using.

5. Soldering

5.1 Flow Soldering

When conducting flow soldering, stress from abrupt temperature change is applied to the Varistors, so the temperature, especially temperature of solder should be controlled very carefully. Varistors should not be subjected to abrupt temperature change because it causes occurrence of thermal cracks as a result of excessive thermal stress inside of the Varistors from flow soldering. You should be careful to temperature difference. Therefore it is essential that soldering process follow these recommended conditions.

- (1) Application of Soldering flux :
The soldering flux shall be applied to the mounted Varistors thinly and uniformly by foaming method.
- (2) Preheating : Conduct sufficient pre-heating, and make sure that the temperature difference between solder and Varistors' surface is 150 °C or less.
- (3) Immersion into Soldering bath :
The Varistors shall be immersed into a soldering bath of 240 to 260 °C for 3 to 5 seconds.
- (4) Gradual Cooling : After soldering, avoid rapid cooling (forced cooling) and conduct gradual cooling, so that thermal cracks do not occur.
- (5) Flux Cleaning : When the Varistors are immersed into a cleaning solvent, be sure that the surface temperatures of devices do not exceed 100 °C.
- (6) Performing flow soldering once under the conditions shown in the figure below
[Recommended profile of Flow soldering (Ex.)] will not cause any problems.
However, pay attention to the possible warp and bending of the PC board.

Recommended profile of Flow Soldering (Ex.)

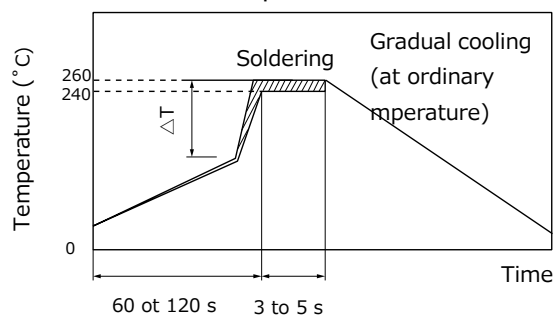

<ΔT: Allowable temperature difference>

Size/EIA	Temp. Tol.
0603	T ≤ 150 °C

For products specified in individual specifications, avoid flow soldering.

5.2 Reflow Soldering

The reflow soldering temperature conditions are composed of temperature curves of Preheating, Temp. rise, Heating, Peak and Gradual cooling. Large temperature difference inside the Varistors caused by rapid heat application to the Varistors may lead to excessive thermal stresses, contributing to the thermal cracks. The Preheating temperature requires controlling with great care so that tombstone phenomenon may be prevented.

Recommended profile of Reflow Soldering (Ex.)

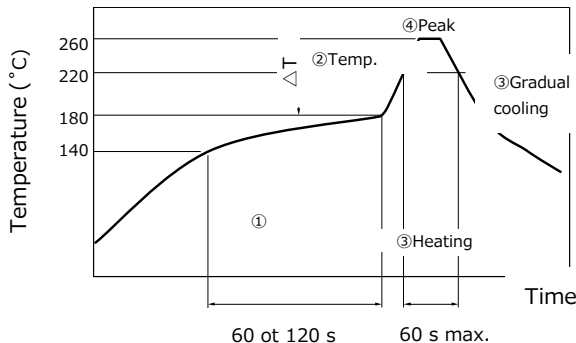

Item	Temperature	Period or Speed
① Preheating	140 to 180 °C	60 to 120 s
② Temp. rise	Preheating temp to Peak temp.	2 to 5 °C / s
③ Heating	220 °C min.	60 s max.
④ Peak	260 °C max.	10 s max.
⑤ Gradual cooling	Peak temp. to 140 °C	1 to 4 °C / s

Size/EIA	Temp. Tol.
0201 to 0805, 0504	T ≤ 150 °C

ΔT : Allowable temperature difference $\Delta T \leq 150$ °C

The rapid cooling (forced cooling) during Gradual cooling part should be avoided, because this may cause defects such as the thermal cracks, etc. When the Varistors are immersed into a cleaning solvent, make sure that the surface temperatures of the devices do not exceed 100 °C. Performing reflow soldering twice under the conditions shown in the figure above [Recommended profile of Flow soldering (Ex.)] will not cause any problems.

However, pay attention to the possible warp and bending of the PC board.

Recommended soldering condition is for the guideline for ensuring the basic characteristics of the components, not for the stable soldering conditions. Conditions for proper soldering should be set up according to individual conditions. The temperature of this product at the time of mounting changes depending on mounting conditions, therefore, please confirm that Product surface becomes the specified temperature when mounting it on the end product.

5.3 Hand Soldering

Hand soldering typically causes significant temperature change, which may induce excessive thermal stresses inside the Varistors, resulting in the thermal cracks, etc. In order to prevent any defects, the following should be observed.

- Control the temperature of the soldering tips with special care.
- Avoid the direct contact of soldering tips with the Varistors and/or terminal electrodes.
- Do not reuse dismantled Varistors.

(1) Condition 1 (with preheating)

- Soldering : Use thread solder (Φ 1.0 mm or below) which contains flux with low chlorine, developed for precision electronic equipment.
- Preheating : Conduct sufficient preheating, and make sure that the temperature difference between solder and Varistors' surface is 150 °C or less.
- Temperature of Iron tip: 300 °C max.
(The required amount of solder shall be melted in advance on the soldering tip.)
- Gradual cooling : After soldering, the Varistors shall be cooled gradually at room temperature.

Recommended profile of Hand soldering (Ex.)

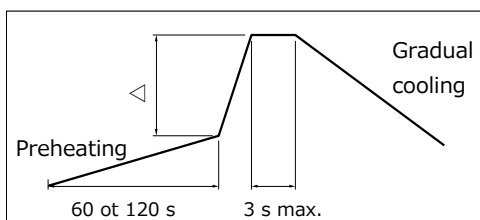

ΔT : Allowable temperature difference $\Delta T \leq 150$ °C

- (2) Condition 2 (without preheating)
 Hand soldering can be performed without preheating, by following the conditions below:
- (a) Soldering iron tip shall never directly touch the ceramic and terminal electrodes of the Varistors.
 - (b) The lands are sufficiently preheated with a soldering iron tip before sliding the soldering iron tip to the terminal electrodes of the Varistors for soldering.

Conditions of Hand soldering without preheating

Item	Condition
Temperature of Iron tip	270 °C max.
Wattage	20 W max.
Shape of Iron tip	Φ 3 mm max.
Soldering time with a soldering iron	3 s max.

6. Post Soldering Cleaning

6.1 Cleaning solvent

Soldering flux residue may remain on the PC board if cleaned with an inappropriate solvent. This may deteriorate the performance of Varistors, especially insulation resistance.

6.2 Cleaning conditions

Inappropriate cleaning conditions such as insufficient cleaning or excessive cleaning may impair the electrical characteristics and reliability of the Varistors.

- (1) Insufficient cleaning can lead to :
 - (a) The halogen substance found in the residue of the soldering flux may cause the metal of terminal electrodes to corrode.
 - (b) The halogen substance found in the residue of the soldering flux on the surface of the Varistors may change resistance values.
 - (c) Water-soluble soldering flux may have more remarkable tendencies of (a) and (b) above compared to those of rosin soldering flux.
- (2) Excessive cleaning can lead to :
 - (a) When using ultrasonic cleaner, make sure that the output is not too large, so that the substrate will not resonate. The resonance causes the cracks in Varistors and/or solders, and deteriorates the strength of the terminal electrodes. Please follow these conditions for Ultrasonic cleaning:
 - Ultrasonic wave output : 20 W/L max.
 - Ultrasonic wave frequency : 40 kHz max.
 - Ultrasonic wave cleaning time : 5 min. max.

6.3 Contamination of Cleaning solvent

Cleaning with contaminated cleaning solvent may cause the same results as that of insufficient cleaning due to the high density of liberated halogen.

7. Inspection Process

The pressure from measuring terminal pins might bend the PCB when implementing circuit inspection after mounting Varistors on PCB, and as a result, cracking may occur.

- (1) Mounted PC boards shall be supported by an adequate number of supporting pins on the back with bend settings of 90 mm span 0.5 mm max.
- (2) Confirm that the measuring pins have the right tip shape, are equal in height, have the right pressure and are set in the correct positions. The following figures are for your reference to avoid bending the PC board.

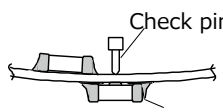
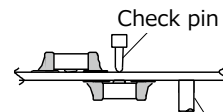
Item	Prohibited mounting	Recommended mounting
Bending of PC board	 <p>Separated, Crack</p>	 <p>Supporting pin</p>

8. Protective Coating

Make sure characteristics and reliability when using the resin coating or resin embedding for the purpose of improvement of humidity resistance or gas resistance, or fixing of parts because failures of a thermistors such as 1) ,2) and 3) may be occurred.

- (1) The solvent which contained in the resin permeate into the Varistors, and it may deteriorate the characteristic.

- (2) When hardening the resin, chemical reaction heat (curing heat generation) happen and it may occurs the infection to the Varistors.
- (3) The lead wire might be cut down and the soldering crack might be happen by expansion or contraction of resin hardening.

9. Dividing/Breaking of PC Boards

- (1) Please be careful not to stress the substrate with bending/twisting when dividing, after mounting components including Varistors. Abnormal and excessive mechanical stress such as bending or torsion shown below can cause cracking in the Varistors.

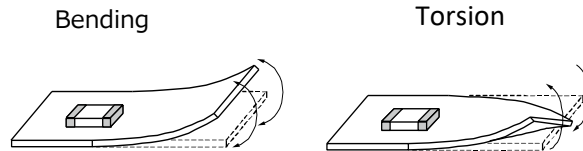

- (2) Dividing/Breaking of the PC boards shall be done carefully at moderate speed by using a jig or apparatus to prevent the Varistors on the boards from mechanical damage.
- (3) Examples of PCB dividing/breaking jigs: The outline of PC board breaking jig is shown below. When PC board are broken or divided, loading points should be close to the jig to minimize the extent of the bending. Also, planes with no parts mounted on should be used as plane of loading, in order to prevent tensile stress induced by the bending, which may cause cracks of the Varistors or other parts mounted on the PC boards.

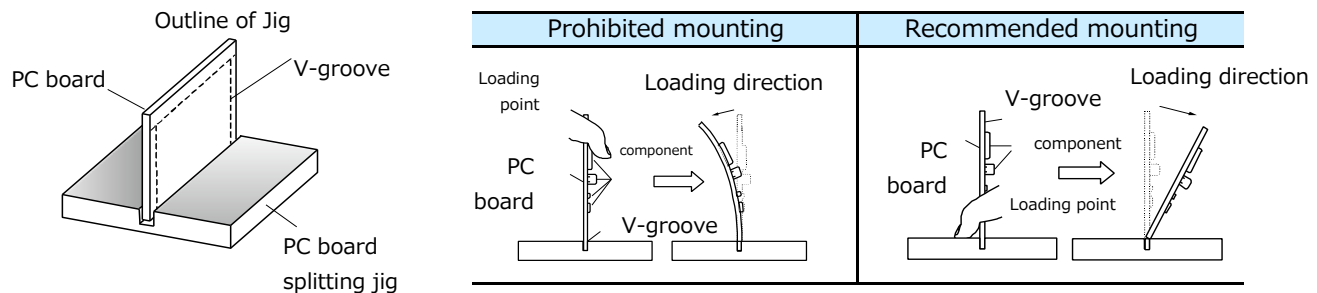

10. Mechanical Impact

- (1) The Varistors shall be free from any excessive mechanical impact. The Varistor body is made of ceramics and may be damaged or cracked if dropped. Never use a Varistor which has been dropped; their quality may already be impaired, and in that case, failure rate will increase.
- (2) When handling PC boards with Varistors mounted on them, do not allow the Varistors to collide with another PC board. When mounted PC boards are handled or stored in a stacked state, the corner of a PC board might strike Varistors, and the impact of the strike may cause damage or cracking and can deteriorate the withstand voltage and insulation resistance of the Varistor.

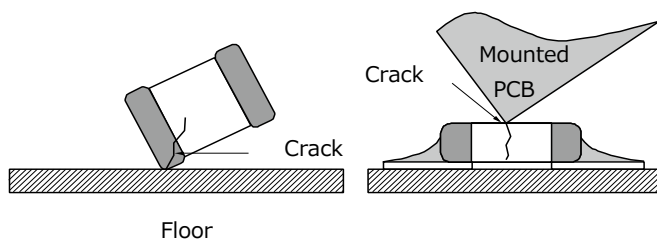

- 11.** Do not reuse this product after removal from the mounting board.

Precautions for discarding

As to the disposal of the Varistors, check the method of disposal in each country or region where the modules are incorporated in your products to be used.

Other

The various precautions described above are typical. For special mounting conditions, please contact us.

Applicable laws and regulations , others

1. This product not been manufactured with any ozone depleting chemical controlled under the Montreal Protocol.
2. This product comply with RoHS(Restriction of the use of certain Hazardous Substance in electrical and electronic equipment) (DIRECTIVE 2011/65/EU and 2015/863/EU).
3. All the materials used in this part are registered material under the Law Concerning the Examination and Regulation of Manufacture, etc. of Chemical Substance.
4. If you need the notice by letter of "A preliminary judgement on the Laws of Japan foreign exchange and Foreign Trade Control", be sure to let us know.
5. These products are not dangerous goods on the transportation as identified by UN (United nations) numbers or UN classification.
6. The technical information in this catalog provides example of our products' typical operations and application circuit. We do not guarantee the non-infringement of third party's intellectual property rights and we do not grant any license, Right or interest in our intellectual property.

单击下面可查看定价，库存，交付和生命周期等信息

[>>Panasonic\(松下\)](#)