

FEATURES

- ※Low profile for space saving
- ※Gold contact for high reliability
- ※Top tape type for washing process

APPLICATION

- ※Industrial control
- ※Automatic machines control
- ※Telecommunication

SPECIFICATION

Contact Rating	25mA, 24V DC
Contact Resistance	50mΩ max.
Insulation Resistance	100MΩ min. 500V DC
Dielectric Strength	500V AC/1 minute
Operating Force	1,000gf max.
Travel	1mm
Operating Life	2,000 cycles
Operating Temp.	-20°C ~ +85°C
Storage Temp.	-40°C ~ +85°C

HOW TO ORDER

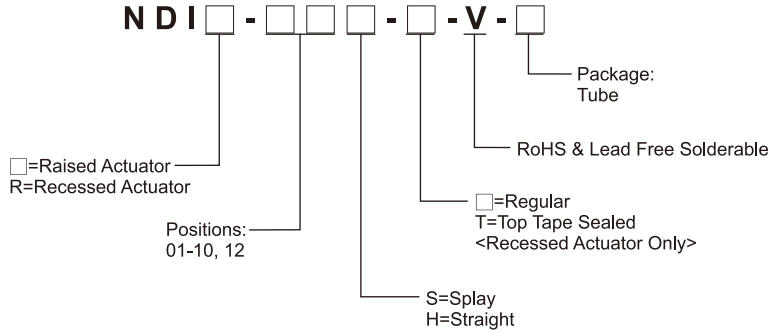

CIRCUIT

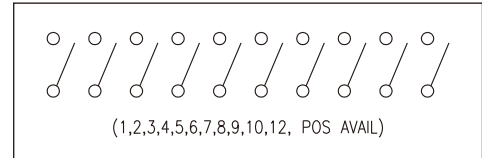

PACKAGE

- <Tube>**
- NDI(R)-01: 130 pcs
 - NDI(R)-02: 76 pcs
 - NDI(R)-03: 55 pcs
 - NDI(R)-04: 42 pcs
 - NDI(R)-05: 35 pcs
 - NDI(R)-06: 28 pcs
 - NDI(R)-07: 25 pcs
 - NDI(R)-08: 22 pcs
 - NDI(R)-09: 20 pcs
 - NDI(R)-10: 18 pcs
 - NDI(R)-12: 15 pcs

NDI(R)

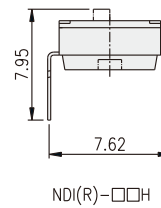
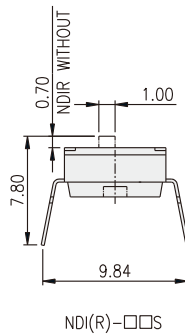
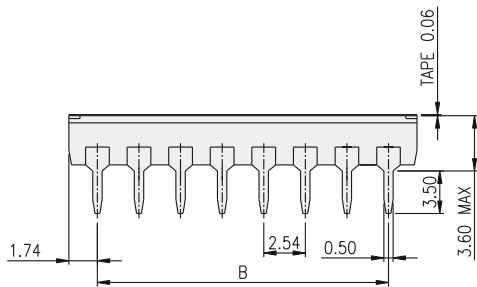
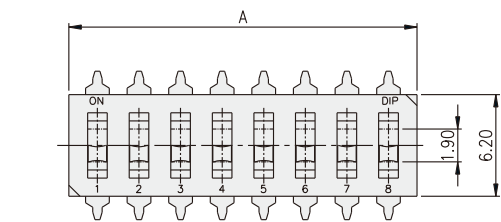

PART NO.	NO.OF POS.	DIM.A	DIM.B
NDI(R)-01	1	3.48	
NDI(R)-02	2	6.02	2.54
NDI(R)-03	3	8.56	5.08
NDI(R)-04	4	11.10	7.62
NDI(R)-05	5	13.64	10.16
NDI(R)-06	6	16.18	12.70
NDI(R)-07	7	18.72	15.24
NDI(R)-08	8	21.26	17.78
NDI(R)-09	9	23.80	20.32
NDI(R)-10	10	26.34	22.86
NDI(R)-12	12	31.42	27.94

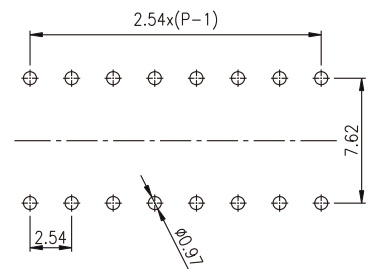

P.C.B. LAYOUT

单击下面可查看定价，库存，交付和生命周期等信息

[>>Diptronics\(圆达\)](#)