

# DIP SWITCH DHN(F) SERIES

1.6mm  
Half Pitch Type

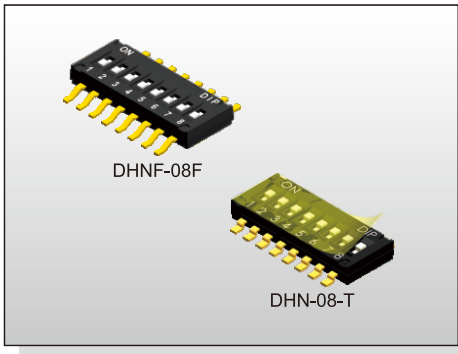

## FEATURES

- ※Low profile 1.6mm height
- ※Gold contact for high reliability
- ※Top tape type for washing process

## APPLICATION

- ※Industrial control
- ※Automatic machines control
- ※NB, electronic devices

## SPECIFICATION

|                       |                    |
|-----------------------|--------------------|
| Contact Rating        | 25mA, 24V DC       |
| Contact Resistance    | 100mΩ max.         |
| Insulation Resistance | 100MΩ min. 500V DC |
| Dielectric Strength   | 300V AC/1 minute   |
| Operating Force       | 500gf max.         |
| Travel                | 0.6mm              |
| Operating Life        | 1,000 cycles       |
| Operating Temp.       | -40°C ~ +85°C      |
| Storage Temp.         | -40°C ~ +85°C      |

## HOW TO ORDER

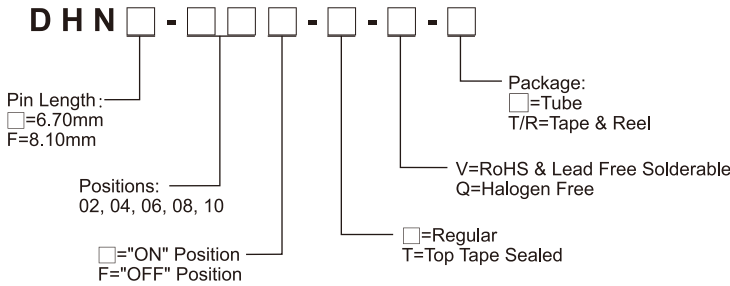

## CIRCUIT

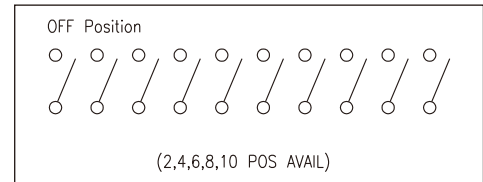

## PACKAGE

- <Tube>  
 DHN(F)-02: 125 pcs  
 DHN(F)-04: 75 pcs  
 DHN(F)-06: 54 pcs  
 DHN(F)-08: 40 pcs  
 DHN(F)-10: 33 pcs
- <Tape & Reel>  
 DHN: 4000 pcs  
 DHNF: 2500 pcs

## DHN

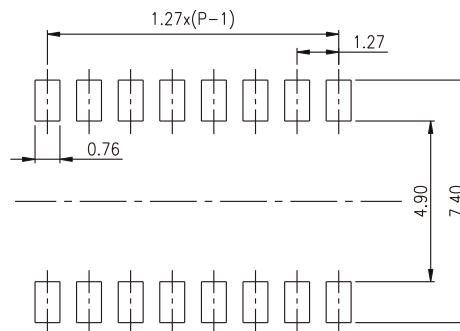
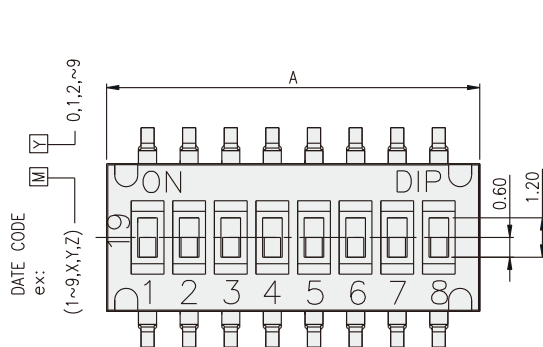

P.C.B. LAYOUT

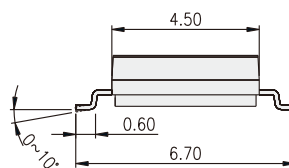
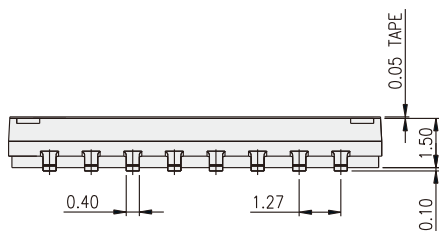

| PART NO. | NO.OF POS | DIM A |
|----------|-----------|-------|
| DHN-02   | 2         | 3.77  |
| DHN-04   | 4         | 6.31  |
| DHN-06   | 6         | 8.85  |
| DHN-08   | 8         | 11.39 |
| DHN-10   | 10        | 13.93 |

DHNF

DIP SWITCH

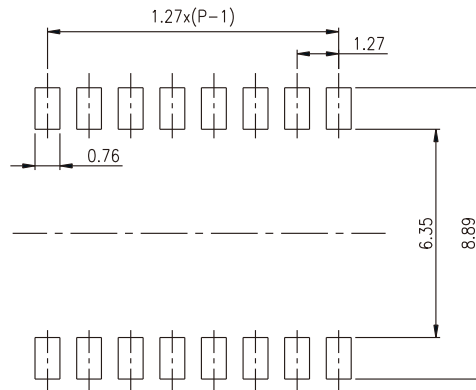
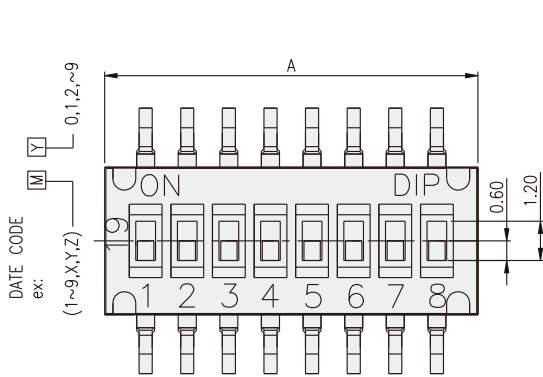

P.C.B. LAYOUT

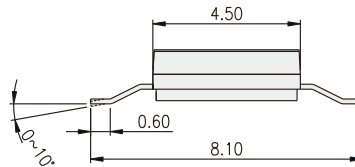
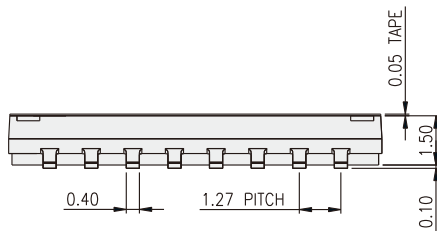

| PART NO. | NO.OF POS | DIM A |
|----------|-----------|-------|
| DHNF-02  | 2         | 3.77  |
| DHNF-04  | 4         | 6.31  |
| DHNF-06  | 6         | 8.85  |
| DHNF-08  | 8         | 11.39 |
| DHNF-10  | 10        | 13.93 |

单击下面可查看定价，库存，交付和生命周期等信息

[>>Diptronics\(圆达\)](#)