

**FEATURES**

- ※Side actuation
- ※Wide stem for easy operation
- ※Gold contact for high reliability

**APPLICATION**

- ※Industrial control
- ※Automatic machines control
- ※Telecommunication

**SPECIFICATION**

Contact Rating	25mA, 24V DC
Contact Resistance	100mΩ max.
Insulation Resistance	100MΩ min. 500V DC
Dielectric Strength	500V AC/1 minute
Operating Force	800gf max.
Travel	1mm
Operating Life	2,000 cycles
Operating Temp.	-20°C ~ +85°C
Storage Temp.	-40°C ~ +85°C

**HOW TO ORDER**

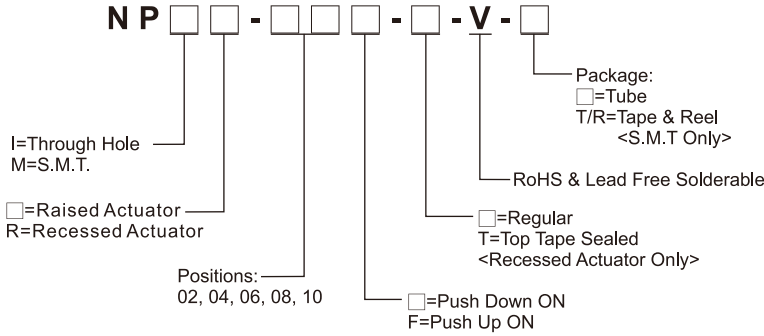

**CIRCUIT**

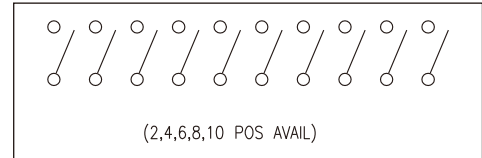

**PACKAGE**

- <Tube>  
 NPI(R)/NPM(R)-02: 70 pcs  
 NPI(R)/NPM(R)-04: 40 pcs  
 NPI(R)/NPM(R)-06: 28 pcs  
 NPI(R)/NPM(R)-08: 20 pcs  
 NPI(R)/NPM(R)-10: 16 pcs
- <Tape & Reel>  
 NPM(R)-02, 04, 06, 08, 10: 700 pcs

**NPI**

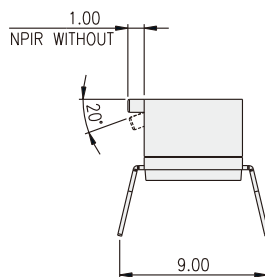
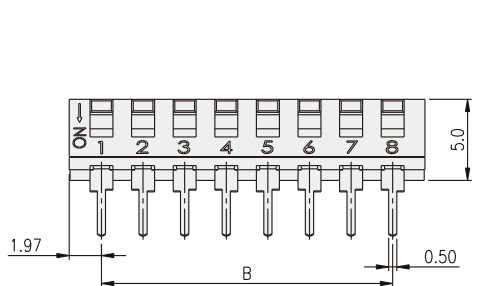
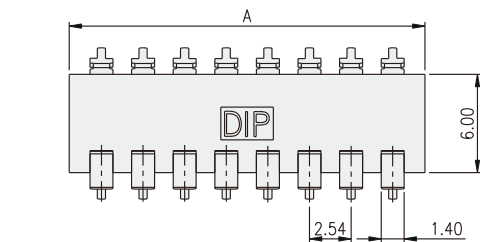

PART NO.	NO.OF POS.	DIM.A	DIM.B
NPI(R)-02	2	6.48	2.54
NPI(R)-04	4	11.56	7.62
NPI(R)-06	6	16.64	12.70
NPI(R)-08	8	21.72	17.78
NPI(R)-10	10	26.80	22.86

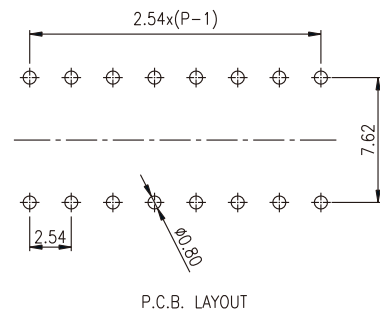

NPM

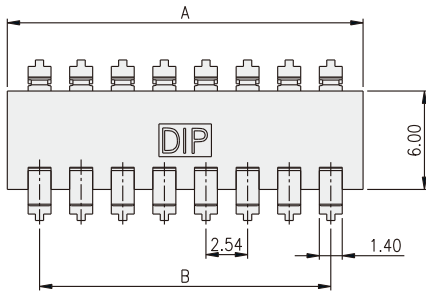

PART NO.	NO.OF POS.	DIM.A	DIM.B
NPM(R)-02	2	6.48	2.54
NPM(R)-04	4	11.56	7.62
NPM(R)-06	6	16.64	12.70
NPM(R)-08	8	21.72	17.78
NPM(R)-10	10	26.80	22.86

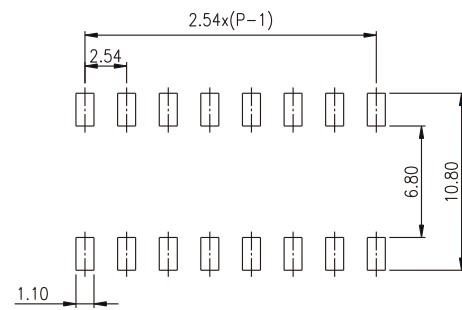
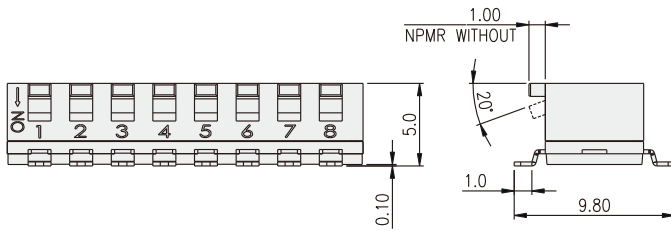

P.C.B. LAYOUT

DIP SWITCH

单击下面可查看定价，库存，交付和生命周期等信息

[>>Diptronics\(圆达\)](#)