

LMBR220FT1G thru LMBR2200FT1G

Schottky Barrier Rectifiers

Reverse Voltage 20 to 200V Forward Current 2.0A

FEATURES

- * Plastic package has Underwriters Laboratory Flammability Classification 94V-0
- * Low power loss, high efficiency
- * For use in low voltage high frequency inverters, free wheeling, and polarity protection applications
- * Guardring for over voltage protection
- * High temperature soldering guaranteed: 260°C/10 seconds at terminals

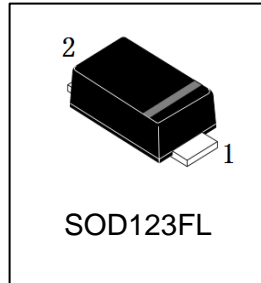

Mechanical Data

Case: SOD123-FL/MINI SMA

molded plastic over sky die

Terminals: Plated leads, solderable per MIL-STD-750, Method 2026

Polarity: Color band denotes cathode end

Mounting Position: Any

Weight: 0.0155 g

Handling precaution: None



We declare that the material of product is Halogen free (green epoxy compound)

1. Electrical Characteristic

Maximum & Thermal Characteristics Ratings at 25°C ambient temperature unless otherwise specified.

Parameter Symbol	symbol	LMBR 220FT1G	LMBR 230FT1G	LMBR 240FT1G	LMBR 250FT1G	LMBR 260FT1G	LMBR 280FT1G	LMBR 2100FT1G	LMBR 2150FT1G	LMBR 2200FT1G	Unit
device marking code		22	23	24	25	26	28	210	215	220	
Maximum repetitive peak reverse voltage	V_{RRM}	20	30	40	50	60	80	100	150	200	V
Maximum RMS voltage	V_{RMS}	14	21	28	35	42	56	70	105	140	V
Maximum DC blocking voltage	V_{DC}	20	30	40	50	60	80	100	150	200	V
Maximum average forward rectified current at $T_C = 75^\circ C$	$I_{F(AV)}$	2.0									A
Peak forward surge current 8.3ms single half sine-wave superimposed on rated load (JEDEC Method)	I_{FSM}	50									A
Typical thermal resistance (Note 1)	$R_{\theta JA}$	170									°C/W
Operating junction temperature range	T_J	-55 to +150									°C
storage temperature range	T_{STG}	-65 to +175									°C

Electrical Characteristics Ratings at 25°C ambient temperature unless otherwise specified.

Parameter Symbol	symbol	LMBR 220FT1G	LMBR 230FT1G	LMBR 240FT1G	LMBR 250FT1G	LMBR 260FT1G	LMBR 280FT1G	LMBR 2100FT1G	LMBR 2150FT1G	LMBR 2200FT1G	Unit
Maximum instantaneous forward voltage at 2.0A	V_F	0.50			0.70		0.85		0.9	0.92	V
Maximum DC reverse current at rated DC blocking voltage $T_A = 25^\circ C$ $T_j = 100^\circ C$	I_R	0.5 20									mA
Typical junction capacitance at 4.0V, 1MHz	C_J	160									PF

NOTES:

1. 8.0mm² (.013mm thick) land areas

LMBR220FT1G thru LMBR2200FT1G

2. Ratings and Characteristic Curves (TA = 25°C unless otherwise noted)

Fig. 1 - Forward Current Derating Curve

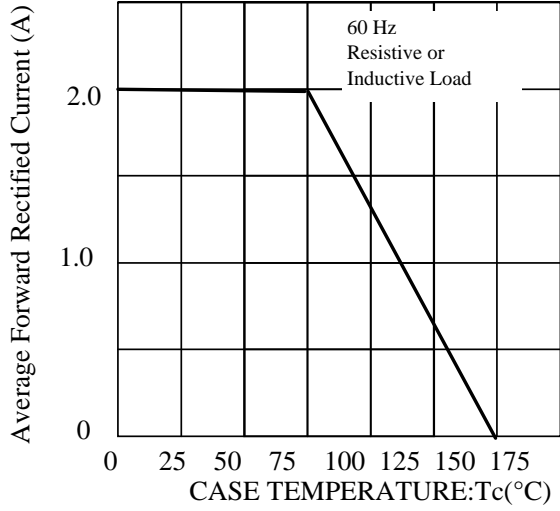

Fig. 2 - Maximum Non-repetitive Peak Forward Surge Current

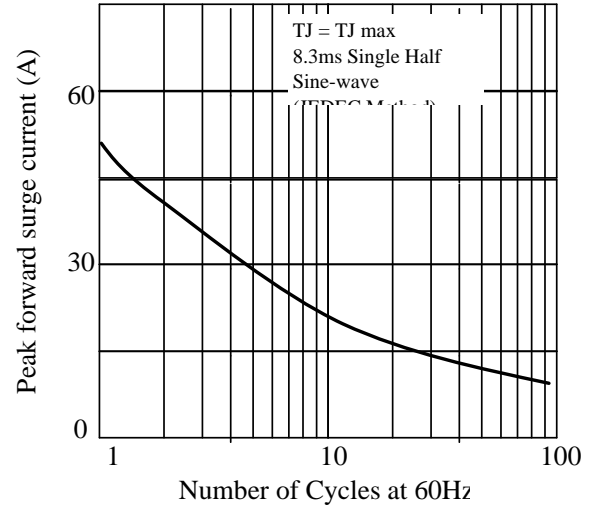

Fig 3. - Typical Instantaneous Forward Characteristics

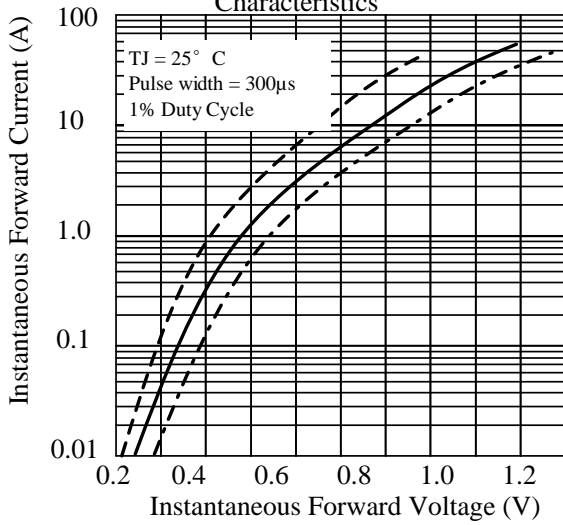

Fig 4. - Typical Reverse Characteristics

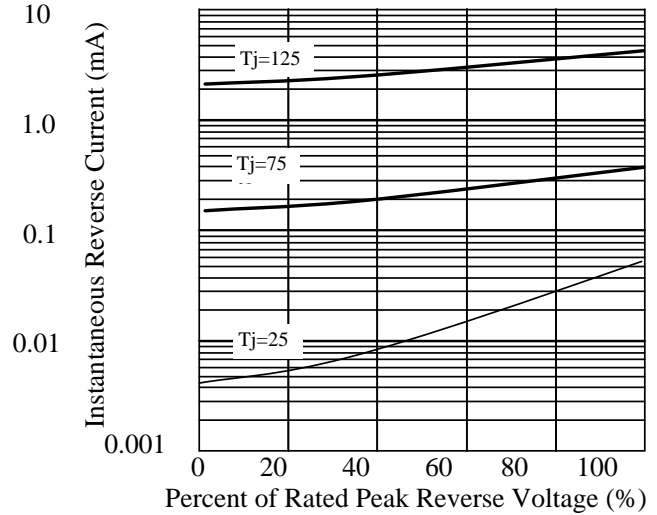

Fig 5. - typical transient thermal impedance

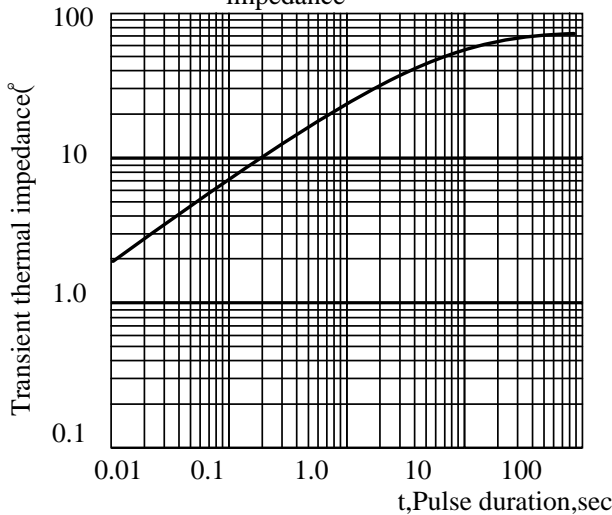
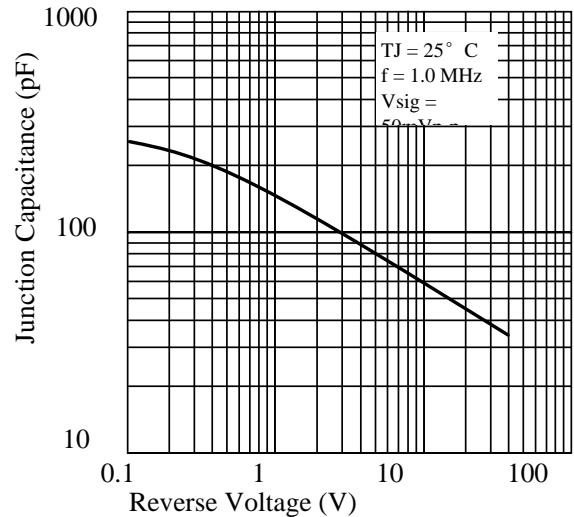
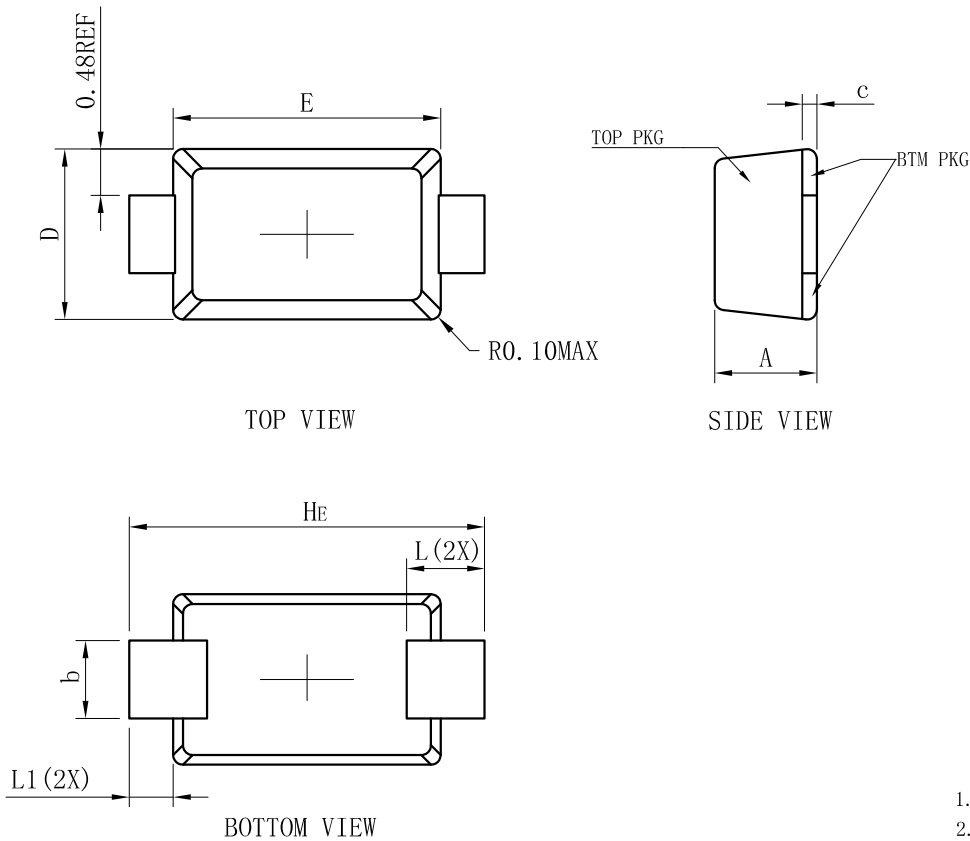

Fig 6. - Typical Junction Capacitance



3.OUTLINE AND DIMENSIONS



SOD123FL			
DIM	MIN	NOR	MAX
A	0.90	1.05	1.15
b	0.75	0.80	0.95
L	0.80REF.		
E	2.60	2.75	2.90
D	1.60	1.75	1.90
HE	3.50	3.65	3.80
c	0.12	0.17	0.22
L1	0.45REF.		
All Dimensions in mm			

GENERAL NOTES

- 1.Top package surface finish $Ra0.4\pm0.2\mu\text{m}$
- 2.Bottom package surface finish $Ra0.7\pm0.2\mu\text{m}$
- 3.Side package surface finish $Ra0.4\pm0.2\mu\text{m}$

4.SOLDERING FOOTPRINT

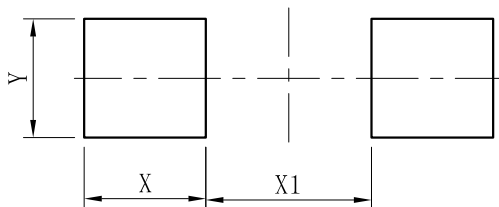

DIM	(mm)
X	1.20
Y	1.10
X1	2.00

LMBR220FT1G thru LMBR2200FT1G

5. Suggested thermal profile for soldering process

1. Storage environment : Temperature=5~40°C Humidity=55±25%
2. Reflow soldering of surface-mount device

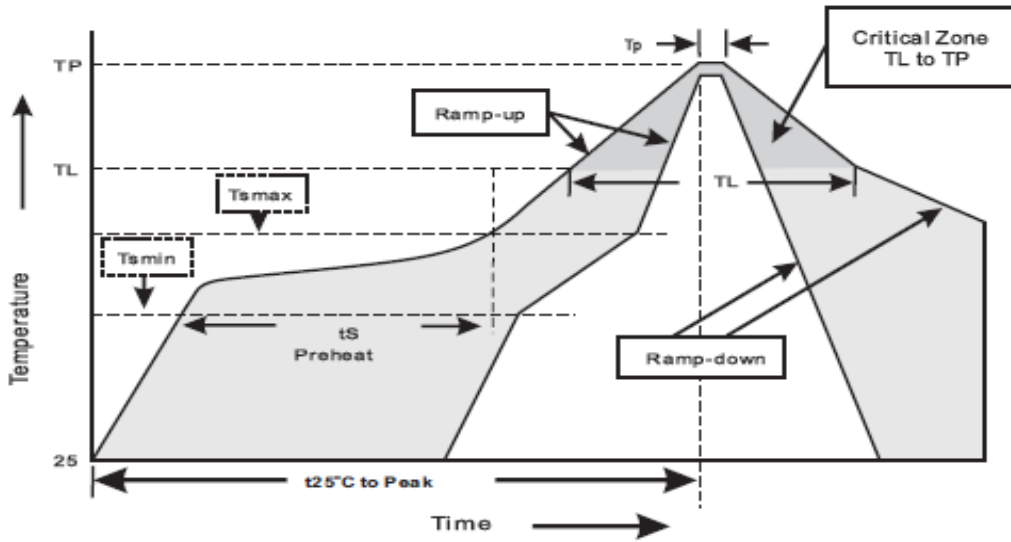

3. Reflow soldering

Profile Feature	Soldering Condition
Average ramp-up rate(T _L to T _P)	<3°C/sec
Preheat	
- Temperature Min(T _{Amin})	150°C
- Temperature Max(T _{smax})	200°C
- Time(min to max)(t _s)	60~120sec
T _{smax} to T _L	
- Ramp-up Rate	<3sec
Time maintained above:	
- Temperature (T _L)	217°C
- Time(t _L)	60-260sec
Peak Temperature(T _P)	255 -0/+5°C
Time within 5°C of actual Peak Temperature(T _P)	10~30sec
Ramp-down Rate	<6°C/sec
Time 25°C to Peak Temperature	<6minutes

LMBR220FT1G thru LMBR2200FT1G

6.High reliability test capabilities

Item Test	Condition	Reference
Solder Resistance	at 260±5°C for 10±2sec immerse body into solder 1/16" ± 1/32"	MIL-STD-750D METHOD-2031
Solderability	at 245±5°C for 5 sec	MIL-STD-202F METHOD-208
High Temperature Reverse Bias	V _R =80% rate at T _j =150°C for 168hrs	MIL-STD-750D METHOD-1038
Forward Operation Life	Rated average rectifier current T _A =25°C for 500hrs	MIL-STD-750D METHOD-1027
Intermittent Operation Life	T _A =25°C , I _F =I _o On state:power on for 5 min. Off state:power off for 5 min. on and off for 500 cycles	MIL-STD-750D METHOD-1036
Pressure Cooker	15P _{SIG} at T _A =121°C for 4hrs	JESD22-A102
Temperature Cycling	-55°C to +125°C dwelled for 30 min. and transferred for 5min. Total 10 cycles	MIL-STD-750D METHOD-1051
Thermal Shock	0°C for 5min. Rise to 100°C for 5min. Total 10 cycles	MIL-STD-750D METHOD-1056
Forward Surge	8.3ms single half sine-wave superimposed on rated load,one surge	MIL-STD-750D METHOD-4066-2
Humidity	at T _A =85°C , RH=85% for 1000hrs	MIL-STD-750D METHOD-1021
High Temperature Storage Life	at 175°C for 1000hrs	MIL-STD-750D METHOD-1031



Proprietary Information

Title: Power Packages Product Packing Specification

功率产品包装规范

Document Number: APS-QA-QS-009

Revision C

Page 3 of 6



8.1.2 Label position and QA stamp position.(Empty area) 标签张贴位置及QA印章位置。(印章盖在标签空白区)



7英寸卷盘标签张贴及QA印章位置

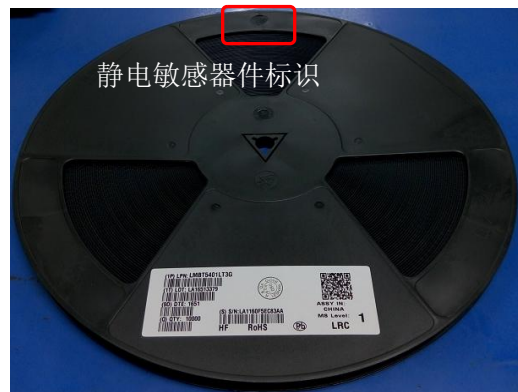

13英寸卷盘标签张贴及QA印章位置

8.1.3 Ensure direction In the same reel. The same steel coil plate direction, With antistatic bubble to package reel. Refer to the below picture.

同一箱内的卷盘方向一致,用防静电泡沫对卷盘进行包裹。



7英寸卷盘防静电泡沫包裹



13英寸卷盘防静电泡沫包裹

Do not copy without written permission from Advanced Power Semiconductor



Proprietary Information

Title: Power Packages Product Packing Specification

功率产品包装规范

Document Number: APS-QA-QS-009

Revision C

Page 4 of 6

8.1.4 Put in the antistatic packing box after packaged reels. And QA stamp on the box label .

将包装好的卷盘放入防静电纸箱中，并在盒标签上盖章。



7 英寸卷盘内盒及标签



13 英寸卷盘内盒及标签

8.1.5 Product use printing inner box. 产品使用LRC印字内箱。



7英寸卷盘内箱印字（侧面）



13英寸卷盘内箱印字（正面）

8.1.6 Inner box packing quantity requirement. 内盒包装数量要求。

Product Description	QTY
SOD123-FL	1-10Reels
SOD323-HE	1-10Reels
SMA-FL	1-7Reels
SMB-FL	1-4Reels

8.1.7 With transparent tape sealing. 透明胶带封箱。

Do not copy without written permission from Advanced Power Semiconductor



Proprietary Information

Title: Power Packages Product Packing Specification

功率产品包装规范

Document Number: APS-QA-QS-009

Revision C

Page 5 of 6



7英寸内箱封盒



13英寸内箱封盒

8.1.8 Outer box size and packing quantity requirement, 外箱尺寸及包装数量要求。

Product Description	卷盘尺寸	Height (H)	Width (W)	Length (L)	Max. Qty
Power Device	7 英寸	410mm	400mm	445mm	12
Power Device	13 英寸	410mm	400mm	445mm	5



7 英寸卷盘产品装箱



13 英寸卷盘产品装箱

统一方向

Do not copy without written permission from Advanced Power Semiconductor



Proprietary Information

Title: Power Packages Marking & Taping Specification

功率封装字模和编带规范

Document Number: APS-QA-QS-010

Revision C

Page 6 of 9

8.2 Standard Products Taping Specification

标准产品编带规范

8.2.1 Tape length of no component

空带长度说明

Taping leader length 引导部分: $440\text{mm} \pm 40\text{mm}$, Tape trailer 尾部: $200\text{mm} \pm 40\text{mm}$

Figure 4

Tape Ends For Finished Goods Reel

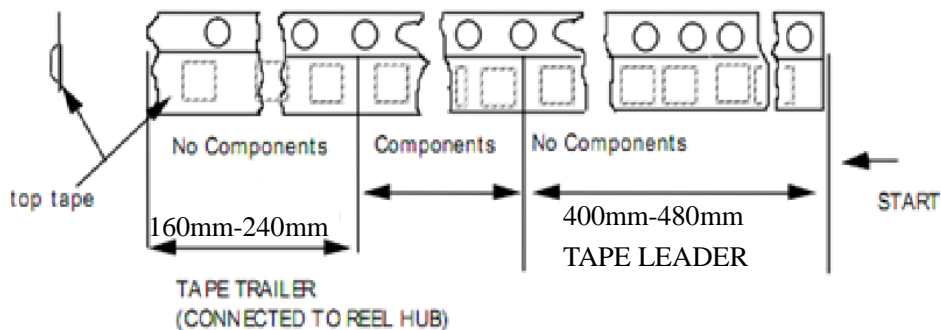

8.2.2 Component packaging orientation: The cathode lead is close to the carrier tape's index hole.

产品放置方向: 印阴极带引脚邻近载带索引孔



Do not copy without written permission from Advanced Power Semiconductor



Proprietary Information

Title: Power Packages Marking & Taping Specification

功率封装字模和编带规范

Document Number: APS-QA-QS-010

Revision C

Page 7 of 9

8.2.3 Tape enwind orientation

编带缠绕方向要求



Do not copy without written permission from Advanced Power Semiconductor

单击下面可查看定价，库存，交付和生命周期等信息

[>>LRC\(乐山无线电\)](#)