

Feature

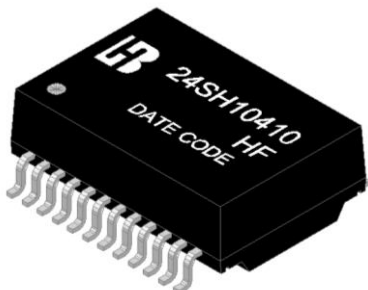

- Designed for long haul gigabit Ethernet 1000 BASE-T, full duplex applications.
- Supports 4 pairs of category 5 UTP cable.
- Cable interface for isolation and low common mode emissions.
- Complying with IEEE 802.3ab standard for 1000 BASE-T.
- Complying with IEEE 802.3af standard.
- Complying with ROHS & Halogen Free requirements.
- Operating temperature range: -10°C to +70°C.
- Storage temperature range: -25°C to +85°C.

Electrical Specifications @ 25°C							
Part Number	Turns Ratio (±5%)		OCL (uH Min) @100KHz/0.1V with 8mA DC Bias	L.L (uH Max)	C _{ww} (pF Max)	DCR (Ω Max)	HI-POT
	TX	RX					
24SH10410 HF	1CT:1CT	1CT:1CT	350	0.5	28	1.1	AC5000V /1mA /2S

Continue						
Part Number	Insertion Loss (dB Max)	Return Loss (dB Min)@Load 100Ω				
		1-100MHz	1-30MHz	40MHz	50MHz	60-80MHz
24SH10410 HF	-1.0	-18	-16	-14.08	-12.5	-10

Continue						
Part Number	Cross talk (dB Min)			DCMR (dB Min)		
	30MHz	60MHz	100MHz	30MHz	60MHz	100MHz
24SH10410 HF	-45	-40	-35	-43	-37	-33

Schematic

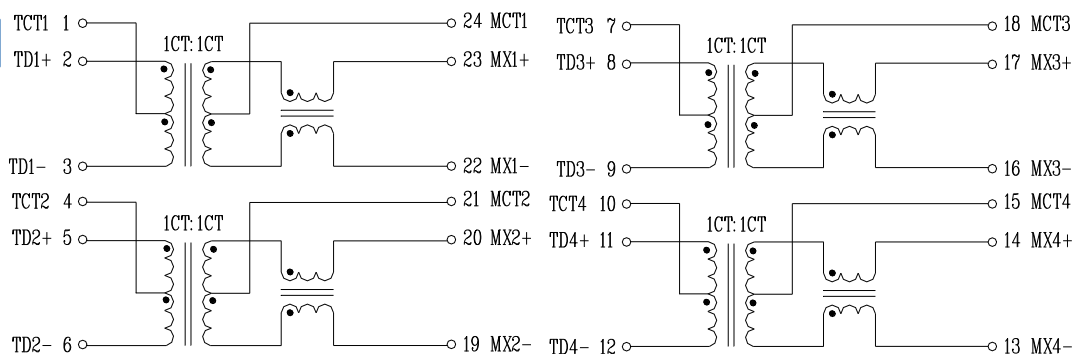

24SH10410 HF
SMD 1000 BASE-T Single Port Discrete
LAN Magnetics



Mechanical

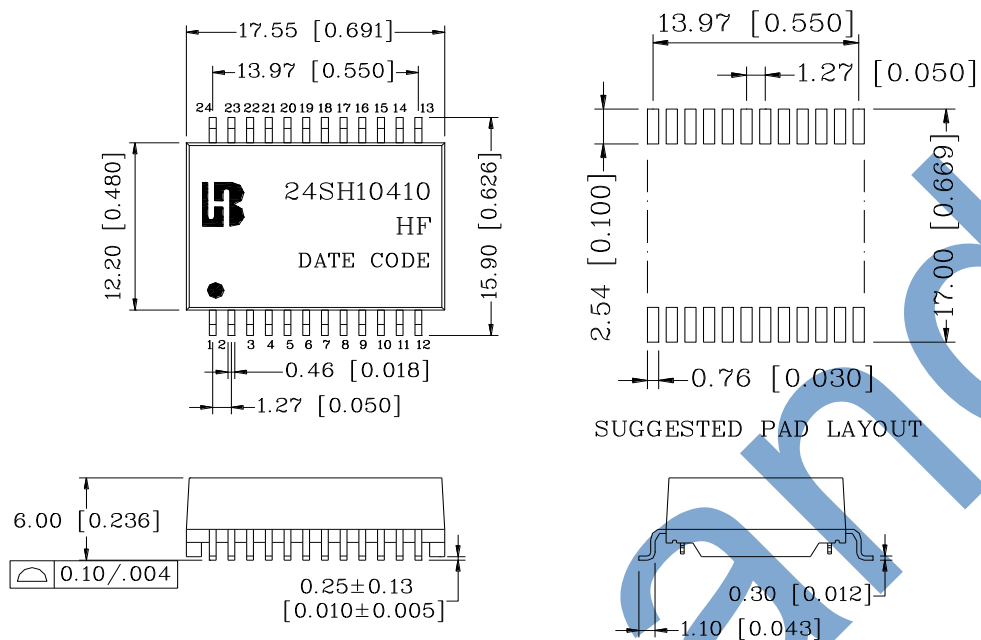

Units: mm[Inches] Tolerances: xx.xx±0.25[0.010]
 0.xx±0.05[0.002]

24SH10410 HF
SMD 1000 BASE-T Single Port Discrete
LAN Magnetics

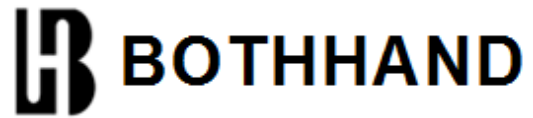

REEL PACKAGE

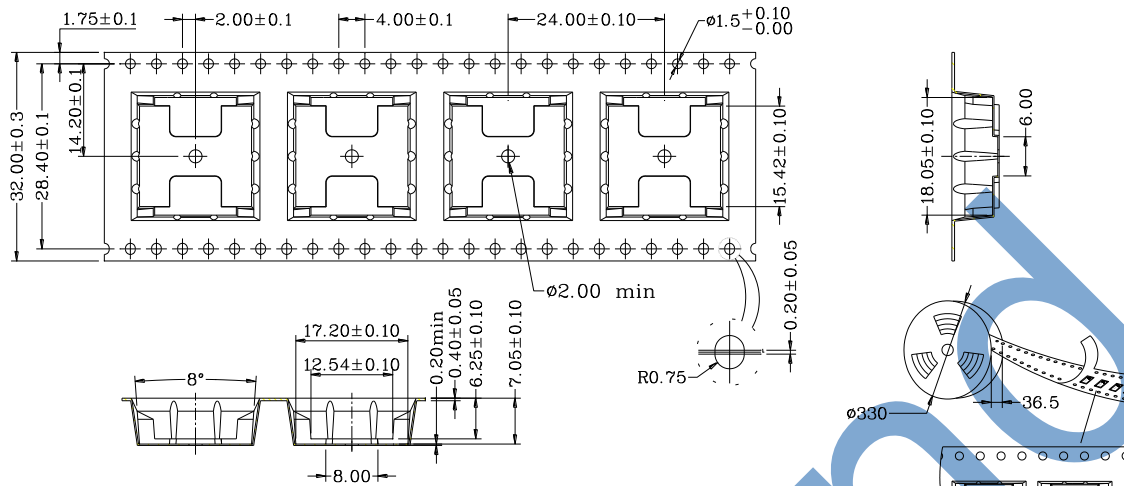

1. 10 sprocket hole pitch cumulative tolerance ± 0.20
2. Material :Black Anti-Static polystyrene.
3. All dimensions meet EIA-481-3 requirements
4. Thickness : 0.40 ± 0.05 mm
5. Component load per 13" reel :350 pcs
6. Carrier camber is within 1 mm in 250 mm
7. Packing length per 22 reel :29 Meters
8. Comply with Bothhand's <BHKP-WI-44-005> requirements

CARTON PACKAGE

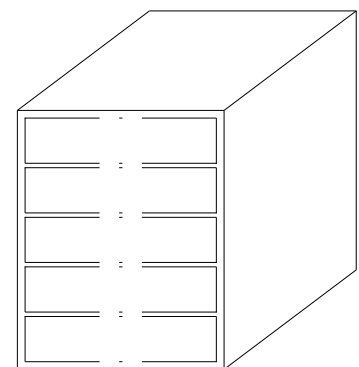
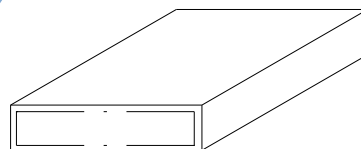
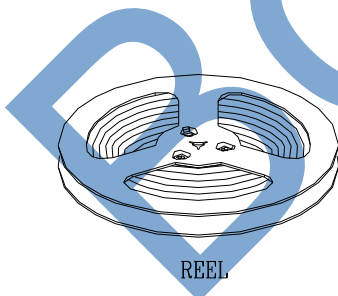

1. 1 Reel=350PCS
2. 1 INNER BOX=1 Reel=350PCS
3. 1 OUTER CARTON=5 INNER BOX=5x350=1750PCS

单击下面可查看定价，库存，交付和生命周期等信息

[>>Bothhand\(帛汉\(帛漠\)\)](#)