

# APPROVAL SHEET

**WA04Y**

**$\pm 5\%$ ,  $\pm 1\%$  Convex Type**

Thick film general purpose chip resistors  
array

Size 0402x2

\*Contents in this sheet are subject to change without prior notice.

## FEATURE

1. Small size and light weight
2. Reduced size of final equipment
3. Lower surface mounted assembly costs
4. Higher component and equipment reliability
5. RoHS compliant and lead free

## APPLICATION

- Consumer electrical equipment, PDA, Digital Cam-coder, ...
- EDP, Computer application
- Mobile phone, Telecom

## DESCRIPTION

The resistors array is constructed in a high grade ceramic body (aluminum oxide). Internal metal electrodes are added at each end and connected by a resistive paste that is applied to the top surface of the substrate. The composition of the paste is adjusted to give the approximate resistance required and the value is trimmed to within tolerance by laser cutting of this resistive layer.

The resistive layer is covered with a protective coat. Finally, the two external end terminations are added. For ease of soldering the outer layer of these end terminations is a Tin (lead free) solder alloy.

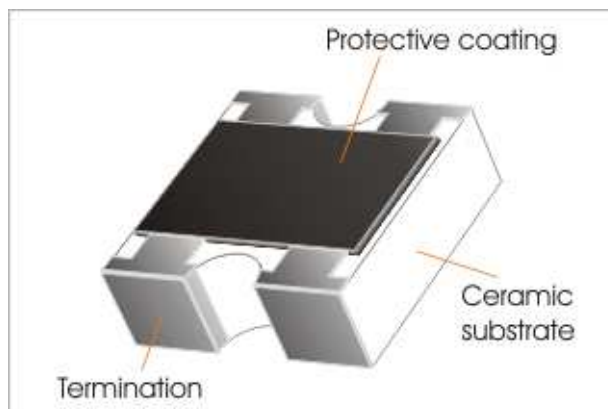

Fig 1. Outline of chip-R array WA04Y

**QUICK REFERENCE DATA**

Item	General Specification
Series No.	WA04Y(Convex)
Size	0402x2 (1005x2)
Resistance Tolerance	±5% , ±1%
Resistance Range	±5%: 3Ω ~ 1MΩ, Jumper ±1%: 10Ω ~ 1MΩ
TCR (ppm/°C) 10Ω≤R≤1MΩ R<10Ω	≤ ± 200 ppm/°C ≤ ± 400 ppm/°C
Max. dissipation at T <sub>amb</sub> =70°C	1/16 W
Max. Operation Voltage (DC or RMS)	25V
Max. overload voltage	50V
Climatic category	55/155/56

Note :

1. This is the maximum voltage that may be continuously supplied to the resistor element, see "IEC publication 60115-8"
2. Max. Operation Voltage : So called RCWV (Rated Continuous Working Voltage) is determined by

$$RCWV = \sqrt{\text{Rated Power} \times \text{Resistance Value}} \text{ or Max. RCWV listed above, whichever is lower.}$$

**DIMENSIONS(unit : mm)**

	WA04Y
<b>L</b>	1.00 ± 0.10
<b>W</b>	1.00 ± 0.10
<b>T</b>	0.35 ± 0.10
<b>P</b>	0.65 ± 0.10
<b>A</b>	0.34 ± 0.10
<b>Ta</b>	0.20 ± 0.15
<b>Tb</b>	0.25 ± 0.17

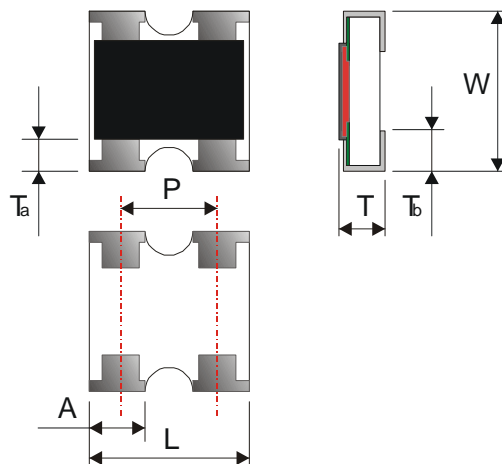

## MARKING

*No marking for WA04Y chip resistors array*

## FUNCTIONAL DESCRIPTION

### Product characterization

Standard values of nominal resistance are taken from the E24 series for resistors with a tolerance of  $\pm 5\%$ ,  $\pm 1\%$ . The values of the E24 series are in accordance with "IEC publication 60063"

### Derating

The power that the resistor can dissipate depends on the operating temperature; see Fig.2

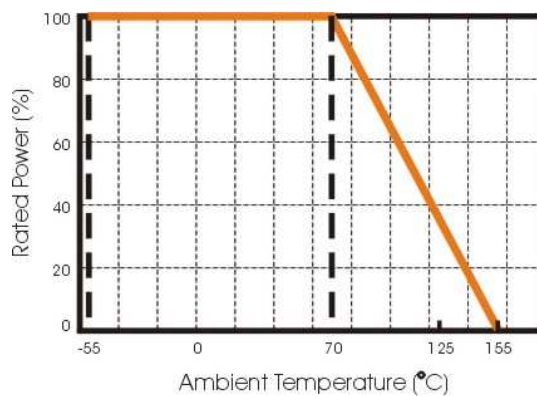
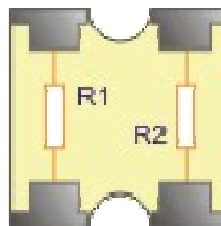

Figure 2. Maximum dissipation in percentage of rated power  
As a function of the ambient temperature

## CONSTRUCTION



R1=R2

## MOUNTING

Due to their rectangular shapes and small tolerances, Surface Mountable Resistors are suitable for handling by automatic placement systems.

Chip placement can be on ceramic substrates and printed-circuit boards (PCBs).

Electrical connection to the circuit is by individual soldering condition.

The end terminations guarantee a reliable contact.

### SOLDERING CONDITION

The robust construction of chip resistors allows them to be completely immersed in a solder bath of 260°C for 10 seconds. Therefore, it is possible to mount Surface Mount Resistors on one side of a PCB and other discrete components on the reverse (mixed PCBs).

Surface Mount Resistors are tested for solderability at 235°C during 2 seconds. The test condition for no leaching is 260°C for 30 seconds. Typical examples of soldering processes that provide reliable joints without any damage are given in Fig 3.

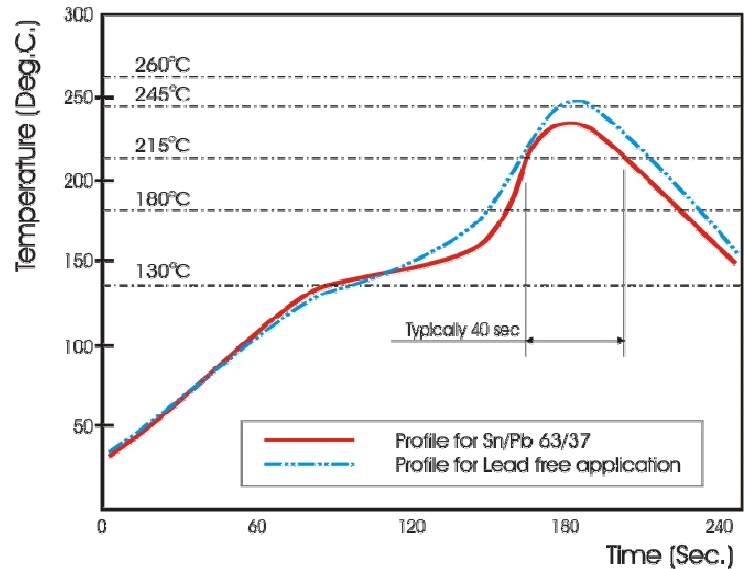

Fig 3. Infrared soldering profile for Chip Resistors array

### TEST CONDITION FOR JUMPER (0 Ω)

Item	WA04Y
Power Rating At 70°C	1/16W
Resistance	MAX.50mΩ
Rated Current	1A
Peak Current	1.5A
Operating Temperature	-55~155°C

### CATALOGUE NUMBERS

The resistors have a catalogue number starting with .

WA04	Y	472_	J	T	L
<b>Size code</b> WA04 : 0402	<b>Type code</b> Y : x2, convex	<b>Resistance code</b> E24 : 2 significant digits followed by no. of zeros and a blank  4.7Ω =4R7_ 10Ω =100_ 220Ω =221_ Jumper =000_ ("_" means a blank)	<b>Tolerance</b> F : ±1% J : ±5% P : Jumper	<b>Packaging code</b> T : 7" Reel taping Q : 10" reel taping G : 13" reel taping	<b>Termination code</b> L = Sn base (lead free)

Reeled tape packaging : 8mm width paper taping 10,000pcs per 7" reel.  
8mm width paper taping 20,000pcs per 10" reel.  
8mm width paper taping 40,000pcs per 13" reel.

**TEST AND REQUIREMENTS(JIS C 5201-1 : 1998)**

TEST	PROCEDURE	REQUIREMENT	
		Resistor	Jumper
DC resistance <b>Clause 4.5</b>	DC resistance values measured at the test voltages specified below : <10Ω@0.1V, <100Ω@0.3V, <1KΩ@1.0V, <10KΩ@3V, <100KΩ@10V, <1MΩ@25V, <10MΩ@30V	Within the specified tolerance	< 50mΩ
Temperature Coefficient of Resistance (T.C.R) <b>Clause 4.8</b>	Natural resistance change per change in degree centigrade. $\frac{R_2 - R_1}{R_1(t_2 - t_1)} \times 10^6 \text{ (ppm/}^\circ\text{C)}$ $t_1 : 20^\circ\text{C}+5^\circ\text{C}-1^\circ\text{C}$ R <sub>1</sub> : Resistance at reference temperature R <sub>2</sub> : Resistance at test temperature	Refer to "QUICK REFERENCE DATA"	N/a
Short time overload (S.T.O.L) <b>Clause 4.13</b>	Permanent resistance change after a 5second application of a voltage 2.5 times RCWV or the maximum overload voltage specified in the above list, whichever is less.	ΔR/R max. ±(2%+0.10Ω)	< 50mΩ
Resistance to soldering heat(R.S.H) <b>Clause 4.18</b>	Un-mounted chips completely immersed for 10±1second in a SAC solder bath at 260°C±5°C	Δ R/R max. ±(1%+0.05Ω) no visible damage	< 50mΩ
Solderability <b>Clause 4.17</b>	Un-mounted chips completely immersed for 2±0.5second in a SAC solder bath at 235°C±5°C	good tinning (>95% covered) no visible damage	
Temperature cycling <b>Clause 4.19</b>	30 minutes at -55°C±3°C, 2~3 minutes at 20°C+5°C-1°C, 30 minutes at +155°C±3°C, 2~3 minutes at 20°C+5°C-1°C, total 5 continuous cycles	Δ R/R max. ±(1%+0.05Ω) no visible damage	< 50mΩ
Load life (endurance) <b>Clause 4.25</b>	1000 +48/-0 hours, loaded with RCWV or Vmax in chamber controller 70±2°C, 1.5 hours on and 0.5 hours off	Δ R/R max.±(3%+0.10Ω) For 10Ω≤R<1MΩ ; Δ R/R max.±(5%+0.10Ω) For R<10Ω, R≥1MΩ	< 50mΩ
Load life in Humidity <b>Clause 4.24</b>	1000 +48/-0 hours, loaded with RCWV or Vmax in humidity chamber controller at 40°C±2°C and 90~95% relative humidity, 1.5hours on and 0.5 hours off	Δ R/R max.±(3%+0.10Ω) For 10Ω≤R<1MΩ ; Δ R/R max.±(5%+0.10Ω) For R<10Ω, R≥1MΩ	< 50mΩ
Adhesion <b>Clause 4.32</b>	Pressurizing force: 5N, Test time: 10±1sec.	No remarkable damage or removal of the terminations.	
Insulation Resistance <b>Clause 4.6</b>	Apply the maximum overload voltage (DC) for 1minutes	R ≥ 10GΩ	
Dielectric Withstand Voltage <b>Clause 4.7</b>	Apply the maximum overload voltage (AC) for 1 minutes	No breakdown or flashover	

**PACKAGING**

Paper Tape specifications (unit :mm)

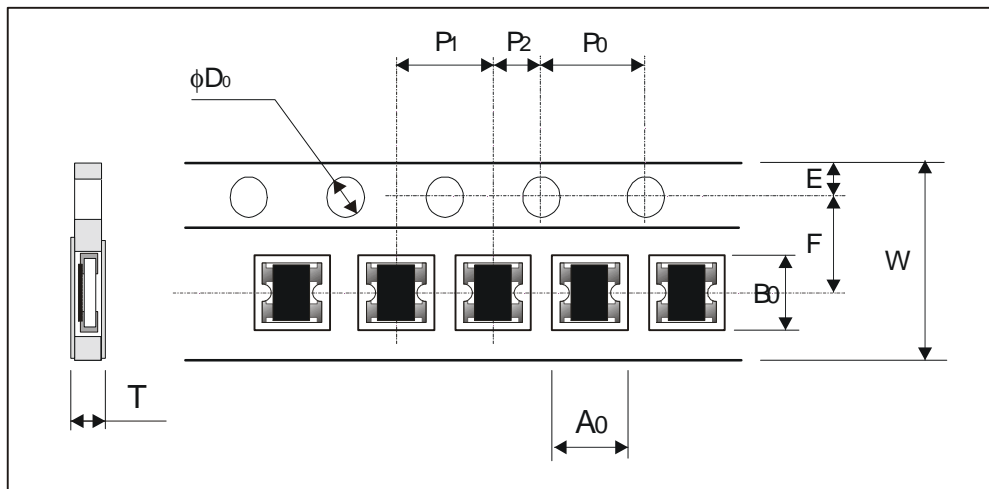

Symbol	A0	B0	W	F	E
(mm)	1.15±0.10	1.15±0.10	8.00±0.30	3.50±0.05	1.75±0.10
Symbol	P1	P2	P0	ØD0	T
(mm)	2.00±0.05	2.00±0.05	4.0±0.10	1.50 <sup>+0.10</sup> <sub>-0</sub>	0.45±0.05

**Reel dimensions**

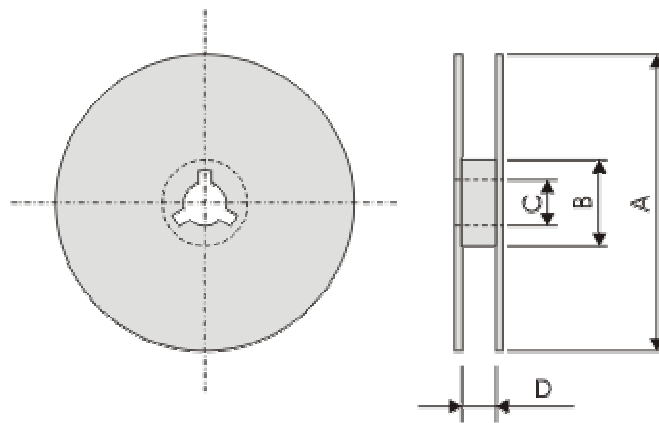

Unit: mm	A	B	C	D
7"	Φ178.0±2.0	Φ60.0±1.0	13.0±0.2	9.0±0.5
10"	Φ254.0±2.0	Φ100.0±1.0	13.0±0.2	9.0±0.5
13"	Φ330.0±2.0	Φ100.0±1.0	13.0±0.2	9.0±0.5

单击下面可查看定价，库存，交付和生命周期等信息

[>>Walsin Technology\(华新科技\(华科\)\)](#)