

CoilMaster Co.,Ltd

Head Office / R&D: 863-14, Dunsan-ri, Bongdong-eup, Wanju-gun, Jeollabuk-do, KOREA.

TEL: +82-63-263-1444 FAX: +82-31-904-1443

Korea Sales Office: Rm# 310, Ilsan Techno Town, 1141-1 Baekseok-dong, Ilsan-gu, Goyang-si, Gyeonggi-do, 411-722 Korea

TEL: 82-31-904-1444 FAX: +82-31-909-8204

China Factory: Jinshan Industry Zone Kunyu Road Wendeng City Sandong, China

TEL: 86-631-835-1444 FAX: +86-631-835-1443

URL: <http://www.coilmaster.com>

SPECIFICATION

LEAD FREE



SMD POWER INDUCTOR

CMI-DOP252010NH-SERIES

Revision history

Rev.0 13.08.28

| | Drafted by | Checked by | Approned by |
|-----------|------------|------------|-------------|
| Name | Q.Y.Z | K.H.W | C.X.Y |
| Signature | | | |
| Date | 13.08.28 | 13.08.28 | 13.08.28 |

 CoilMaster Co., Ltd

| | | | | |
|----------------|------------------------|----------------------|----------|----------|
| Customer | | SPECIFICATION | REVISION | 0 |
| | | | DATE | 13.08.28 |
| COILMASTER P/N | CMI-DOP252010NH-SERIES | SMD POWER INDUCTOR | PAGE | 2 / 10 |

Revision

| REVISION | DATE | ORIGINATED BY | REASON FOR CHANGE |
|----------|----------|---------------|-------------------|
| 0 | 13.08.28 | Q.Y.Z | FIRST RELEASED |
| | | | |

Contents

1. Dimension

- 1.1 Dimension
- 1.2 Land pattern
- 1.3 Circuit

2. Specification

- 2.1 Electrical Characteristic
- 2.2 Regulation of Part number

3. Reliability and Specification

4. Material List

5. Packing

- 4.1 Property of packing material
- 4.2 Dimension of packing material
- 4.3 Box packing and packing unit

6. RoHS Test Report

7. QC Schedule drawing

| | | | | |
|----------------|------------------------|--------------------|----------|----------|
| Customer | | SPECIFICATION | REVISION | 0 |
| | | | DATE | 13.08.28 |
| COILMASTER P/N | CMI-DOP252010NH-SERIES | SMD POWER INDUCTOR | PAGE | 3 / 10 |

1. Dimension

1.1 Dimension

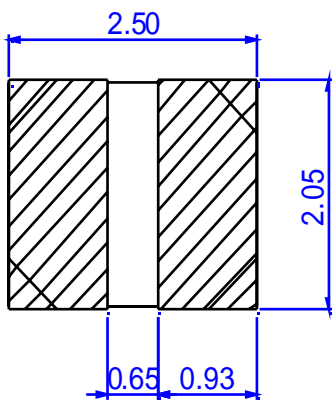
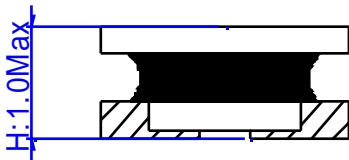
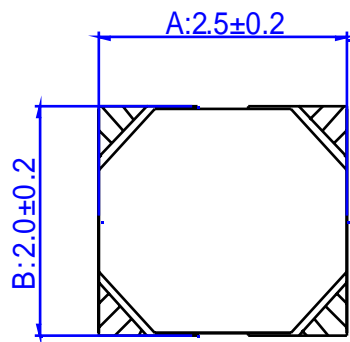

1.2 Land pattern

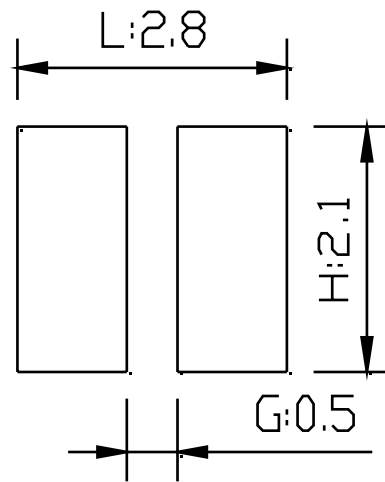

1.3 Circuit

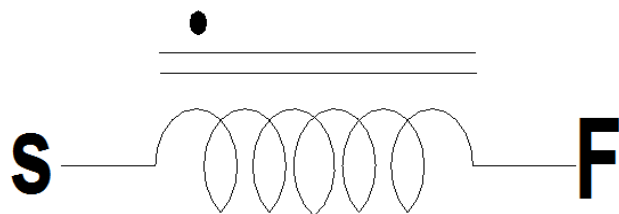

| | | | | |
|----------------|------------------------|--------------------|----------|----------|
| Customer | | SPECIFICATION | REVISION | 0 |
| | | | DATE | 13.08.28 |
| COILMASTER P/N | CMI-DOP252010NH-SERIES | SMD POWER INDUCTOR | PAGE | 4 / 10 |

2. Specification

2.1 Electrical Characteristic

| Part No. | Inductance (μH) | DCR ($\text{m}\Omega$) \pm 20% | Isat (A) Max. | Irms(A) |
|----------------------|------------------------------|------------------------------------|---------------|---------|
| CMI-DOP252010NH-R47N | 0.47 \pm 30% | 45 | 3.2 | 2.9 |
| CMI-DOP252010NH-R68N | 0.68 \pm 30% | 51 | 2.7 | 2.6 |
| CMI-DOP252010NH-1R0N | 1.0 \pm 30% | 77 | 2.6 | 2.1 |
| CMI-DOP252010NH-2R2M | 2.2 \pm 20% | 145 | 1.5 | 1.3 |
| CMI-DOP252010NH-3R3M | 3.3 \pm 20% | 225 | 1.2 | 1.0 |
| CMI-DOP252010NH-4R7M | 4.7 \pm 20% | 320 | 1.1 | 0.99 |
| CMI-DOP252010NH-6R8M | 6.8 \pm 20% | 460 | 0.86 | 0.84 |
| CMI-DOP252010NH-100M | 10. \pm 20% | 580 | 0.68 | 0.67 |
| CMI-DOP252010NH-220M | 22. \pm 20% | 1625 | 0.43 | 0.34 |
| | | | | |

- TEST FREQUENCY : 1MHz , 1.0 Vrms.
- DC current(Isat) that will cause Lo to drop approximately 30% Max.at I sat(A)
- DC current(Irms) that will cause an approximastely ΔT of 40°C
- TESTING INSTRUMENT :
 - 1) LCR METER (HP 4284A)
 - 2) DC BIAS CURRENT SOURCE (HP 42841A)

2.2 Regulation of Part number

CM
I
-
DOP
252010
NH
-
2R2
M

① ② ③ ④ ⑤ ⑥ ⑦

- ① - CoilMaster's initial
- ② - Inductor
- ③ - Series Code
- ④ - Size (unit: mm)
- ⑤ - Lead Free Type , Halogen Free
- ⑥ - Typical inductance value (2.2uH)
- ⑦ - Inductance tolerance(\pm 20%)

COILMASTER

 CoilMaster Co., Ltd.

| | | | | |
|----------------|-----------------------|--------------------|----------|----------|
| Customer | | SPECIFICATION | REVISION | 0 |
| | | | DATE | 13.08.28 |
| COILMASTER P/N | CM-DOP252010NH-SERIES | SMD POWER INDUCTOR | PAGE | 5 / 10 |

2.3 Current Characteristic

2.3.1 DC current(I_{sat})

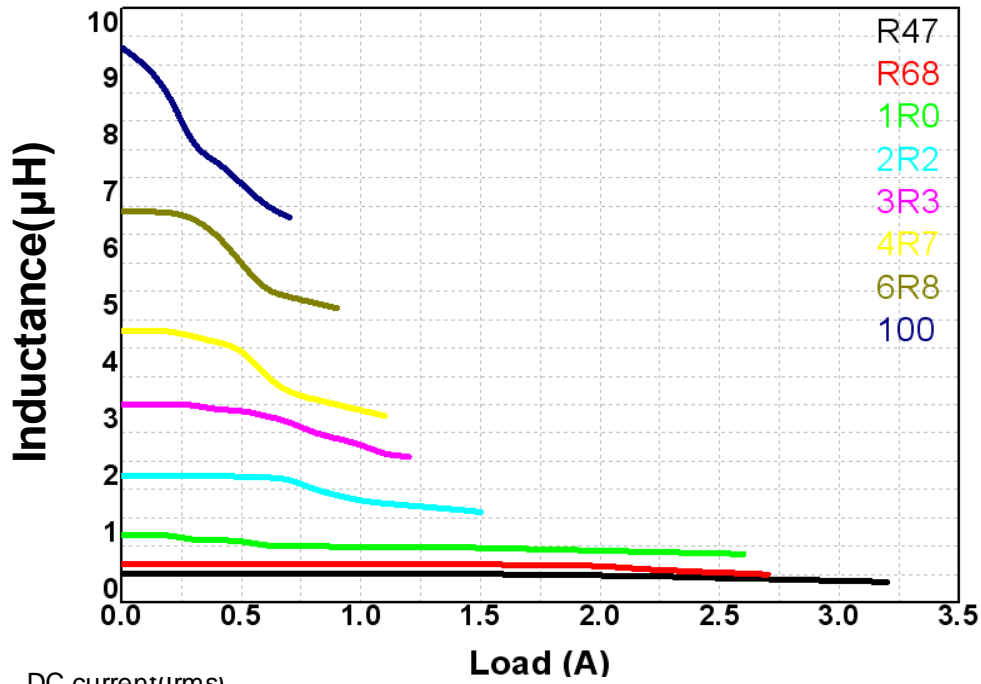

2.3.1 DC current(I_{rms})

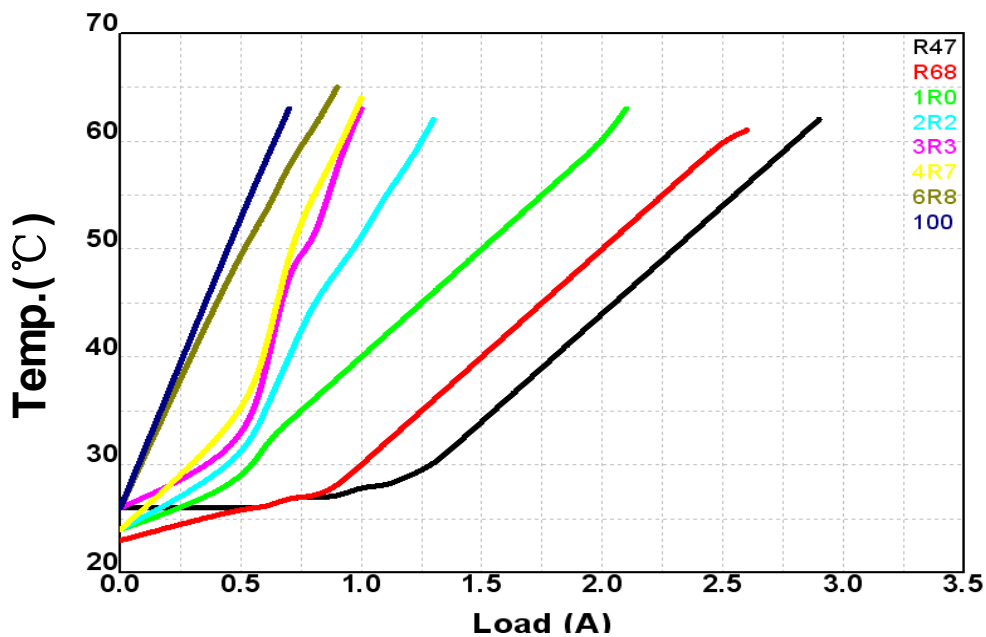

COILMASTER

| | | | | |
|----------------|------------------------|--------------------|----------|----------|
| Customer | | SPECIFICATION | REVISION | 0 |
| | | | DATE | 13.08.28 |
| COILMASTER P/N | CMI-DOP252010NH Series | SMD POWER INDUCTOR | PAGE | 6 / 10 |

3.. RELIABILITY AND SPECIFICATION

3-1. MECHANICAL TESTS

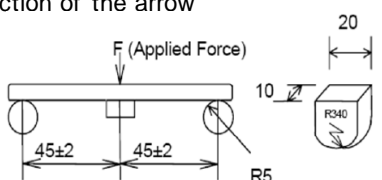
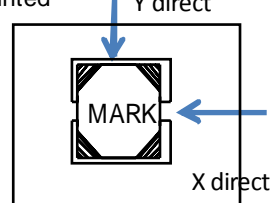
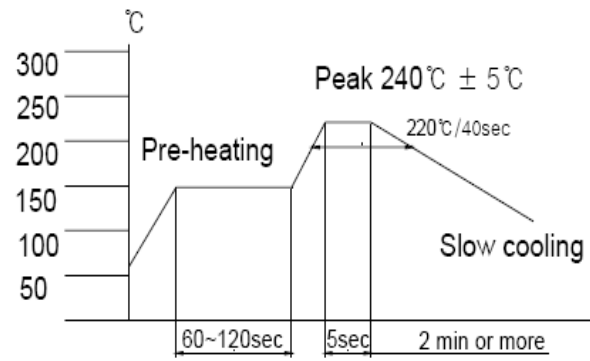
| No. | TEST ITEM | SPECIFICATION | TEST DETAILS |
|-----|---|--|--|
| 1 | Electrode strength (bendability of substrate) | $\Delta L/L_0 \leq \pm 5\%$ There shall be no mechanical or electrical damage | The sample shall be soldered onto the printed circuit board in figure 1 and the load is applied until the bending in the direction of the arrow is approximately 3mm (Hold Time = 30seconds)  |
| 2 | Electrode adhesion (sticking-tendency) | $\Delta L/L_0 \leq \pm 5\%$ There shall be no mechanical or electrical damage | the sample shall be soldered on the printed circuit board, Force of 10N(1.02Kgf) shall be applied with pressing jig. Holding time is 5seconds;  |
| 3 | Vibration Test | $\Delta L/L_0 \leq \pm 5\%$ There shall be no mechanical damage | The sample is soldered onto the printed circuit board. It is then a vibration test as follows : Vibration Amplitude = 1.52mm Frequency varies from 10Hz to 55Hz and back over a 1 minute period The test is carried out in the 3 directions (X, Y, Z) for 2 hours each (A total of 6 hours) |
| 4 | Resistance to soldering heat (Ref low soldering) (Manual soldering) | There shall be no damage | Then remain the following condition 2 times. Measure the test items after leaving them in normal temperature and humidity for more than 1 hour.  |
| | | $\Delta L/L_0 \leq \pm 5\%$ There shall be no mechanical damage | Using soldering iron Max. tip temperature : $350 \pm 10^\circ\text{C}$ Max. exposure time : 3 ± 1 sec Upon completion of the test, the measurement shall be made after the sample has been left in a normal temperature and normal humidity for hour. |

| | | | | |
|----------------|------------------------|---------------------------|----------|----------|
| Customer | | SPECIFICATION | REVISION | 0 |
| | | | DATE | 13.08.28 |
| COILMASTER P/N | CMI-DOP252010NH Series | SMD POWER INDUCTOR | PAGE | 7 / 10 |

3-2. ENVIROMENTAL CHARAC

| No. | TEST ITEM | SPECIFICATION | TEST DETAILS | | | | | | | | | | | | | | | |
|--|--------------------------|--|--|-----|-------------|----------|---|---------|--------|---|----------------------|--------------------------|---|---------|-------|---|----------------------|--------------------------|
| 5 | High Temperature Storage | $\Delta L/L_0 \leq \pm 5\%$ There shall be no mechanical damage | The sample shall be left for 500±12 hours in an atmosphere with a temperature of 105±2°C and normal humidity. Upon completion of the test the measurement shall be made after the sample has been left in a normal temperature and normal humidity for 1 hour. | | | | | | | | | | | | | | | |
| 6 | Low Temperature Storage | $\Delta L/L_0 \leq \pm 5\%$ There shall be no mechanical | The sample shall be left for 500±12 hours in an atmosphere with a temperature of -40±3°C. Upon completion of the test, the measurement shall be made after the sample has been left in a normal temperature and normal humidity for 1 hour. | | | | | | | | | | | | | | | |
| Table 2 | | | | | | | | | | | | | | | | | | |
| <table border="1" style="margin-left: auto; margin-right: auto;"> <thead> <tr> <th>No.</th> <th>Temperature</th> <th>Duration</th> </tr> </thead> <tbody> <tr> <td>1</td> <td>-25±2°C</td> <td>30 min</td> </tr> <tr> <td>2</td> <td>Standard Atmospheric</td> <td>5 sec or less NO1→No2</td> </tr> <tr> <td>3</td> <td>+85±2°C</td> <td>30min</td> </tr> <tr> <td>4</td> <td>Standard Atmospheric</td> <td>5 sec or less NO1→No2</td> </tr> </tbody> </table> | | | | No. | Temperature | Duration | 1 | -25±2°C | 30 min | 2 | Standard Atmospheric | 5 sec or less NO1→No2 | 3 | +85±2°C | 30min | 4 | Standard Atmospheric | 5 sec or less NO1→No2 |
| No. | Temperature | Duration | | | | | | | | | | | | | | | | |
| 1 | -25±2°C | 30 min | | | | | | | | | | | | | | | | |
| 2 | Standard Atmospheric | 5 sec or less NO1→No2 | | | | | | | | | | | | | | | | |
| 3 | +85±2°C | 30min | | | | | | | | | | | | | | | | |
| 4 | Standard Atmospheric | 5 sec or less NO1→No2 | | | | | | | | | | | | | | | | |
| 8 | Moisture Storage | $\Delta L/L_0 \leq \pm 5\%$ There shall be no mechanical damage | The sample shall be left 500±4 hours in a temperay ure of +40±2°C and a humidity (RH) of 90 ~ 95% Upon completion of the test, the measurement shall be made of left in a normal temperature and normal humidity more than 1 hour. (NO Bias) | | | | | | | | | | | | | | | |

13-3. ENVIROMENTAL CHARACTERISTICS

| No. | TEST ITEM | SPECIFICATION | TEST DETAILS |
|-----|---------------|---|--|
| 9 | Solderability | At least 75% Area should be covered with new solder | The sample shall be immersed for 5 to 10 seconds in flux. Then immersed in molten solder at 240±5°C for 3+1/-0 seconds |

| | | | | |
|----------------|------------------------|--------------------|----------|----------|
| Customer | | SPECIFICATION | REVISION | 0 |
| | | | DATE | 13.08.28 |
| COILMASTER P/N | CMI-DOP252010NH-SERIES | SMD POWER INDUCTOR | PAGE | 8 / 10 |

4. Material List

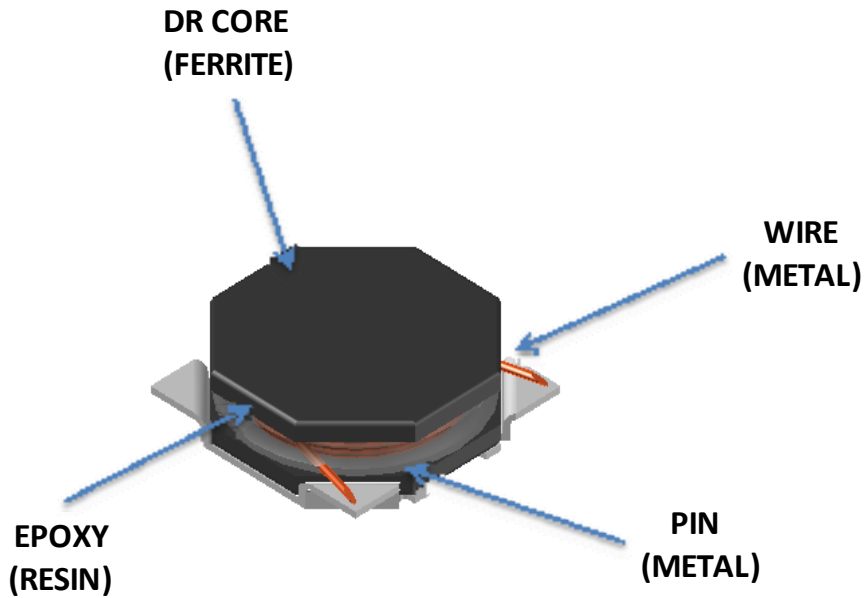

| NO | ITEM | MATERIAL & DIMENISON | | MANUFACTURER | SAFETY |
|----|-------------------|----------------------|-------------|--------------------|--------------------|
| 1 | DR CORE (FERRITE) | 2.47*1.97*0.87 | | S-(D.G) CORP. | |
| 2 | PIN (METAL) | DOP252010NH | | L-FACTORY | |
| 3 | WIRE (METAL) | E180 EIW | Ø0.07~0.20 | E-CORP. Y-CORP. | E143312 E225155 |
| 4 | EPOXY (RESIN) | EPOXY 1 | EPOXY RESIN | P-CORP. | |
| | | EPOXY 2 | | C-CORP. | |

| | | | | |
|----------------|------------------------|---------------------------|----------|----------|
| Customer | | SPECIFICATION | REVISION | 0 |
| | | | DATE | 13.08.28 |
| COILMASTER P/N | CMI-DOP252012NH-SERIES | SMD POWER INDUCTOR | PAGE | 9 / 10 |

5. Packing

5.1 Property of packing material

| | |
|---------------------------------|--------------------------------|
| Tensile of carrier tape | 10N (1kgf) Min. |
| Tensile of cover tape | 10N (1kgf) Min. |
| Adhesive strength of cover tape | 0.1 N (10gf) ~ 0.7 N(70gf) |
| Pulling degree of carrier tape | 165° ~ 180° |
| Spin speed of reel | 300mm / min |

5.2 Dimension of packing material

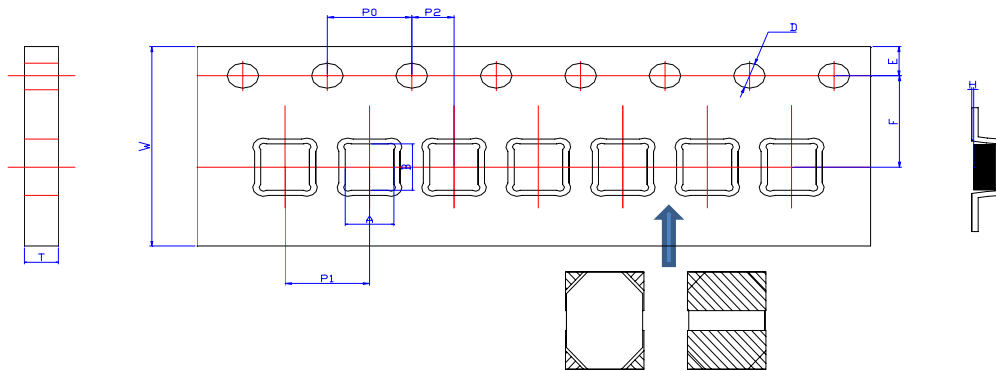

| A | B | W | F | E | P1 | P2 | P0 | D | T |
|----------|----------|-------|---------|----------|-------|-------|-------|---------|-----------|
| 2.45±0.1 | 2.85±0.1 | 8±0.1 | 3.5±0.1 | 1.75±0.1 | 4±0.1 | 2±0.1 | 4±0.1 | 1.5±0.1 | 0.25±0.05 |

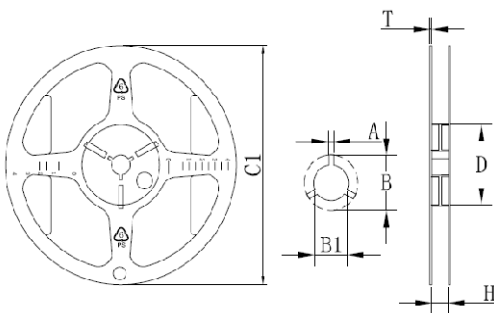

<SPQ Box>



<PQ Box>

| C1 | A | B | B1 |
|--------|---------|----------|----------|
| 178±1 | 2.6±0.3 | 22.5±0.5 | 13.5±0.3 |
| D | T | H | |
| 60±0.5 | 1±0.2 | 9.0±0.5 | |

| Packing unit | Quantity |
|--------------|-------------------------------------|
| Reel | 3,000pcs / reel |
| Middle box | 5 Reel / box (15,000pcs) |
| Large box | 2 Middle boxes, 4 Reels (60,000pcs) |

COILMASTER

CoilMaster Co.,Ltd.



















| | | | | |
|----------------|------------------------|--------------------|----------|----------|
| Customer | | SPECIFICATION | REVISION | 0 |
| | | | DATE | 13.08.28 |
| COILMASTER P/N | CMI-DOP252010NH-SERIES | SMD POWER INDUCTOR | PAGE | 10 / 10 |

6.RoHS TEST REPORT

| No. | Part Name | 실측 무게 (총중량) | Substance Content(ppm) | | | | | | | |
|-----|-----------|----------------|------------------------|-------|-----|------|------|-------|-----|-----|
| | | | Pb | Cd | Hg | Cr+6 | PBBs | PBDEs | Br | Cl |
| | | | 200/700 | 50/70 | 700 | 700 | 100 | 100 | 900 | 900 |
| 1 | DR CORE | 0.028g | 0 | 0 | 0 | 0 | 0 | 0 | 0 | 0 |
| 2 | PIN | | 41.9 | 0 | 0 | 0 | 0 | 0 | 0 | 0 |
| 3 | WIRE | | 0 | 0 | 0 | 0 | 0 | 0 | 0 | 0 |
| 4 | EPOXY(1) | | 0 | 0 | 0 | 0 | 0 | 0 | 0 | 620 |
| 5 | EPOXY(2) | | 0 | 0 | 0 | 0 | 0 | 0 | 0 | 263 |

COILMASTER

 CoilMaster Co., Ltd.

| Product | | CMI-DOP series | | <h1>QC Flow Chart</h1> | | | Approval |
|---------|---|---|-------------------------------|---|--|--|---|
| Rev. | | 0 | | | | |  |
| Date | | 2012.04.17 | | | | | |
| No | Flow Chart | Process | Equipment | Control Item | Measurement | Document | |
| 1 |  | IQC | | 1)Appearance 2)Size 3)Characteristic 4)Quantity | Visual | Inspection guidelines | |
| 2 |  | Core Arrange | Arrange Jig | 1)DRCore Standard 2)DRCore Arrange condition | Visual | Process instructions | |
| 3 |  | Epoxy painting | Epoxy painting Jig | 1)Epoxy Standard 2)Epoxy storage condition 3)Epoxy paint condition | 1)Visual 2)Thermometer 3)Visual | Process instructions | |
| 4 |  | Pin Adhesion | | 1)Pin adhesion condition | Visual | Process instructions | |
| 5 |  | Dry | Dry oven | 1)Dry time/temperature 2)Dry condition 3)Dry state | 1)Timer/Thermometer 2)Visual 3)Push/Pull Gauge | Process instructions | |
| 6 |  | Core and PIN arranging inspection | | 1)arranging condition | Microscope | Inspection guidelines | |
| 7 |  | Winding | Winding M/C | 1)Wire Standard 2)Wire Turn number 3)Wire condition | 1)Calipers 2)Calipers 3)Visual | Process instructions | |
| 8 |  | Welding (CTQ) | Welding M/C | 1)Welding Current 2)Welding Pressure 3)Welding Time | Visual | Process instructions | |
| 9 |  | Wire cutting | Cutting M/C | 1)Cutting condition | Visual | Process instructions | |
| 10 |  | Winding and welding Inspection | | 1)Winding condition 2)welding condition 3)Wire cutting condition | Microscope | Inspection guidelines | |
| 11 |  | Epoxy painting | Epoxy painting Jig | 1)Epoxy Standard 2)Epoxy storage condition 3)Epoxy paint condition | 1)Visual 2)Thermometer 3)Visual | Process instructions | |
| 12 |  | Dry | Dry oven | 1)Dry time/temperature 2)Dry condition | 1)Timer/Thermometer 2)Visual | Process instructions | |
| 13 |  | PIN cutting | Cutting M/C | 1)Cutting condition | Visual | Process instructions | |
| 14 |  | Visual sorting | Visual sorting M/C | 1)Marking condition 2)CORE condition 3)PIN condition | Visual/Magnifier | Visual guidelines Appearance Guidelines | |
| 15 |  | Characteristic sorting | Characteristic sorting M/C | 1)Inductance 2)Resistance | LCR METER DCR METER | Characteristic guidelines | |
| 16 |  | OQC 1 | Reflow M/C | 1)Inductance/Resistance 2)DC Bias 3)Reflow Test | LCR METER DCR METER | Inspection guidelines | |
| 17 |  | REEL Packing | Packing M/C | 1)Packing condition 2)Packing Quantity 3)Adhesive Strength 4)Label | Strength measuring gauge | Packing guidelines | |
| 18 |  | OQC 2 | | 1)Packing condition 2)Label condition | Visual | Inspection guidelines | |

单击下面可查看定价，库存，交付和生命周期等信息

[>>coilmaster\(卡尔马斯特\)](#)