

CoilMaster Co.,Ltd

Head Office / R&D: 863-14, Dunsan-ri, Bongdong-eup, Wanju-gun, Jeollabuk-do, KOREA.

TEL: +82-63-263-1444 FAX: +82-31-904-1443

Korea Sales Office: Rm# 310, Ilsan Techno Town, 1141-1 Baekseok-dong, Ilsan-gu, Goyang-si, Gyeonggi-do, 411-722 Korea

TEL: 82-31-904-1444 FAX: +82-31-909-8204

China Factory: Jinshan Industry Zone Kunyu Road Wendeng City Sandong, China

TEL: 86-631-835-1444 FAX: +86-631-835-1443

URL: <http://www.coilmaster.com>

SPECIFICATION

LEAD FREE



SMD POWER INDUCTOR

CMI-DOP252010NH-SERIES

Revision history

Rev.0 13.08.28

	Drafted by	Checked by	Approned by
Name	Q.Y.Z	K.H.W	C.X.Y
Signature			
Date	13.08.28	13.08.28	13.08.28

 CoilMaster Co., Ltd

Customer		SPECIFICATION	REVISION	0
			DATE	13.08.28
COILMASTER P/N	CMI-DOP252010NH-SERIES	SMD POWER INDUCTOR	PAGE	2 / 10

Revision

REVISION	DATE	ORIGINATED BY	REASON FOR CHANGE
0	13.08.28	Q.Y.Z	FIRST RELEASED

Contents

1. Dimension

- 1.1 Dimension
- 1.2 Land pattern
- 1.3 Circuit

2. Specification

- 2.1 Electrical Characteristic
- 2.2 Regulation of Part number

3. Reliability and Specification

4. Material List

5. Packing

- 4.1 Property of packing material
- 4.2 Dimension of packing material
- 4.3 Box packing and packing unit

6. RoHS Test Report

7. QC Schedule drawing

Customer		SPECIFICATION	REVISION	0
			DATE	13.08.28
COILMASTER P/N	CMI-DOP252010NH-SERIES	SMD POWER INDUCTOR	PAGE	3 / 10

1. Dimension

1.1 Dimension

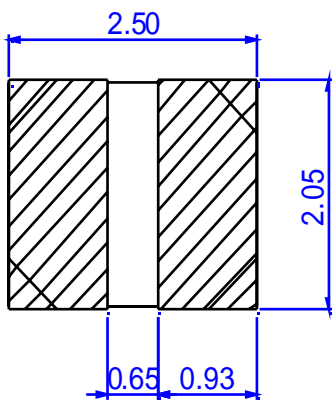
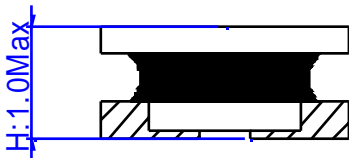
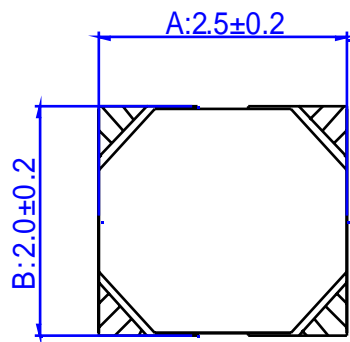

1.2 Land pattern

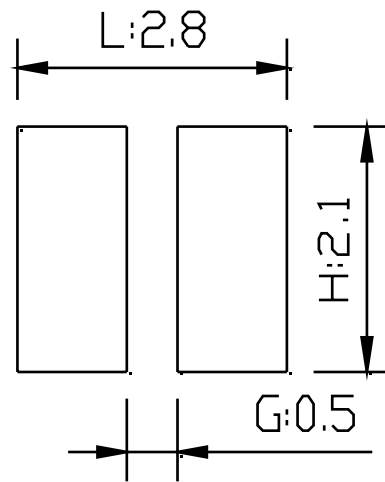

1.3 Circuit

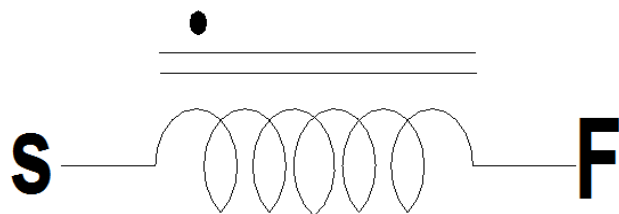

Customer		SPECIFICATION	REVISION	0
			DATE	13.08.28
COILMASTER P/N	CMI-DOP252010NH-SERIES	SMD POWER INDUCTOR	PAGE	4 / 10

2. Specification

2.1 Electrical Characteristic

Part No.	Inductance (μH)	DCR ($\text{m}\Omega$) \pm 20%	Isat (A) Max.	Irms(A)
CMI-DOP252010NH-R47N	0.47 \pm 30%	45	3.2	2.9
CMI-DOP252010NH-R68N	0.68 \pm 30%	51	2.7	2.6
CMI-DOP252010NH-1R0N	1.0 \pm 30%	77	2.6	2.1
CMI-DOP252010NH-2R2M	2.2 \pm 20%	145	1.5	1.3
CMI-DOP252010NH-3R3M	3.3 \pm 20%	225	1.2	1.0
CMI-DOP252010NH-4R7M	4.7 \pm 20%	320	1.1	0.99
CMI-DOP252010NH-6R8M	6.8 \pm 20%	460	0.86	0.84
CMI-DOP252010NH-100M	10. \pm 20%	580	0.68	0.67
CMI-DOP252010NH-220M	22. \pm 20%	1625	0.43	0.34

- TEST FREQUENCY : 1MHz , 1.0 Vrms.
- DC current(Isat) that will cause Lo to drop approximately 30% Max.at I sat(A)
- DC current(Irms) that will cause an approximastely ΔT of 40°C
- TESTING INSTRUMENT :
 - 1) LCR METER (HP 4284A)
 - 2) DC BIAS CURRENT SOURCE (HP 42841A)

2.2 Regulation of Part number

CM	I	-	DOP	252010	NH	-	2R2	M
①	②		③	④	⑤		⑥	⑦

- ① - CoilMaster's initial
- ② - Inductor
- ③ - Series Code
- ④ - Size (unit: mm)
- ⑤ - Lead Free Type , Halogen Free
- ⑥ - Typical inductance value (2.2uH)
- ⑦ - Inductance tolerance(\pm 20%)

COILMASTER

 CoilMaster Co., Ltd.

Customer		SPECIFICATION	REVISION	0
			DATE	13.08.28
COILMASTER P/N	CM-DOP252010NH-SERIES	SMD POWER INDUCTOR	PAGE	5 / 10

2.3 Current Characteristic

2.3.1 DC current(Isat)

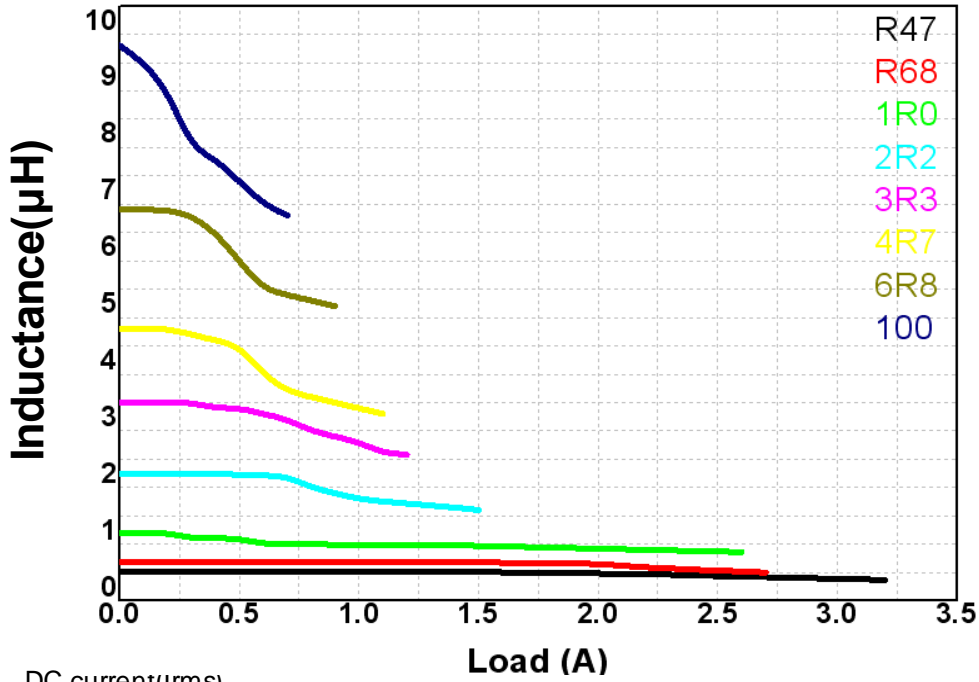

2.3.1 DC current(Irms)

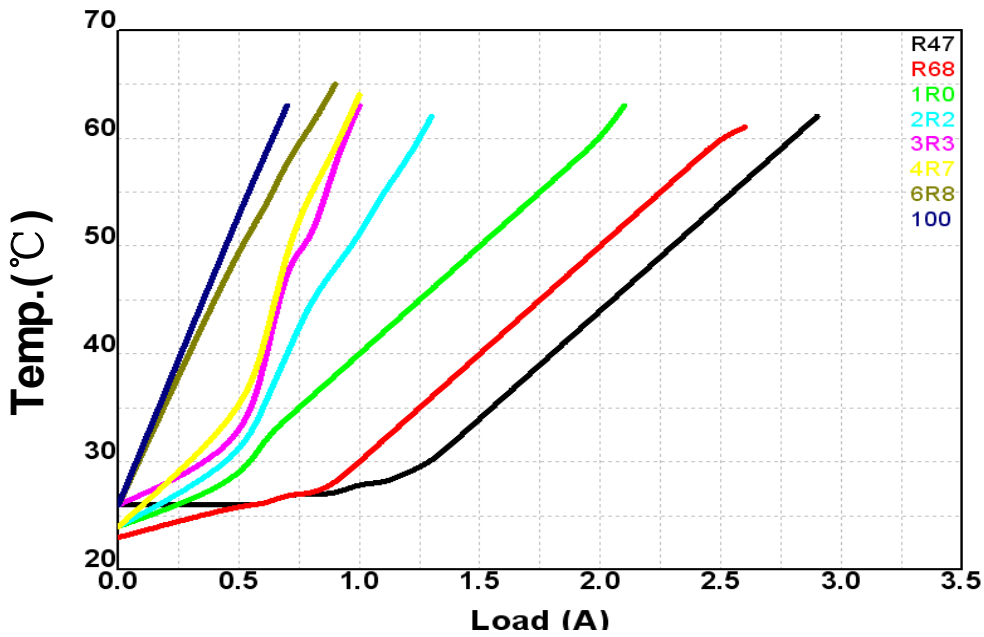

COILMASTER

Customer		SPECIFICATION	REVISION	0
			DATE	13.08.28
COILMASTER P/N	CMI-DOP252010NH Series	SMD POWER INDUCTOR	PAGE	6 / 10

3.. RELIABILITY AND SPECIFICATION

3-1. MECHANICAL TESTS

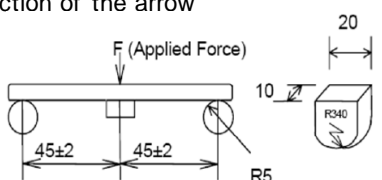
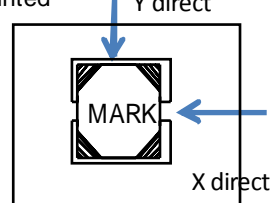
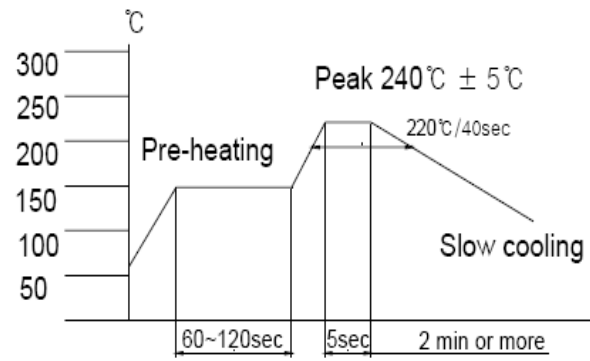
No.	TEST ITEM	SPECIFICATION	TEST DETAILS
1	Electrode strength (bendability of substrate)	$\Delta L/L_0 \leq \pm 5\%$ There shall be no mechanical or electrical damage	The sample shall be soldered onto the printed circuit board in figure 1 and the load is applied until the bending in the direction of the arrow is approximately 3mm (Hold Time = 30seconds) 
2	Electrode adhesion (sticking-tendency)	$\Delta L/L_0 \leq \pm 5\%$ There shall be no mechanical or electrical damage	the sample shall be soldered on the printed circuit board, Force of 10N(1.02Kgf) shall be applied with pressing jig. Holding time is 5seconds; 
3	Vibration Test	$\Delta L/L_0 \leq \pm 5\%$ There shall be no mechanical damage	The sample is soldered onto the printed circuit board. It is then a vibration test as follows : Vibration Amplitude = 1.52mm Frequency varies from 10Hz to 55Hz and back over a 1 minute period The test is carried out in the 3 directions (X, Y, Z) for 2 hours each (A total of 6 hours)
4	Resistance to soldering heat (Ref low soldering) (Manual soldering)	There shall be no damage	Then remain the following condition 2 times. Measure the test items after leaving them in normal temperature and humidity for more than 1 hour. 
		$\Delta L/L_0 \leq \pm 5\%$ There shall be no mechanical damage	Using soldering iron Max. tip temperature : $350 \pm 10^\circ\text{C}$ Max. exposure time : 3 ± 1 sec Upon completion of the test, the measurement shall be made after the sample has been left in a normal temperature and normal humidity for hour.

Customer		SPECIFICATION	REVISION	0
			DATE	13.08.28
COILMASTER P/N	CMI-DOP252010NH Series	SMD POWER INDUCTOR	PAGE	7 / 10

3-2. ENVIROMENTAL CHARAC

No.	TEST ITEM	SPECIFICATION	TEST DETAILS															
5	High Temperature Storage	$\Delta L/L_0 \leq \pm 5\%$ There shall be no mechanical damage	The sample shall be left for 500±12 hours in an atmosphere with a temperature of 105±2°C and normal humidity. Upon completion of the test the measurement shall be made after the sample has been left in a normal temperature and normal humidity for 1 hour.															
6	Low Temperature Storage	$\Delta L/L_0 \leq \pm 5\%$ There shall be no mechanical	The sample shall be left for 500±12 hours in an atmosphere with a temperature of -40±3°C. Upon completion of the test, the measurement shall be made after the sample has been left in a normal temperature and normal humidity for 1 hour. <p style="text-align: center;">Table 2</p> <table border="1" style="margin-left: auto; margin-right: auto;"> <thead> <tr> <th>No.</th> <th>Temperature</th> <th>Duration</th> </tr> </thead> <tbody> <tr> <td>1</td> <td>-25±2°C</td> <td>30 min</td> </tr> <tr> <td>2</td> <td>Standard Atmospheric</td> <td>5 sec or less NO1→No2</td> </tr> <tr> <td>3</td> <td>+85±2°C</td> <td>30min</td> </tr> <tr> <td>4</td> <td>Standard Atmospheric</td> <td>5 sec or less NO1→No2</td> </tr> </tbody> </table>	No.	Temperature	Duration	1	-25±2°C	30 min	2	Standard Atmospheric	5 sec or less NO1→No2	3	+85±2°C	30min	4	Standard Atmospheric	5 sec or less NO1→No2
No.	Temperature	Duration																
1	-25±2°C	30 min																
2	Standard Atmospheric	5 sec or less NO1→No2																
3	+85±2°C	30min																
4	Standard Atmospheric	5 sec or less NO1→No2																
8	Moisture Storage	$\Delta L/L_0 \leq \pm 5\%$ There shall be no mechanical damage	The sample shall be left 500±4 hours in a temperay ure of +40±2°C and a humidity (RH) of 90 ~ 95% Upon completion of the test, the measurement shall be made of left in a normal temperature and normal humidity more than 1 hour. (NO Bias)															

13-3. ENVIROMENTAL CHARACTERISTICS

No.	TEST ITEM	SPECIFICATION	TEST DETAILS
9	Solderability	At least 75% Area should be covered with new solder	The sample shall be immersed for 5 to 10 seconds in flux. Then immersed in molten solder at 240±5°C for 3+1/-0 seconds

Customer		SPECIFICATION	REVISION	0
			DATE	13.08.28
COILMASTER P/N	CMI-DOP252010NH-SERIES	SMD POWER INDUCTOR	PAGE	8 / 10

4. Material List

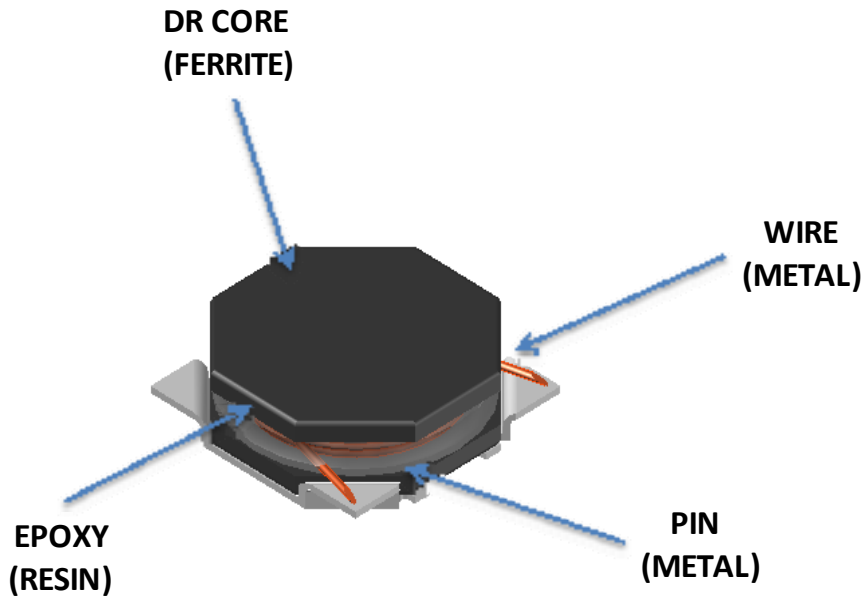

NO	ITEM	MATERIAL & DIMENISON		MANUFACTURER	SAFETY
1	DR CORE (FERRITE)	2.47*1.97*0.87		S-(D.G) CORP.	
2	PIN (METAL)	DOP252010NH		L-FACTORY	
3	WIRE (METAL)	E180 EIW	Ø0.07~0.20	E-CORP. Y-CORP.	E143312 E225155
4	EPOXY (RESIN)	EPOXY 1	EPOXY RESIN	P-CORP.	
		EPOXY 2		C-CORP.	

Customer		SPECIFICATION	REVISION	0
			DATE	13.08.28
COILMASTER P/N	CMI-DOP252012NH-SERIES	SMD POWER INDUCTOR	PAGE	9 / 10

5. Packing

5.1 Property of packing material

Tensile of carrier tape	10N (1kgf) Min.
Tensile of cover tape	10N (1kgf) Min.
Adhesive strength of cover tape	0.1 N (10gf) ~ 0.7 N(70gf)
Pulling degree of carrier tape	165° ~ 180°
Spin speed of reel	300mm / min

5.2 Dimension of packing material

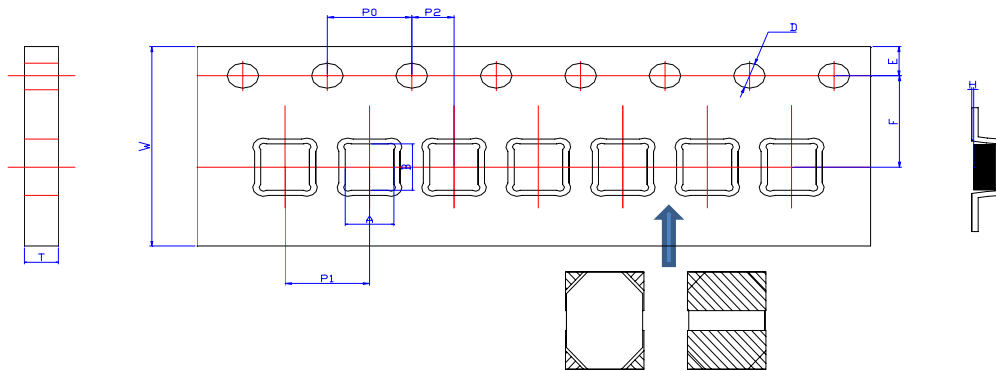

A	B	W	F	E	P ₁	P ₂	P ₀	D	T
2.45±0.1	2.85±0.1	8±0.1	3.5±0.1	1.75±0.1	4±0.1	2±0.1	4±0.1	1.5±0.1	0.25±0.05

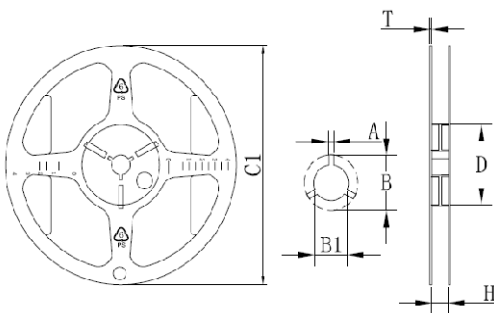

<SPQ Box>



<PQ Box>

C1	A	B	B1
178±1	2.6±0.3	22.5±0.5	13.5±0.3
D	T	H	
60±0.5	1±0.2	9.0±0.5	

Packing unit	Quantity
Reel	3,000pcs / reel
Middle box	5 Reel / box (15,000pcs)
Large box	2 Middle boxes, 4 Reels (60,000pcs)

COILMASTER

CoilMaster Co.,Ltd.



















Customer		SPECIFICATION	REVISION	0
			DATE	13.08.28
COILMASTER P/N	CMI-DOP252010NH-SERIES	SMD POWER INDUCTOR	PAGE	10 / 10

6.RoHS TEST REPORT

No.	Part Name	실측 무게 (총중량)	Substance Content(ppm)							
			Pb	Cd	Hg	Cr+6	PBBs	PBDEs	Br	Cl
			200/700	50/70	700	700	100	100	900	900
1	DR CORE	0.028g	0	0	0	0	0	0	0	0
2	PIN		41.9	0	0	0	0	0	0	0
3	WIRE		0	0	0	0	0	0	0	0
4	EPOXY(1)		0	0	0	0	0	0	0	620
5	EPOXY(2)		0	0	0	0	0	0	0	263

COILMASTER

 CoilMaster Co., Ltd.

Product		CMI-DOP series		<h1 style="text-align: center;">QC Flow Chart</h1>			Approval
Rev.		0					
Date		2012.04.17					
No	Flow Chart	Process	Equipment	Control Item	Measurement	Document	
1		IQC		1)Appearance 2)Size 3)Characteristic 4)Quantity	Visual	Inspection guidelines	
2		Core Arrange	Arrange Jig	1)DRCore Standard 2)DRCore Arrange condition	Visual	Process instructions	
3		Epoxy painting	Epoxy painting Jig	1)Epoxy Standard 2)Epoxy storage condition 3)Epoxy paint condition	1)Visual 2)Thermometer 3)Visual	Process instructions	
4		Pin Adhesion		1)Pin adhesion condition	Visual	Process instructions	
5		Dry	Dry oven	1)Dry time/temperature 2)Dry condition 3)Dry state	1)Timer/Thermometer 2)Visual 3)Push/Pull Gauge	Process instructions	
6		Core and PIN arranging inspection		1)arranging condition	Microscope	Inspection guidelines	
7		Winding	Winding M/C	1)Wire Standard 2)Wire Turn number 3)Wire condition	1)Calipers 2)Calipers 3)Visual	Process instructions	
8		Welding (CTQ)	Welding M/C	1)Welding Current 2)Welding Pressure 3)Welding Time	Visual	Process instructions	
9		Wire cutting	Cutting M/C	1)Cutting condition	Visual	Process instructions	
10		Winding and welding Inspection		1)Winding condition 2)welding condition 3)Wire cutting condition	Microscope	Inspection guidelines	
11		Epoxy painting	Epoxy painting Jig	1)Epoxy Standard 2)Epoxy storage condition 3)Epoxy paint condition	1)Visual 2)Thermometer 3)Visual	Process instructions	
12		Dry	Dry oven	1)Dry time/temperature 2)Dry condition	1)Timer/Thermometer 2)Visual	Process instructions	
13		PIN cutting	Cutting M/C	1)Cutting condition	Visual	Process instructions	
14		Visual sorting	Visual sorting M/C	1)Marking condition 2)CORE condition 3)PIN condition	Visual/Magnifier	Visual guidelines Appearance Guidelines	
15		Characteristic sorting	Characteristic sorting M/C	1)Inductance 2)Resistance	LCR METER DCR METER	Characteristic guidelines	
16		OQC 1	Reflow M/C	1)Inductance/Resistance 2)DC Bias 3)Reflow Test	LCR METER DCR METER	Inspection guidelines	
17		REEL Packing	Packing M/C	1)Packing condition 2)Packing Quantity 3)Adhesive Strength 4)Label	Strength measuring gauge	Packing guidelines	
18		OQC 2		1)Packing condition 2)Label condition	Visual	Inspection guidelines	

单击下面可查看定价，库存，交付和生命周期等信息

[>>coilmaster\(卡尔马斯特\)](#)