

- ✓ High-data-rate transfer, ideal for eDP HBR 2 (5.4 Gbps) applications.
- ✓ Simultaneous soldering of different size cables for micro-coaxial and discrete wire.
- ✓ Click sensation provides audible and tactile check for proper mating.

Pin counts:

Range	30 – 50
Available	30, 40, 50

*Please inquire for pin counts not listed or outside of the pin count range.

Mating Type	Right angle vertical	
Wire Pitch (mm)	0.5	
Board Pitch (mm)	0.5	
Mated Size (mm)	Height	2.2 +/- 0.2
	Width Formula	5.8 + (0.5*?p)
	Depth	6.1
Wiping Length (mm)	0.51	
Applicable Wire (AWG#)	Micro-coax for Signals	45Ω : #36 or smaller 50Ω : #38 or smaller
	Twincoax	#40
	Discrete	#32 or smaller
Compatibility	-	
Performance (Reference Only)	eDP HBR 2 (5.4 Gbps) USB 3.1 Gen 1 (5 Gbps)	

High-Data-Rate Transfer, Ideal for eDP HBR 2 (5.4 Gbps) Applications

Eye pattern (Differential)
Bit rate : 5.4 Gbps
Rise time : 60ps (10-90%)
Input voltage : 800mVp-p

*Please contact I-PEX Connectors for more test details.

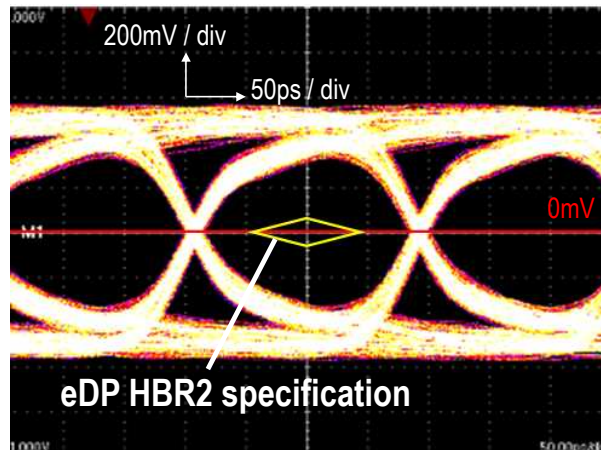

Simultaneous Soldering of Different Size Cables for Micro-coaxial and Discrete Wire

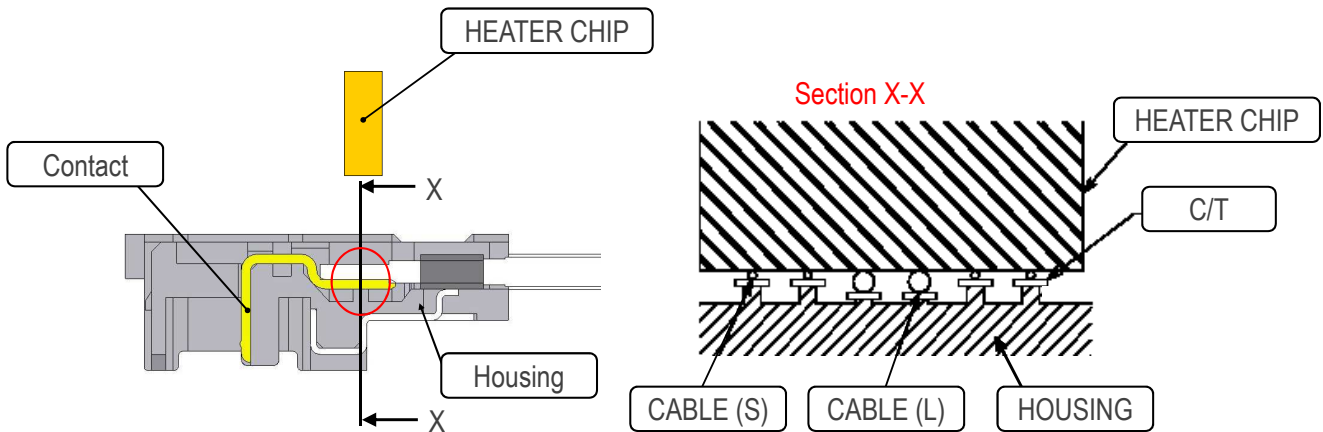

Click Sensation Provides Audible and Tactile Check for Proper Mating

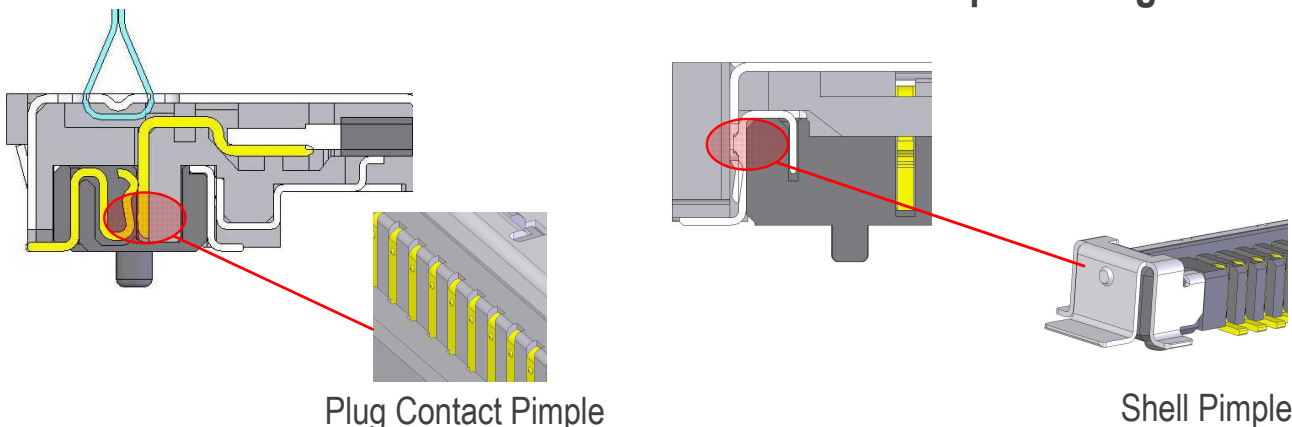

FPL II[®]

Component Parts Detail

Component Parts:

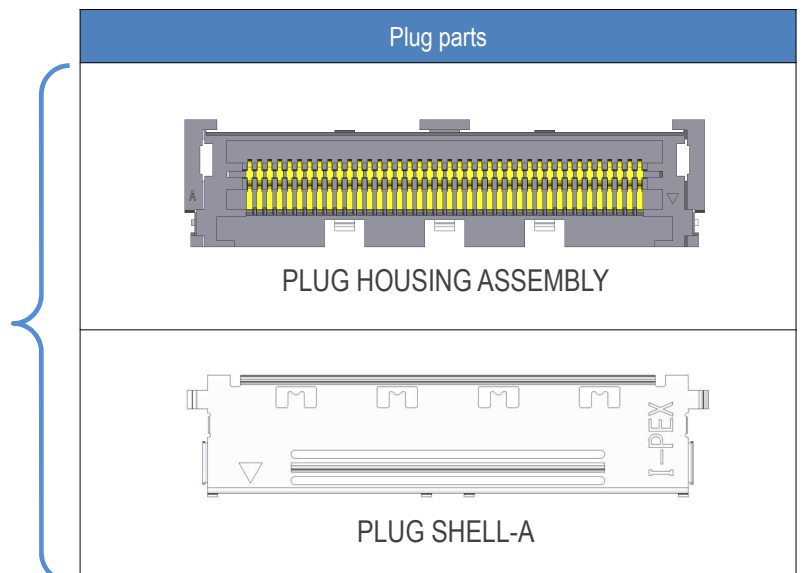
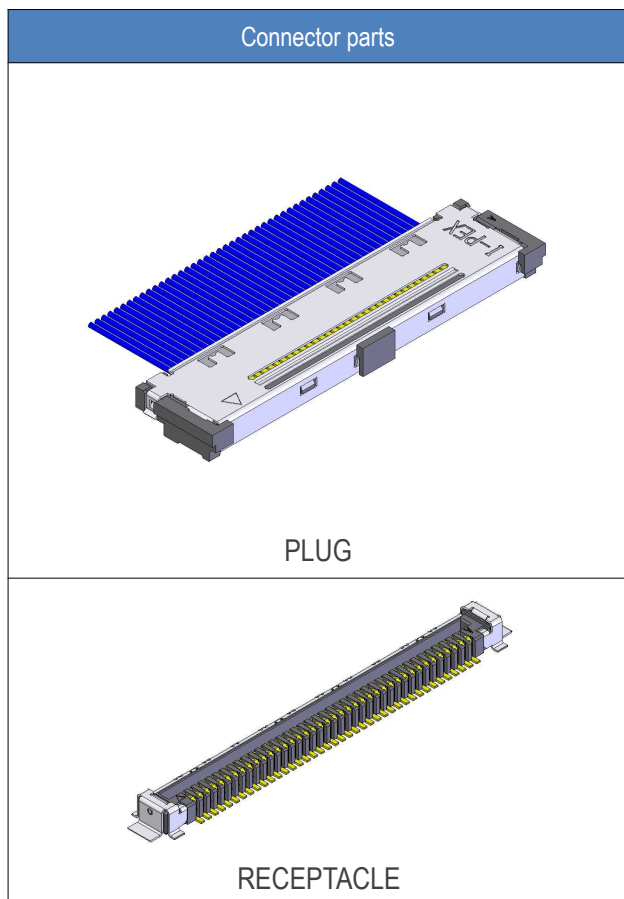

Plug Cable Assembly :

Recommended P/N		20437-0**T-01		
PART No.	POS.	A	B	C
20437-030T-1	30	14.50	10.50	20.80
20437-040T-1	40	19.50	15.50	25.80
20437-050T-1	50	24.50	20.50	30.80



CABLE ASSY PART No.	HOUSING ASSY PART No.	SHELL-A PART No.	CONTACT FINISH (MATING AREA)
20437-0**T-01	20438-0**T-01	2496-0**	Au 0.10 μm MIN.
20437-0**T-11	20438-0**T-11		Au 0.30 μm MIN.

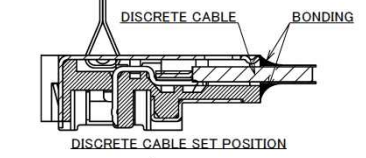
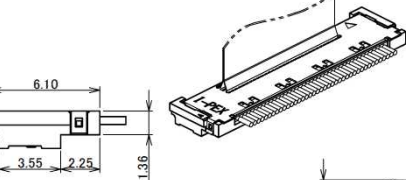
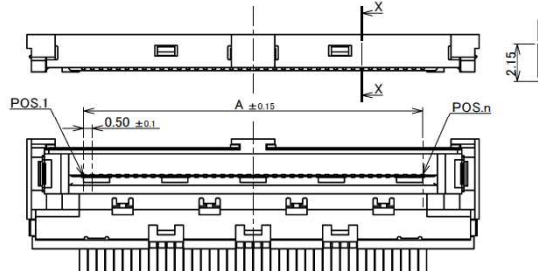
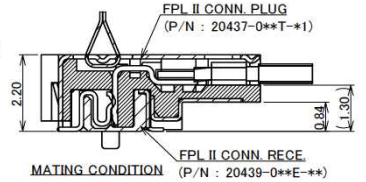
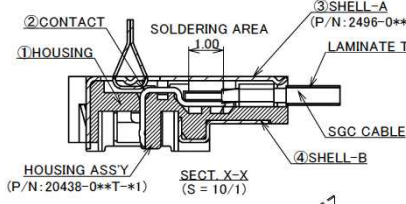
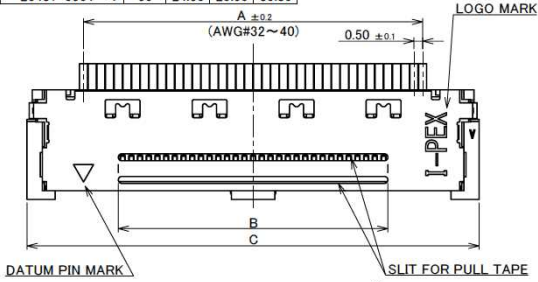

RECOMMENDED DIMENSION WHEN THE CABLE IS BENT

NO.	DISCRIPTION	MATERIAL	FINISH, REMARKS
4	SHELL-B	PHOSPHOR BRONZE	Sn 2.00 μm MIN. OVER Ni 1.00 μm MIN.
3	SHELL-A	PHOSPHOR BRONZE	Sn 2.00 μm MIN. OVER Ni 1.00 μm MIN.
2	CONTACT	PHOSPHOR BRONZE	PART NO. 20437-0**T-01 MATING AREA : Au 0.10 μm MIN. OVER Ni 1.00 μm MIN. OTHER AREA : Au 0.05 μm MIN. OVER Ni 1.00 μm MIN.
1	HOUSING	LCP	PART NO. 20437-0**T-11 MATING AREA : Au 0.30 μm MIN. OVER Ni 1.00 μm MIN. OTHER AREA : Au 0.05 μm MIN. OVER Ni 1.00 μm MIN.

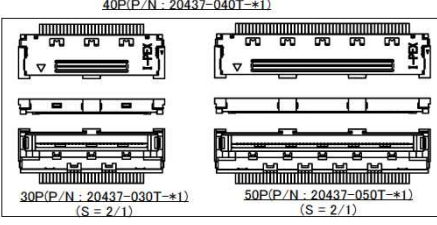

CAUTION VISIT OUR WEBSITE FOR LATEST VERSIONS OF INSTRUCTION MANUAL NO. HIM-09007 TO HANDLE THE PRODUCT PROPERLY AND SAFELY.
 ※DAI-ICHI SEIKO HP (<https://www.i-pex.com/ja/Products/detail/9>)

QKE-DFFDE06-02 REV.11

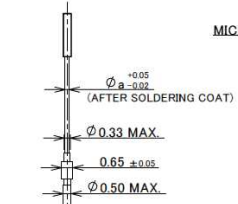
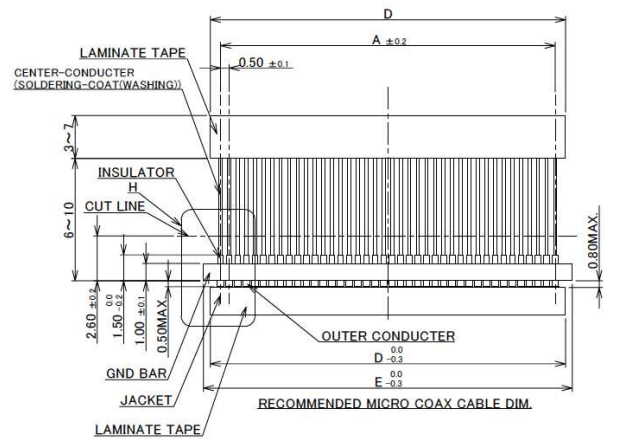

MICRO COAX CABLE DIMENSION

	a
#32	0.24
#34	0.192
#36	0.15
#38	0.12
#40	0.09

MICRO COAX CABLE #32, 34, 36 : NOT RECOMMENDED FOR HIGH SPEED SIGNAL TRANSFER

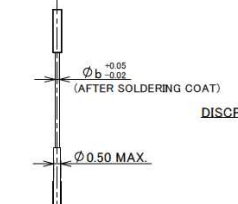
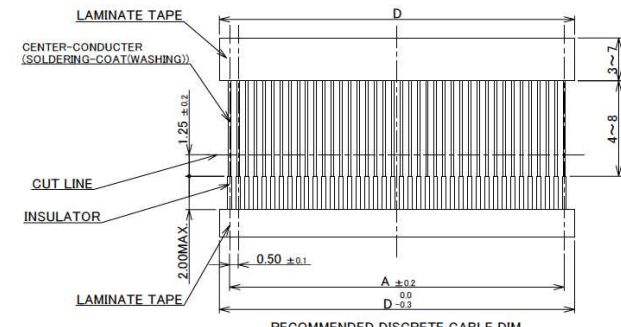

DISCRETE CABLE DIMENSION

	b
#32	0.24
#34	0.192
#36	0.15

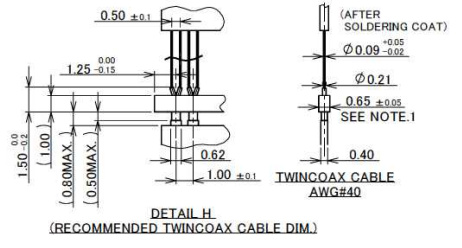

DETAIL H (RECOMMENDED TWIN COAX CABLE DIM.)

QKE-DFFDE06-02 REV.11



Plug Housing Assembly :

Recommended P/N		20438-0**T-01			
PART No.	POS.	A	B	C	D
20438-030T-*1	30	17.80	16.80	14.50	20.80
20438-040T-*1	40	22.80	21.80	19.50	25.80
20438-050T-*1	50	27.80	26.80	24.50	30.80

PART NO.	CONTACT FINISH (MATING AREA).
20438-0**T-01	Au 0.10 μm MIN.
20438-0**T-11	Au 0.30 μm MIN.

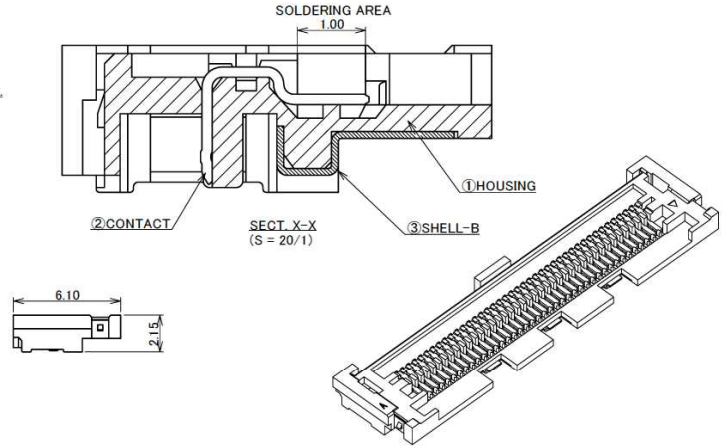
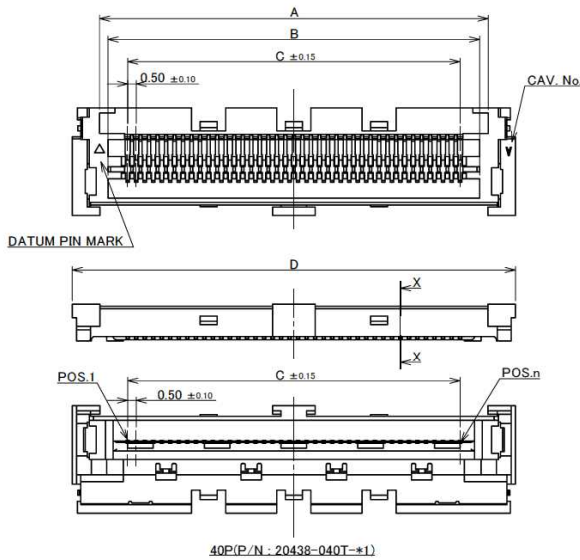

NOTES
1. THIS PART IS ASSEMBLE WITH SHELL-A(PART NO. 2496-0**)
AFTER SOLDERED THE CABLE. AND IT BECOMES PART NO. 20437-0**T-*1

NO.	DISCRIPTION	MATERIAL	FINISH , REMARKS
3	SHELL-B	PHOSPHOR BRONZE	Sn 2.00 μm MIN. OVER Ni 1.00 μm MIN. PART NO. 20438-0**T-01
2	CONTACT	PHOSPHOR BRONZE	MATING AREA : Au 0.10 μm MIN. OVER Ni 1.00 μm MIN. OTHER AREA : Au 0.05 μm MIN. OVER Ni 1.00 μm MIN. PART NO. 20438-0**T-11
1	HOUSING	LCP	UL94V-0, BLACK

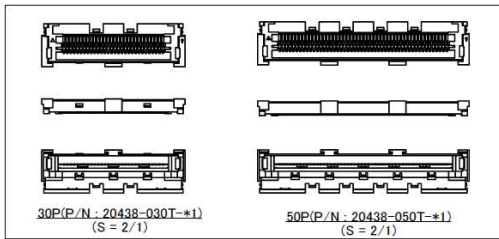

KQE-DFFDE06-02 REV.11

Plug Shell-A:

Recommended P/N		2496-0**			
PART NO.	Pos.	A	B	C	D
2496-030	30	10.00	30.00	20.24	35.00
2496-040	40	15.00	36.00	25.24	40.00
2496-050	50	20.00	40.00	30.24	45.00

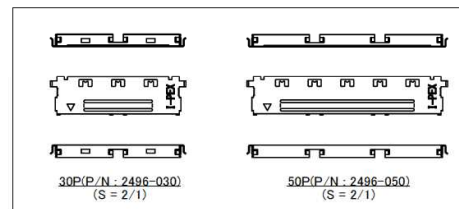
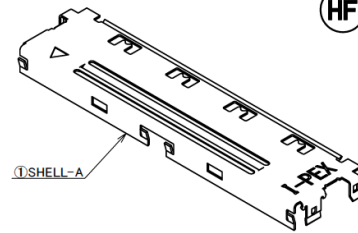
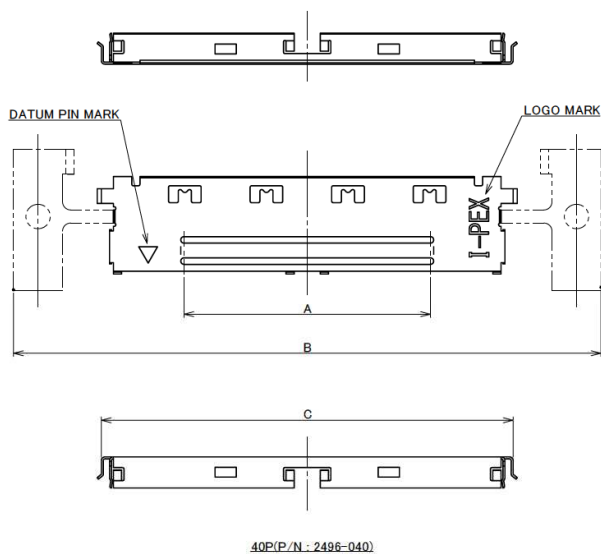

NO.	DISCRIPTION	MATERIAL	FINISH , REMARKS
1	SHELL-A	PHOSPHOR BRONZE	Sn(NO POLISH) 2.00 μm MIN. OVER Ni 1.00 μm MIN.

KQE-DFFDE06-02 REV.11

Receptacle Assembly :

Recommended P/N		20439-0**E-01				
PART NO.	Pos.	A	B	C	D	E
20439-030E-**	30	20.60	17.86	12.00	14.50	16.00
20439-040E-**	40	25.60	22.86	16.00	19.50	21.00
20439-050E-**	50	30.60	27.86	20.00	24.50	26.00



PART NO.	CONTACT FINISH (MATING SIDE)
20439-0**E-0*	Au 0.1 μm MIN.
20439-0**E-1*	Au 0.3 μm MIN.

PART NO.	BOSS	VACUUM CLIP
20439-0**E-#1	WITHOUT	WITH
20439-0**E-#2	WITH	WITH
20439-0**E-#3	WITHOUT	WITHOUT
20439-0**E-#4	WITH	WITHOUT

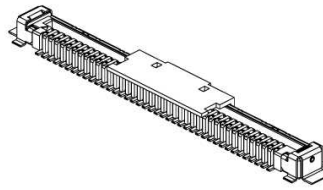
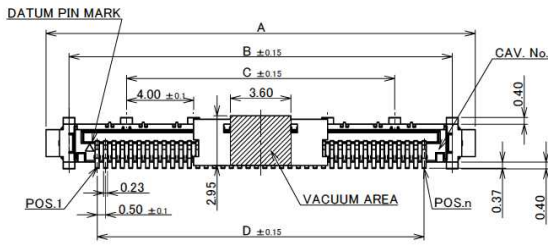

MATING COMBINATION TABLE

Pos.	PLUG PART NO.	RECE. PART NO.
30P	20437-030T-#1	20439-030E-**
40P	20437-040T-#1	20439-040E-**
50P	20437-050T-#1	20439-050E-**

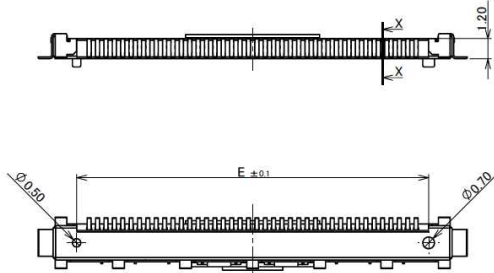
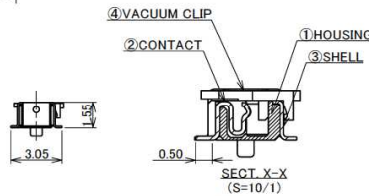
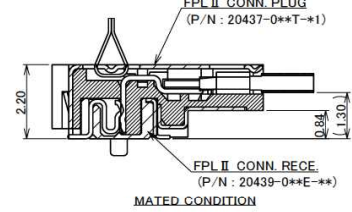

NO.	DISCRIPTION	MATERIAL	FINISH , REMARKS
4	VACUUM CLIP	LCP	UL94V-0, BEIGE
3	SHELL	PHOSPHOR BRONZE	Sn(NO POLISH) 0.50 μm MIN. OVER Ni 1.00 μm MIN.
2	CONTACT	PHOSPHOR BRONZE	PART NO. 20439-0**E-0* MATING AREA : Au 0.10 μm MIN. OVER Ni 1.00 μm MIN. OTHER AREA : Au 0.05 μm MIN. OVER Ni 1.00 μm MIN.
			PART NO. 20439-0**E-1* MATING AREA : Au 0.30 μm MIN. OVER Ni 1.00 μm MIN. OTHER AREA : Au 0.05 μm MIN. OVER Ni 1.00 μm MIN.
1	HOUSING	LCP	UL94V-0, BLACK

CAUTION VISIT OUR WEBSITE FOR LATEST VERSIONS OF INSTRUCTION MANUAL NO. HIM-09007 TO HANDLE THE PRODUCT PROPERLY AND SAFELY.
 ※DAI-ICHI SEIKO HP (<https://www.i-pex.com/ja/Products/detail/9>)

QKE-DFFDE06-02 REV.11

PART NO.	Pos.	B	C	D	E	F
20439-030E-**	30	17.86	12.00	14.50	16.00	18.60
20439-040E-**	40	22.86	16.00	19.50	21.00	23.60
20439-050E-**	50	27.86	20.00	24.50	26.00	28.60

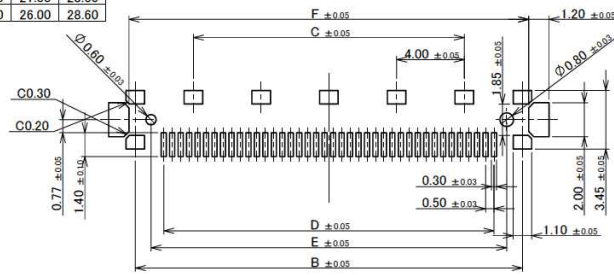

RECOMMENDED FOOTPRINT PATTERN LAYOUT

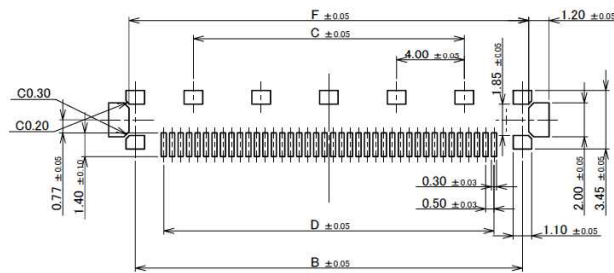

RECOMMENDED METAL MASK LAYOUT
 METAL MASK THICKNESS : t=0.12mm

QKE-DFFDE06-02 REV.11

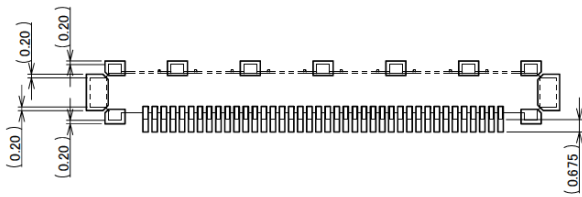

CONNECTOR ON RECOMMENDED FOOTPRINT PATTERN

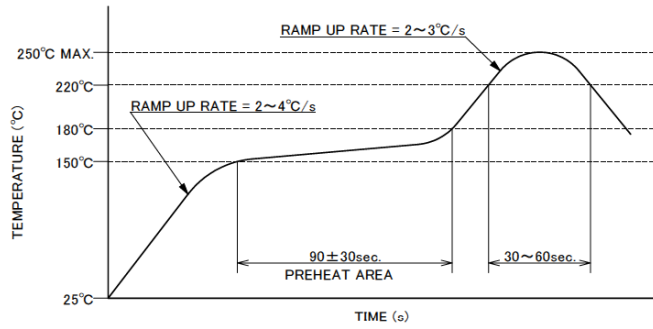

REFLOW TEMPERATURE PROFILE
 SENJU METAL INDUSTRY CO., LTD. : M705-SHF(Sn96.5 Ag3.0 Cu0.5)

QKE-DFE06-02 REV.11

ITEMS	SPECIFICATION
APPLICABLE CABLE	MICRO COAX : AWG# 40, 38, 36, 34, 32 DISCRETE : AWG# 36, 34, 32 TWINCOAX : AWG# 40
RATING VOLTAGE	100V AC (PER A CONTACT)
RATING AMPERAGE (FOR CONTACT)	0.3A AC/DC [AWG#40] AVAILABLE TO 50 Pin 0.6A AC/DC [AWG#38] AVAILABLE TO 6 Pin 0.8A AC/DC [AWG#36] AVAILABLE TO 4 Pin 1.0A AC/DC [AWG#34, 32] AVAILABLE TO 7 Pin TESTING BY REAL MACHINE IS RECOMMENDED BECAUSE TEMPERATURE RISE MAY AFFECTED BY ACTUAL SITUATION.
OPERATING TEMPERATURE	233~358K(-40°C~+85°C)
OPERATING HUMIDITY	85% MAX.(NON-CONDENSING)
CONTACT RESISTANCE	INITIAL : 145mohm MAX.(AWG#32) / AFTER TEST : \triangle 140mohm MAX. 185mohm MAX.(AWG#34) 210mohm MAX.(AWG#36) 335mohm MAX.(AWG#38) 575mohm MAX.(AWG#40)
GROUND SHELL RESISTANCE	INITIAL : 50mohm MAX. / AFTER TEST : \triangle 140mohm MAX.
INSULATION RESISTANCE	INITIAL : 1000Mohm MIN. / AFTER TEST : 500Mohm MIN.
DIELECTRIC WITHSTANDING VOLTAGE	AC250V 1min
DURABILITY	30 CYCLES
MATING FORCE (INITIAL / AFTER TEST)	30P : 50.0N MAX. / 40P : 60.0N MAX. / 50P : 70.0N MAX.
UNMATING FORCE (INITIAL / AFTER TEST)	30P : 5.0N MIN. / 40P : 6.0N MIN. / 50P : 7.0N MIN.
CABLE RETENTION FORCE	30.0N MIN.
COPLANARITY	0.10 MAX.
PRODUCT SPECIFICATION	PRS-1383
TEST REPORT	TR-07048
PACKING STANDARD	PLUG HOUSING ASS'Y : 300-584 / PLUG SHELL-A : 300-585
INSTRUCTION MANUAL	HIM-09007
ASSEMBLY MANUAL	ASM-07005

QKE-DFE06-02 REV.11



© DAI-ICHI SEIKO Co., Ltd. 2018. All rights reserved.

I-PEX is a trademark of DAI-ICHI SEIKO Co., Ltd. All other trademarks are owned by their respective companies. Please be noted that the contents in the catalog might be changed without prior notification. DAI-ICHI SEIKO Co., Ltd., assumes no responsibility for any inaccuracies or obligation to update Information on these documents. Please be sure to read and understand correctly the latest "Precautions for Use" and "Instruction Manual" before you use our products. We shall not be responsible for any defects, damages or troubles in case you use our products with not following the precautions for use. Please feel free to contact our sales representatives preliminarily when you use our products for any applications which require quite high reliability and safety, or which relate to human life. (ex. Nuclear power control, Aerospace, Transportation, Medical equipment, Safety equipment etc.)

www.i-pex.com

Contact your sales representative | Downloaded From Oneyac.com | 01.

201809R0

单击下面可查看定价，库存，交付和生命周期等信息

[>>I-PEX](#)